



# winco®

A LEADING ONE SOURCE FOODSERVICE SUPPLIER



2020

250 New  
Products!

WWW.WINCOS.COM

Although every effort has been made to provide our customers with the most accurate and complete information possible regarding products in this catalog, on our website, on Autoquotes, and any flyers and promotional material, informational mis-print may occur from time to time.

Winco® is not responsible for any such mis-prints of photos, descriptions or pricing.

# Why **Winco**®

*A leading ONE-SOURCE supplier, servicing the foodservice industry since 1992. Winco offers the widest range of high-quality products at the lowest prices with absolute dedication to service.*

Our ambition is to inspire the way you think about your establishment, by delivering innovative, functional products that span from the front of the house, to the back, Winco® has what your business needs to function at its best.

Our ever-growing product assortment is manufactured to meet the rigorous standards of foodservice establishments and bakeries, a testament to our vision: Users deserve reliable, affordable, high-quality products that withstand tough, busy kitchens with ease. At Winco **we are committed to ensuring that our products meet and exceed all industry standards.**

Today, Winco is a **leading supplier for restaurant smallwares and light equipment**, serving the USA, North, Central and South America, & European markets. Winco operates distribution centers in Florida, New Jersey and California to be able to supply you with fast shipping, full stock availability and outstanding customer service from coast to coast.

We have a caring and attentive customer service department ready to support you with all your needs.

Our sales force can help you create solutions for your specific challenges, and is ready to assist in making product recommendations that are perfectly suited to you.

## *Facilities in New Jersey, California and Florida*

Winco® now operates distribution centers in Florida, New Jersey and California to be able to supply you with fast shipping, full stock availability and outstanding customer service from coast to coast.

### *Lodi, New Jersey - Headquarters*



### *Miami, Florida - Distribution and Showroom*



### *La Mirada, California - Distribution Center*



## **WHY WINCO**

- ☑ +5,000 products
- ☑ 3 distribution centers, 500,000 square feet of inventory
- ☑ More than 80 sales representatives covering North America

## Front of House

Dining & Service

17

### Dinnerware 18-39

<b>Ardesia™</b> Porcelain	18-27
<b>Ardesia™</b> Melamine	28-37
<b>Ardesia™</b> Slate	37
Classic Melamine	38-39

### Cadenza™ 40-45

Monte Carlo™	Claret™
Isola™	Carrera™
Ampezzo™	Aires™

### Flatware & Steak Knives 46

18/8 Flatware	Hollow Handle Knives
18/0 Flatware	Steak Knives

### Chafers & Buffet Service 64

Chafers & Accessories	Juice Dispensers
Chafing Fuel	Serving Trays & Utensils
Coffee Urns	Signs-Clip, Chain, Tent
Electric Water Pan	<b>VIRTUOSO™ Chafers</b>

### Tabletop 82

Condiment Dispensers and Sauce/Dessert Cups	Salt Shakers
Fajita Servers & Sizzle Platters	Seafood Trays
<b>FireIron™ Mini Cast Iron</b>	Serving Baskets- Plastic, Woven Poly, Wire
Glass Shakers & Caddies	Serving Boards & Trays
<b>Maestro™ Pepper Mills</b>	Snail Server
Mini Baskets & Cups	Sugar & Creamers
Mini Cans & Pails	Taco & Salsa/Dip Service
Mini Cookware/Serveware	Tortilla Presses
Salad Bowls	

### Dining Service 100

Cafeteria/Mess Trays	Order Racks & Check Service
Call Bells & Crumbers	Seafood/Snail Service
Cheese Knives	Serving Trays & Stands
Coat Check	Signs-
Condiment Dispenser	Stanchion Floor Stands, LED, Information, Braille
Cotton Gloves	Squeeze Bottles
Decorative Picks	Straw & Napkin Dispensers
Display Boards & Easels	Table Covers
Electric Tealights	Table Signs & Clips
Flatware Organizers	<b>STABLEizer™ Wedges/Shims</b>
Graters, Zesters & Peelers	Wine Service
Menu Covers & Stands	

### Beverage Service 124

Airpots & Racks	Juice Dispensers
Beverage Dispensers	Pitchers-
Coffee & Tea Accessories	Plastic, Stainless Steel
Coffee Warmers-Single, Double	Plastic Drinkware
Cup & Lid Organizers/Racks	Punch Bowl
Drip Trays	Signs - Hanging or Tent
French Press	<b>Virtuoso™ Coffee Urns &amp; Juice Dispenser</b>
Insulated Servers	

### Display 134

Angled Adaptor	Display Boards & Easels
Cake/Dessert Stands	Risers, Bowls & Trays-
Display Cases/Covers	Acrylic, Plastic, S/S
Crocks & Covers-Plastic	Roll-Top Food Pan Cover

### Bar Supplies 140

Bar Clean-Up	Insulated Ice Caddy
Bar Liners & Service Mats	Muddlers & Squeezers
Bar Speed Rails	Moscow Mule Mugs
Beer Mug Washer	Non-Slip Trays
<b>ACCELMIX™ Blenders</b>	Overhead Glass Racks
Bottle Openers & Corkscrews	Pour Bottles
Condiment Holders	Pourers & Stoppers
Drink Prep & Ice Tools	Syrup/Liqueur Pump Kit
	Wine Service

## Kitchen

Prep & Cook

157

### Signature Chef™ Apparel 158

Chef Jackets, Shirts, Pants- Multiple Fits & Sizes	Aprons - Bib & Waist Hats - Cloth & Disposable
---	---

### Professional Cutlery 169

<b>ACERO™ Forged Cutlery</b>	Protective Gloves
<b>BladeStation™</b>	Sharpening Tools
Cheese Knives, Wires, Graters	Shears-Poultry & Herb
Cook's/Pot Forks	Specialty & Pizza Knives
<b>COOL HEAT™ Turners</b>	<b>STAL™ Stamped Cutlery</b>
Knife Storage/Transport	Steak Knives
Professional Cleavers	<b>Sof-Tek™ Stamped Cutlery</b>

### Professional Cookware 197

Aluminum Cookware	Pan Sleeves & Grabbers
Cast Iron Griddles	Roasting Pans
<b>FIREIRON™ Cast Iron Skillets</b>	Stainless Steel Cookware
Fryer & Pasta Baskets	<b>TRI-GEN™ Induction-Ready</b>

### Steam Table Pans 224

Adaptor Bars & Plates	Water & Spillage Pans
False Bottoms	Wire Steam Pan Grates
Specialty Pans & Covers	<b>WINCO PRIME™ Bain Maries</b>

### Poly Pans & Food Storage 231

Beverage Container	Food Pans & Covers- Clear & White PC
Dough Boxes, Covers, Dolly	Ingredient Bins & Lids- Mobile, Stackable
Drain Shelves, Colanders	
Food Storage Containers- Round, Square, Clear, Translucent, White	

### Bakeware 238

Baking Mats, Silicone	Mixing Tools- Paddles, Spoons & Bowls
Batter Dispensers & Funnels	Muffin & Loaf Pans
Cake Decorating Tools	Pastry Tools-
Cake Pans-	Brushes, Blenders, Wheels, Cutters & Molds
Round & Rectangle	Rolling Pins
Cookie Sheet & Cutters	Scrapers-Silicone & Plastic
Cooling Racks & Grates	Spatulas
<b>CONNOISEUR™ Pastry Blender</b>	Sheet Pans
Dough Preparation-	Sheet Pan Racks
Boxes & Lids, Proofing Pans, Dockers, Scrapers	Sifters & Sieves
Doughnut Basket	Specialty Pans- Tart, Bundt, Baguette & Bread Form
Dredges & Lids	Springform Pans
Leveler, Markers, Cutters	Timers, Oven Mitts, Pot Holders
Measuring Tools- Cups, Spoons & Ladles	

### Pizza Supplies 265

Bubble Poppers	Pan Grippers
Dough Preparation-	Perforated Disks
Boxes, Sifter, Scrapers, Mixing	Pizza Knives/Cutters Pizza Pizza
Paddles, Rolling Pins	Pans-Deep Dish, Round, Sicilian & Stackable
Dredges & Lids	Peels-Aluminum & Wood
Heat Sink	Servers & Tongs
Insulated Delivery Bags	Tabletop Stand & Rack
Mesh Screens	
Oven Brushes	

### Food Preparation 274

Commercial Can Openers	Manual Prep Tools
Colanders	Mixing Bowls & Stand
Countertop Juice Squeezers	Pasta Maker
Cutting Boards & Mats	Salad Spinners
Dispensers-	Scales
Batter & Condiment	<b>STATIKBOARD™ Cutting Boards</b>
Food Mills	Thermometers
<b>KATTEX™ Slicers &amp; Cutters</b>	Tortilla Press
Mandoline Slicers & Blades	Utility Pail

**Kitchen Utensils 295**

**ALLERGEN-FREE™ Tools**  
 Basting Covers & Utensils  
 Butter Roller  
 Cook's Forks  
 Culinary Baskets  
 Egg Tools  
 Fryer Accessories  
 Fruit Prep Tools  
 Funnels & Dispensers  
 Graters, Zesters & Peelers  
 Ladles & Dippers  
**CONNOISSEUR™ Pasta Baskets**  
 Measuring Cups & Spoons  
 Meat Prep Tools  
 Mixing/Stirring Paddles  
 Plating Molds & Utensils

Protective Gloves  
 Scoops & Rack  
 Scrapers-Plastic & Nylon  
 Serving Tongs-  
 Poly, Heat-Resistant &  
 Stainless Steel  
 Seafood Prep Tools  
 Shears-Herb & Poultry  
 Silicone Brush  
 Spatulas/Turners  
 Spoons-Nylon & Wood  
 Squeeze Bottles  
 Strainers & Strimmers  
 Whips, Stainless Steel  
**WINCO PRIME™ Series**

**Back of House 334**  
*Clean & Organize*

**Janitorial 335**

Broom Heads, Handles & Sets  
 Brushes-Oven & Utility  
 Cleaning Accessories, Towels  
 Floor Care & Floor Mats  
 Gloves & Wall Brackets  
 Grill Maintenance

Hood Filters  
 Insect Control  
 Janitorial Accessories  
 Restroom Necessities  
 Trash Cans, Lids, Dollies,  
 Receptacle & Wire Cart

**Shelving & Racks 355**

Dunnage Racks

Wire Shelving, Sets &  
 Accessories

**Bussing & Transport 360**

Bus/Dish Boxes & Carts  
 Casters, Universal  
 Dish/Tray Caddy  
 Flatware Organizers

Hot/Cold Food Transporters  
 Ingredient Bins  
 Sheet Pan/Steam Pan Racks  
 Wire Dolly

**Equipment 371**  
*Prep, Cook, Hold & Merchandise*

**Countertop Equipment 372**

**ACCELMIX™ Blenders**  
 Beverage Displays-  
 Refrigerated  
 Butane Gas Stove, Portable  
 Coffee Warmers-  
 Single, Double, Tiered  
 Coffee Urns  
 Commercial Can Openers  
 Convection Ovens  
 Deep Fryers  
 Electric Water Pan  
 Food Cooker/Warmers -  
 Rectangular & Round  
 Heat Lamps  
 Heated Merchandisers  
 Induction Cooker  
**KATTEX™ Slicers & Cutters**  
**Panasonic® Rice Cooker**  
 Pizza Oven, Electric  
 Rice Cookers/Warmers

**ROLLSRIGHT™**  
 Sandwich Grills  
**SHOWTIME!™ -**  
 Cotton Candy Machines  
 Popcorn Poppers  
 Soup Warmers  
**SPECTRUM™ -**  
 Charbroilers  
 Conveyor Toaster  
 Griddles  
 Hot Dog Roller Grills  
 Hot Plates  
 Induction Cookers  
 Microwaves  
 Sous Vide Equipment  
 Stock Pot Stove  
 Vacuum Sealer  
 Strip Heaters  
 Universal Dump Station Holder  
 Water Boilers

**Index 406**

**Apparel Sizing Charts 416**

**Icons/Symbols**

Look for these symbols throughout the catalog:



New product introduced since last catalog



Product is packed in display-ready retail packaging (color box, color blister pack, hang tag, etc.)

**Certifications**



Product is NSF® certified and complies with all food safety standards



Product is listed in the CSA® Group Certified Product Listing



Product is ETL™ certified for compliance with accepted national safety standards for USA and Canada



Product is ETL™ certified for compliance with sanitation/food safety standards



Product is UL® certified for compliance with safety standards



Product is UL® certified to be compliant with safety standards for U.S.A. and Canada



Energy Verified  
 Rendement  
 Énergétique Vérifié

Product is UL® certified to be compliant with energy efficiency standards



Product conforms with European standards



Product is color-coded for Allergen-Free



Product does not contain Bisphenol-A (BPA)



Product does not contain Perfluorooctanoic Acid (PFOA)



Product is compatible with induction cookers

Most orders less than pallet loads will be shipped by UPS. Look for these shipping icons to guide freight evaluations.



Additional oversize fee applies if item ships via UPS®



Item cannot be shipped by UPS®

All product photography © 2020 Winco®  
 DWL International Trading, LLC

## winco® FIRE IRON™ Cast Iron

Artfully present single-serve portions in mini enameled, induction ready, cast iron cookware.

Designed to last generations, FireIron cast iron pans are pre-seasoned or enameled and induction ready.

Great for kitchen-to-table service.



### FIREIRON™ SINGLE-SERVE MINI CAST IRON COOKWARE

ENAMELED

INDUCTION  
READY



CAST-3  
3 OZ



CAST-5  
7 OZ



CASM-5R  
12 OZ



CASM-6R  
14 OZ



CASM-6O  
9 OZ



CASM-7O  
16 OZ



Lip under each handle  
allows for easy handling  
and good grip



CASM-4S  
10 OZ



CASM-5RT  
10 OZ



CASM-7RT  
14 OZ

P.82





**FIREIRON™ FULL-SIZE CAST IRON COOKWARE**

**PRE-SEASONED**



CAGP-10S



CAGP-10R



Thumbrest



Wide handles



CASD-8



CASD-10



CASD-12

**P.209**

### ELITE PATTERN FLATWARE IN CLEAR-VIEW PACK



0083-SERIES



P.61

### TORTILLA WARMER



PTW-7K



HOLDS 8  
TORTILLAS

AVAILABLE IN  
JULY 2020

P.91

### BLACK WIRE CADDY

WH-3K



Use with  
G-104

P.92

### DECORATIVE BAMBOO PICKS



PK-KT SERIES



100 pieces per  
hanging bag



P.107  
&141

### SERVER BOOK WITH CLEAR SLEEVE



CHK-3K

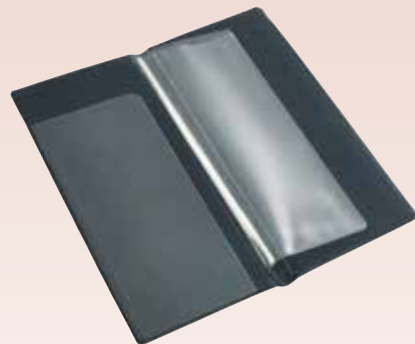

P.111

### "NO SOLICITING" INFORMATION SIGN



SGN-336

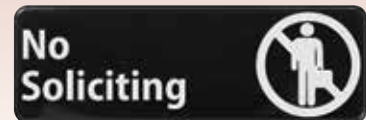

P.120

### OVERSIZED METAL POURER



PPM-6



MEDIUM  
FLOW

P.151





### VIRTUOSO™ JUICE DISPENSER

908

CHILL WITH ICE CORE



P.74 &124

### TAPERED MEN'S CHEF JACKETS

UNF-10G-SERIES

UNF-6R-SERIES

AVAILABLE IN AUGUST 2020

AVAILABLE IN AUGUST 2020



Roll-tab sleeves



NEW COLORS

P.158 -159

### TAPERED FIT VENTILATED SHIRTS

UNF-9-SERIES

AVAILABLE IN AUGUST 2020



UNF-9K3XL

COOL MESH



UNF-9W3XL

COOL MESH

NEW SIZE

P.160

### BEVERAGE DISPENSER WITH ICE CORE

904

CHILL WITH ICE CORE



P.75 &125

### CARGO CHEF PANTS

UNF-11K-SERIES

AVAILABLE IN AUGUST 2020



P.161

### 3-POCKET WAIST APRON

WA-1221RED

NEW COLOR



P.116 &165

### HEAD WRAP

CHHW-3K



P.167

### VENTILATED PILLBOX HAT

CHPB-3R-SERIES

NEW COLOR

COOL MESH



AVAILABLE IN JULY 2020

P.167

The **only** cutlery endorsed by American Master Chefs' Order



"We only put our signature on something we *Truly believe in*.... something that has **QUALITY** and a **HIGH STANDARD.**"



KFP-SERIES

P.169  
-173

### SOF-TEK™ PIZZA CUTTER



KSTK-40



P.192  
&268

### BLADE STATION™ KNIFE SHARPENER & SHARPENING RODS



KSP-6

KSP-6W  
(REPLACEMENT  
SHARPENING ROD)

## BLADE STATION™



#### TIME SAVING



4 Swipes to  
Ideal Sharpness

#### MOVABLE

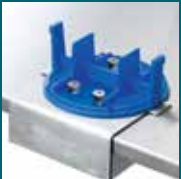

Easily transport  
to any worktop



P.182

### ANTI-MICROBIAL CUT-RESISTANT GLOVES



GCRA-SERIES

AVAILABLE IN  
JULY 2020



S, M, L, XL  
SIZES

P.185

### STÄL BREAKING AND BUTCHER KNIVES



KWP-SERIES



KWP-82

KWP-102

KWP-124



P.177  
&178

### NEOPRENE POT HOLDER

PH-8N

AVAILABLE IN  
JULY 2020



P.261

### GLAZED PULLMAN PANS & LIDS

HPP-SERIES

PANS & LIDS  
SOLD  
SEPARATELY



P.246

### FULLY PERFORATED GLAZED ALUMINUM SHEET PANS

ALXN-SERIES

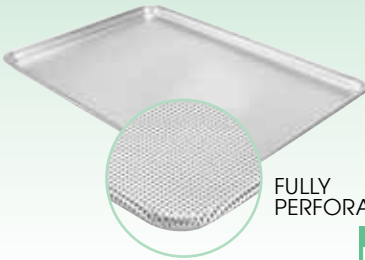

FULLY  
PERFORATED

P.238

### ALUMINUM SHEET PAN

ALXP-1204

NEW  
SIZE NSF



OPEN  
BEAD

P.238

### NSF® CERTIFIED MANUAL CAN OPENER

CO-3N

NSF



P.274  
&372

### CUTTING BOARD MOUNT FOR FRUIT & VEGETABLE SLICER

STATIKboard™  
CBM-1218

NSF



PATENTED  
ORIGINAL  
DESIGN

KATTEX™  
FVS-1 & CBM-1218



P.275  
&373

### THERMOMETERS

AVAILABLE IN  
AUGUST 2020



TMT-HH1

NSF



TMT-IO1

P.288  
-289

### WHIPPED CREAM DISPENSER

CW-A05

BPA  
FREE

Three (3)  
decorating  
tips

CARTRIDGE  
NOT INCLUDED



P.253,  
281,  
&298

### NEOPRENE OVEN MITTS

OMNP-SERIES

AVAILABLE IN  
JULY 2020



P.261

### ALUMINIZED STEEL LOAF PANS WITH SILICONE GLAZE

HLP-SERIES

PFOA  
FREE



P.246

### POLYCARBONATE FOOD STORAGE BOX & COLANDERS

PFSF-SERIES

NSF

AVAILABLE IN  
JULY 2020



18"X26"X3"

NEW  
SIZE

P.234

### VEGETABLE CLEANING BRUSH

BRV-10

**BPA FREE**



P.292 &348

### 3LB STEAK WEIGHT WITH SILICONE SLEEVE

SWS-94

Nested together for additional weight

**NSF**

**NEW SIZE**



**PATENTED**

P.330

### 10 OZ ONE-PIECE STAINLESS STEEL LADLE

LDI-10



P.305

### BOTTLE CLEANING BRUSH

BRB-12

**BPA FREE**



P.292 &348

### COUNTER CLEANING BRUSH

BRC-14Y

**BPA FREE**



**AVAILABLE IN JULY 2020**

P.348

### NAIL CLEANING BRUSH

BRN-52



**AVAILABLE IN JULY 2020**

P.348

### TOILET BRUSH WITH WOODEN HANDLE

BR-21W



P.353

### TOILET BRUSH WITH CADDY

BR-15SET



P.353

### 10 QT & 14 QT UTILITY PAILS

UPP-SERIES

**BOTH SIZES IN RED OR GRAY**



Molded-in graduation marks

P.347

### CELLULOSE & SCRUB SPONGES



SP-C64Y

SP-SC63

P.348

### PLASTIC SPRAY BOTTLES

PSR-SERIES

**IDEAL FOR COLOR-CODED CLEANING SYSTEMS**



**NEW COLORS**

P.346

### JANITORIAL CADDY

PJC-1511K



P.338

JANITORIAL CADDY BAG

JCB-2920

MULTIPLE POCKETS FIT A VARIETY OF CLEANING SUPPLIES



P.338

SLENDER TRASH CAN & LID - COMPOST

PTC-23GRC & PTCL-23GR



P.336

ROUND TRASH CAN & LID

PTCR-22G & PTCRL-22G



P.339

JANITORIAL CADDY FOR 44 GALLON CONTAINER

TCD-44Y



P.338

SQUARE TRASH CANS & LIDS

PTCS-SERIES



P.339

WASTE BASKETS

PWR-SERIES



P.336

### 36 QT MOP BUCKET WITH SIDE-PRESS WRINGER

MPB-SERIES

**NEW COLOR**

SIDE-PRESS WRINGERS AND BUCKETS AVAILABLE AS A SET OR SEPARATELY



P.340

### PREMIUM ANGLED BROOM HEADS, HANDLES & SETS

BRF-6K-H, BRAF-SERIES, BRAU-SERIES



48" L HANDLE

30" L HANDLE

AVAILABLE IN JULY 2020

BRAF-9R-H Flagged

BRF-6K-H Flagged

P.343

### JUMBO DUST PAN

DP-14R

RUBBER BLADE EDGING



P.344

### LARGE DUST PAN

DP-1618K

RUBBER BLADE EDGING



P.344

### SUPERIOR MICROFIBER LOOP-END WET MOPS

MOPM-SERIES



Looped ends prevent unraveling



P.341

### PUSH BROOMS

BRFF-SERIES BRFC-SERIES



COARSE



FINE

AVAILABLE IN JULY 2020

P.343

### FIBERGLASS BROOM HANDLES

BRH-SERIES

AVAILABLE IN JULY 2020

AVAILABLE IN 48" & 60" L



P.343

### DISPENSER FOR BRICK PACKS

MOPR-22



P.341

### DUST MOP REFILLS

MACHINE WASHABLE

DMM-SERIES

Microfiber blend



DMB-SERIES

Cotton blend

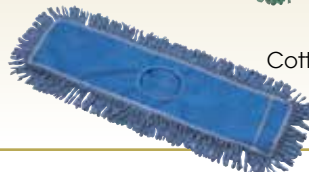

P.342

### DUST MOP SET, MOP HEAD, FRAMES & HANDLE

DM-SERIES

60" L HANDLE

MACHINE WASHABLE



24" & 36" frames

P.342

**ANTI-FATIGUE RUBBERIZED GEL FOAM FLOOR MAT**

FMG-23K



**1/2" THICK**

**P.335**

**DISPOSABLE VINYL GLOVES**

GLV-SERIES



**AVAILABLE IN JULY 2020**

**P.345**

**DISPOSABLE NITRILE GLOVES**

GLN-SERIES



**AVAILABLE IN JULY 2020**

**P.345**

**GLOVE BOX HOLDER**

WHW-11

**NEW SIZE**



**P.345**

**12-TIER STAINLESS STEEL STEAM TABLE PAN/FOOD PAN RACKS**

SRK-SERIES



**UNDER COUNTER HEIGHT**



**P.230, 243, &364**

**FOLDING UTILITY CARTS**

UCF-SERIES

**ONLY 8" WIDE WHEN FOLDED**



**P.368**

**STATIONARY 9-TIER CAN STORAGE RACK**

ALCR-9

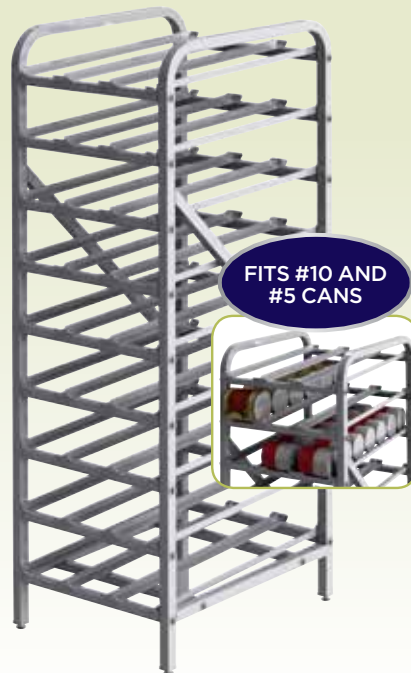

**P.359**

**MOBILE UNDER-COUNTER CAN STORAGE RACK**

ALCR-3M

**AVAILABLE IN JULY 2020**

**UNDER COUNTER HEIGHT**

**FITS #10 AND #5 CANS**



**P.359**

**20-TIER ALUMINUM ECONOMY STORAGE RACK**

ALRK-20R



20-TIER  
KNOCKED  
DOWN



P.241  
&361



**30-TIER ALUMINUM SHEET PAN RACK**

AWRK-30



30-TIER  
WELDED



P.241  
&361

**SPECTRUM™ IMMERSION CIRCULATOR**

ESVI-1



P.394

**SPECTRUM™ VACUUM SEALER**

EVPM-12



P.395

**SPECTRUM™ THERMAL CIRCULATOR**

ESVC-28



P.394

**SPECTRUM™ SOUS VIDE ACCESSORIES**

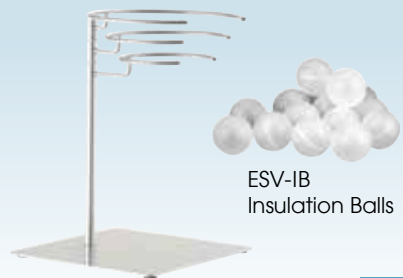

ESV-IB  
Insulation Balls

ESV-BH  
Bag Stand

P.395



## SPECTRUM™ HOT DOG ROLLER GRILLS & SNEEZE GUARDS

EHDG-SERIES



P.380

## ECONOMY INDUCTION COOKER

EIC-400E



LOW PROFILE



P.72  
&392

## SPECTRUM™ COUNTERTOP INDUCTION COOKERS

EICS-34



EICS-18



EICS-18C



P.73  
&392

## SPECTRUM™ ELECTRIC GRIDDLES

EGD-SERIES



P.404



## SPECTRUM™ DROP-IN INDUCTION COOKERS

EIDS-34



EIDS-18



EIDS-18C



P.72  
&393

## SPECTRUM™ GAS HOT PLATES

NGHP-SERIES



P.405

## SPECTRUM™ GAS CHARBROILERS

NGCB-SERIES



P.406

## SPECTRUM™ GAS GRIDDLES

NGGD-SERIES



P.407

### SPECTRUM™ COUNTERTOP CONVEYOR TOASTER & STACKING KIT

ECT-SK



VERTICALLY STACK 2 TOASTERS

ECT-700



700 SLICES PER HOUR



P.398

### STAINLESS STEEL COFFEE URNS

ECU-SERIES

AVAILABLE IN JULY 2020



CE ECU-100A-I

P.385

### STAINLESS STEEL WATER BOILERS

EWB-SERIES

AVAILABLE IN JULY 2020



CE EWB-100A-I

P.386

### UNIVERSAL DUMP STATION PAN HOLDERS

EHL-PH-SERIES  
Black or Gray



COMPATIBLE WITH WINCO® HEAT LAMPS



P.390

### 3-POSITION STEEL TUBING ELECTRIC HEAT LAMP

EHL-3C

NEW COLOR



P.391

### CART FOR POPCORN POPPER

POP-8RC

POPCORN

POP-8RC-D Decal

Show Time!



P.379

### COTTON CANDY MACHINE WITH CART

CCM-28M

Show Time!



CCM28-P1 Cotton Candy Machine Floss Stabilizer



P.378

### CAST IRON FLAT TOP GRIDDLE PLATE

EPSG-RF1C (FOR EPG-1C)

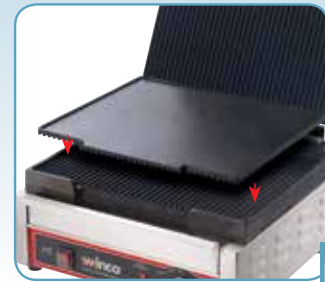

P.401

### HEATED & HUMIDIFIED DISPLAY MERCHANDISER

EDM-1K



P.383

# FRONT OF HOUSE

*Dining & Service*



# PORCELAIN

Start a new collection or build on existing tableware with the versatile **porcelain** collections from Ardesia™ by Winco®. Find inspiration in the clean lines, bright whites and geometric forms that effortlessly assist culinary creation and presentation. Discover the wide range of porcelain selections from Ardesia™ by Winco® to achieve the perfect setting. **Dishwasher Safe.**



**ZENDO™** *A Touch of Contemporary Linear Embossment*

Bright White Porcelain

ITEM	DESCRIPTION	SIZE	CAPACITY	UOM	QTY/CASE
A	WDP022-101	Wide Rim Bowl	7-1/4" Dia	3 Oz	Case 36-Pcs
B	WDP022-102	Wide Rim Bowl	9" Dia	6 Oz	Case 24-Pcs
C	WDP022-103	Wide Rim Bowl	10-1/2" Dia	10 Oz	Case 12-Pcs
D	WDP022-104	Wide Rim Bowl	12" Dia	14 Oz	Case 12-Pcs
E	WDP022-105	Round Plate	6-1/2" Dia		Case 48-Pcs
F	WDP022-106	Round Plate	8-1/8" Dia		Case 36-Pcs
G	WDP022-107	Round Plate	9" Dia		Case 24-Pcs
H	WDP022-108	Round Plate	10" Dia		Case 24-Pcs
I	WDP022-109	Round Plate	11-1/8" Dia		Case 12-Pcs
J	WDP022-110	Round Plate	12-1/8" Dia		Case 12-Pcs
K	WDP022-111	Coffee Cup	3-1/4" Dia	6 Oz	Case 36-Pcs
L	WDP022-112	Round Saucer	6" Dia		Case 36-Pcs

**OCEA™** *A Combination of Modern and Traditional*

Creamy White Porcelain

ITEM	DESCRIPTION	SIZE	CAPACITY	UOM	QTY/CASE
M	WDP004-201	Oval Plate	8" L		Case 24-Pcs
N	WDP004-202	Oval Plate	10" L		Case 24-Pcs
O	WDP004-203	Oval Plate	12" L		Case 12-Pcs
P	WDP004-204	Oval Plate	14" L		Case 12-Pcs
Q	WDP004-205	Oval Rim Rnd Bowl	4" Dia	3 Oz	Case 36-Pcs
R	WDP004-206	Oval Rim Rnd Bowl	6" Dia	10 Oz	Case 24-Pcs
S	WDP004-207	Oval Rim Rnd Bowl	8" Dia	20 Oz	Case 24-Pcs
T	WDP004-208	Oval Rim Rnd Bowl	10" Dia	50 Oz	Case 12-Pcs
U	WDP004-209	Oval Dish	10" x 7-7/8"		Case 24-Pcs
V	WDP004-210	Oval Dish	12" x 9-1/8"		Case 12-Pcs
W	WDP004-211	Oval Dish	14" x 10-1/4"		Case 12-Pcs
X	WDP004-212	Oval Dish	16" x 12-1/4"		Case 6-Pcs
Y	WDP004-213	Oval Dish	18" x 13-5/8"		Case 6-Pcs
Z	WDP004-214	Coffee Cup	3-1/2" Dia	6 Oz	Case 36-Pcs
AA	WDP004-215	Oval Saucer	6-1/4" x 5-1/2"		Case 36-Pcs



# FALETTE™ *The Natural Wave*

Bright White Porcelain

ITEM	DESCRIPTION	SIZE	UOM	QTY/CASE
A	WDP010-101	Square Plate	9" Sq	Case 12-Pcs
B	WDP010-102	Square Plate	10" Sq	Case 12-Pcs
C	WDP010-103	Square Plate	12" Sq	Case 6-Pcs



# CRAMONT™ *The Windmill*

Bright White Porcelain

ITEM	DESCRIPTION	SIZE	UOM	QTY/CASE
D	WDP011-101	Square Plate	6" Sq	Case 36-Pcs
E	WDP011-102	Square Plate	7-1/2" Sq	Case 24-Pcs
F	WDP011-103	Square Plate	9-1/4" Sq	Case 12-Pcs



# BETTINI™ *The Timeless Unparalleled Rim*

Bright White Porcelain

ITEM	DESCRIPTION	SIZE	UOM	QTY/CASE
G	WDP009-101	Square Plate	7-1/2" Sq	Case 24-Pcs
H	WDP009-102	Square Plate	10-1/2" Sq	Case 12-Pcs
I	WDP009-103	Square Plate	14" Sq	Case 6-Pcs



# MAZARRI™ *Uniquely Engraved*

Bright White Porcelain

ITEM	DESCRIPTION	SIZE	UOM	QTY/CASE
J	WDP007-101	Round Plate	10" Dia	Case 12-Pcs
K	WDP007-102	Round Plate	11" Dia	Case 12-Pcs
L	WDP007-103	Round Plate	12" Dia	Case 12-Pcs



J K L

# CARZOLA™ *The Elevated Creativity*

Bright White Porcelain

ITEM	DESCRIPTION	SIZE	CAPACITY	UOM	QTY/CASE
M	WDP005-101	Square Bowl	6-1/4" Sq (5-1/2" Dia)	4 Oz	Case 36-Pcs
N	WDP005-102	Square Bowl	7-3/4" Sq (6-3/4" Dia)	10 Oz	Case 24-Pcs
O	WDP005-103	Square Bowl	10" Sq (8-1/2" Dia)	22 Oz	Case 12-Pcs



O N M

# BERGOMI™ *The Cozy Curve*

Creamy White Porcelain

ITEM	DESCRIPTION	SIZE	CAPACITY	UOM	QTY/CASE
P	WDP006-201	Oval Plate	8" L	Case	36-Pcs
Q	WDP006-202	Oval Plate	10-1/4" L	Case	12-Pcs
R	WDP006-203	Oval Plate	12-1/2" L	Case	12-Pcs
S	WDP006-204	Oval Bowl	8" L	6 Oz	Case 36-Pcs
T	WDP006-205	Oval Bowl	11" L	14 Oz	Case 12-Pcs
U	WDP006-206	Oval Bowl	13" L	20 Oz	Case 12-Pcs



S

P

Q

R



## RIMINI™ *The Imperfect Perfection*

Creamy White Porcelain

ITEM	DESCRIPTION	SIZE	CAPACITY	UOM	QTY/CASE
A	WDP003-201 Angled Bowl	6-1/2" Dia	0.5 Qt	Case	36-Pcs
B	WDP003-202 Angled Bowl	8-1/4" Dia	1 Qt	Case	12-Pcs
C	WDP003-203 Angled Bowl	9-1/2" Dia	1.5 Qt	Case	12-Pcs
D	WDP003-204 Angled Cup	5" Dia x 3-3/4"H	6 Oz	Case	24-Pcs
E	WDP003-205 Angled Cup	5" Dia x 5"H	8 Oz	Case	24-Pcs



## LAURETS™ *The Rounded Square*

Bright White Porcelain

ITEM	DESCRIPTION	SIZE	CAPACITY	UOM	QTY/CASE
F	WDP008-101 Square Bowl	4-1/2" Sq	9 Oz	Case	24-Pcs
G	WDP008-102 Square Bowl	6-1/4" Sq	20 Oz	Case	24-Pcs
H	WDP008-103 Square Bowl	6-3/4" Sq	1 Qt	Case	24-Pcs
I	WDP008-104 Square Bowl	7-5/8" Sq	1.5 Qt	Case	12-Pcs



## SEFTON™ *Rimless Square*

Bright White Porcelain

ITEM	DESCRIPTION	SIZE	CAPACITY	UOM	QTY/CASE
J	WDP019-101 Square Dish	10" Sq	1.5 Qt	Case	12-Pcs





# CALACATTA™ *Rustic Completion*

Creamy White Porcelain with Marble Effect

ITEM	DESCRIPTION	SIZE	UOM	QTY/PACK
K	WDP001-201	Rectangular Platter 10" x 4-3/4"	Pack	4-Pcs
L	WDP001-202	Rectangular Platter 12" x 5-1/2"	Pack	2-Pcs
M	WDP001-203	Rectangular Platter 13-7/8" x 6"	Pack	2-Pcs
N	WDP001-204	Rectangular Platter 16-1/2" x 7"	Pack	2-Pcs
O	WDP001-205	Square Platter 6-7/8" Sq	Pack	4-Pcs
P	WDP001-206	Square Platter 8-1/2" Sq	Pack	4-Pcs
Q	WDP001-207	Square Platter 10-1/4" Sq	Pack	3-Pcs
R	WDP001-208	Square Platter 11-7/8" Sq	Pack	2-Pcs
S	WDP001-209	Square Platter 14-1/8" Sq	Pack	2-Pcs



# DALMATIA™ *From the Harvest*

Creamy White Porcelain with Wood Grain Effect

ITEM	DESCRIPTION	SIZE	UOM	QTY/PACK
T	WDP002-201	Rectangular Platter 12" x 7"	Pack	2-Pcs
U	WDP002-202	Rectangular Platter 14" x 8-1/8"	Pack	2-Pcs
V	WDP002-203	Rectangular Platter 15-3/4" x 9-1/8"	Pack	2-Pcs
W	WDP002-204	Rectangular Platter 15-1/8" x 10-5/8"	Pack	2-Pcs
X	WDP002-205	Square Platter 10-1/4" Sq	Pack	3-Pcs
Y	WDP002-206	Square Platter 12" Sq	Pack	2-Pcs
Z	WDP002-207	Square Platter 14" Sq	Pack	2-Pcs



# VISCA™ *Classic with a Twist of Nature*

Black & White Dual Textured Porcelain

ITEM	DESCRIPTION	SIZE	UOM	QTY/PACK
AA	WDP023-201	Rectangular Platter 11-5/8" x 7-1/4"	Pack	2-Pcs
BB	WDP023-202	Rectangular Platter 13-1/2" x 8-1/2"	Pack	2-Pcs
CC	WDP023-203	Rectangular Platter 15-1/2" x 10"	Pack	2-Pcs
DD	WDP023-204	Square Platter 11" Sq	Pack	2-Pcs
EE	WDP023-205	Square Platter 13" Sq	Pack	2-Pcs



# PAREDES™ *Simple Presentation*

Bright White Porcelain

ITEM	DESCRIPTION	SIZE	UOM	QTY/CASE
A	WDP017-115	Rectangular Platter 12" x 3-3/4"	Case	24-Pcs
B	WDP017-116	Rectangular Platter 14" x 4-1/2"	Case	24-Pcs
C	WDP017-117	Rectangular Platter 16-1/4" x 5"	Case	12-Pcs
D	WDP017-118	Rectangular Platter 17-3/4" x 5-1/2"	Case	12-Pcs
E	WDP017-119	Rectangular Platter 20-1/4" x 6-1/8"	Case	6-Pcs

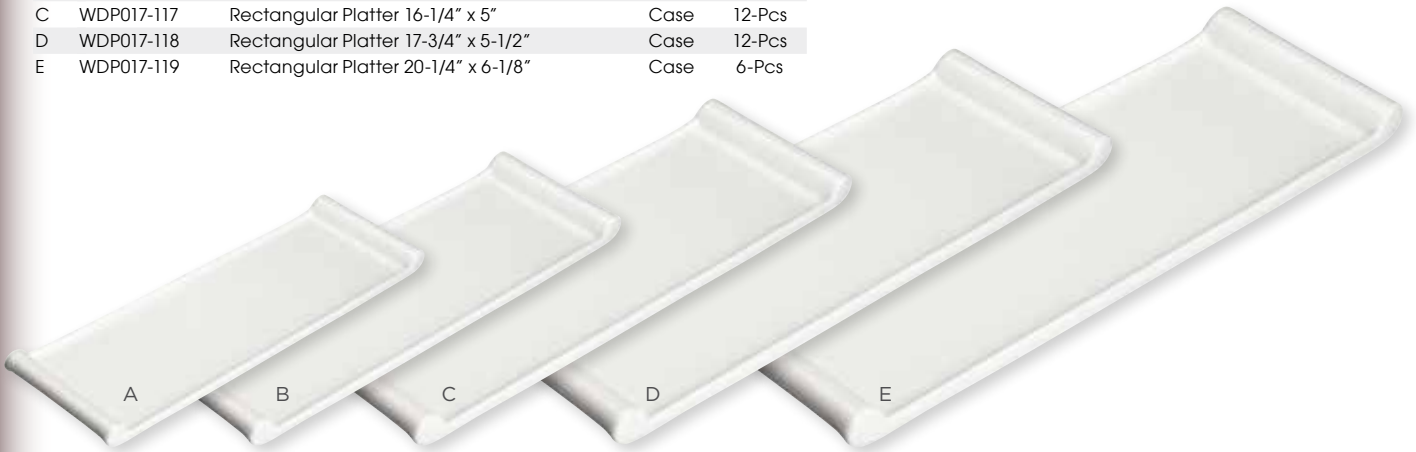

# LOURES™ *To Accessorize*

Bright White Porcelain

ITEM	DESCRIPTION	SIZE	TOTAL CAPACITY	UOM	QTY/CASE
F	WDP017-101	Trio Bowl 14-1/4" x 4"	24 oz	Case	24-Pcs
G	WDP017-102	Trio Bowl 13-1/4" x 5"	50 oz	Case	12-Pcs
H	WDP017-103	Trio Caddy Bowl 7-3/4" x 5"	10 oz	Case	24-Pcs
I	WDP017-104	Trio Bowl 8-3/4" x 3"	5 oz	Case	36-Pcs
J	WDP017-105	Quartet Bowl 11-7/8" x 3"	7.5 oz	Case	36-Pcs
K	WDP017-106	Duo Dish 6"L (2-3/4" Dia Each)	2 oz	Case	36-Pcs
L	WDP017-107	Trio Dish 9-1/2"L (2-3/4" Dia Ea)	3 oz	Case	36-Pcs
M	WDP017-108	Trio Tray 10" x 5"		Case	24-Pcs
N	WDP017-109	Duo Plate 13-7/8" x 8"		Case	12-Pcs
O	WDP017-110	Oblong Plate 15-1/4" x 6-1/2"		Case	12-Pcs



Bright White Porcelain

ITEM	DESCRIPTION	SIZE	UOM	QTY/CASE
P	WDP017-111 Rectangular Platter	10-1/8" x 7"	Case	24-Pcs
Q	WDP017-112 Rectangular Platter	11-7/8" x 8"	Case	12-Pcs
R	WDP017-113 Rectangular Platter	13-7/8" x 9-1/4"	Case	12-Pcs
S	WDP017-114 Rectangular Platter	15-5/8" x 10-5/8"	Case	12-Pcs



**EDESSA™** *Traditional Charm*

Bright White Porcelain

ITEM	DESCRIPTION	SIZE	UOM	QTY/CASE
T	WDP018-101 Square Dish	4-1/4" Sq	Case	36-Pcs
U	WDP018-102 Round Dish	6-5/8" Dia	Case	36-Pcs
V	WDP018-103 Round Dish	8-3/4" Dia	Case	24-Pcs
W	WDP018-104 Round Dish	11" Dia	Case	12-Pcs



**LERA™** *Engaging Curves*

Bright White Porcelain

ITEM	DESCRIPTION	SIZE	UOM	QTY/CASE
X	WDP013-101 Square Bowl, Deep	8-1/4" Sq	Case	12-Pcs
Y	WDP013-102 Square Dish	4-1/4" Sq	Case	36-Pcs
Z	WDP013-103 Square Dish	5-1/4" Sq	Case	36-Pcs
AA	WDP013-104 Square Dish	6" Sq	Case	36-Pcs



**KESTER™** *The Casual Frame*

Bright White Porcelain

ITEM	DESCRIPTION	SIZE	UOM	QTY/CASE
BB	WDP020-101 Square Bowl	5-1/2" Sq	Case	36-Pcs





Mix and Match

# MESCALORE™

Bright White Porcelain

ITEM	DESCRIPTION	SIZE	CAPACITY	UOM	QTY/CASE
A	Handle Dish, Mini	2-1/2" Dia	1.1 Oz	Case	36-Pcs
B	Triangle Bowl	3-7/8"	3 Oz	Case	36-Pcs
C	Teardrop Dish	3-3/4" Dia	3 Oz	Case	36-Pcs
D	Square Bowl, Mini	2-1/2"	1.5 Oz	Case	36-Pcs
E	Square Bowl, Small	3-1/8"	3 Oz	Case	36-Pcs
F	Rectangle Dish, Mini	4-1/2" x 2-7/8"	3 Oz	Case	36-Pcs
G	Rectangle Dish, Sml	5-1/4" x 3-7/8"	4 Oz	Case	36-Pcs
H	Angled Oval Dish	4" x 2-1/2"	3 Oz	Case	36-Pcs
I	Trio Tray	13-3/4" x 5"		Case	24-Pcs
J	Sauce Boat, Mini	3" Dia x 2"H	3 Oz	Case	36-Pcs
K	Long Plate, Mini	5-1/2" x 2-1/2"		Case	36-Pcs
L	Long Plate, Small	8-1/8" x 3-1/8"		Case	36-Pcs
M	Long Plate, Med	9-3/8" x 3-1/2"		Case	36-Pcs
N	Long Plate, Large	10-3/8" x 4"		Case	36-Pcs



# TENORA™ The Stylist Café

Bright White Porcelain

ITEM	DESCRIPTION	SIZE	UOM	QTY/CASE
O	Tray	8" x 3-3/4"	Case	36-Pcs
P	Tray	10-1/2" x 5"	Case	24-Pcs



A Memorable Finish

**NEWRY™**

Bright White Porcelain

ARDESIA™ PORCELAIN

ITEM	DESCRIPTION	SIZE	EACH CAPACITY	UOM	QTY/CASE
Q	Trio Tapas Set	12" x 3-1/2"	5 Oz	Case	12-Sets
R	Quartet Tapas Set	9-3/4" x 6-3/4"	5 Oz	Case	12-Sets
S	Soup/Sandwich Set	11-5/8" x 4-3/4"	9 Oz	Case	12-Sets
T	Trio Bowl Set w/ Wooden Plate	9-3/8" x 4"	3 Oz	Case	24-Sets
U	Trio Bowl Set w/ Wooden Plate	11-5/8" x 3-1/8"	2 Oz	Case	24-Sets
V	Trio Bowl Set w/ Wooden Plate	15-1/4" x 4-1/8"	4.5 Oz	Case	12-Sets
W	Trio Set w/Stand	15" x 3-3/4"	8 Oz	Case	12-Sets
X	Trio Set w/Stand	16-1/2" x 4-5/8"	9 Oz	Case	12-Sets



Q



R



S



T



U



V



W



X

**MELAMINE**

The Ardesia™ by Winco® **melamine** collections bring a level of elegance, as well as strength and durability to your table settings. Melamine is virtually break-resistant, making it an ideal alternative to ceramics and the designated choice for high-volume, everyday use. Available in a variety of colors and textures, shapes and sizes, Ardesia™ by Winco® has the look of ceramics with the solidity of melamine, and a style to fit any environment. **Dishwasher Safe.**

A Touch of Earth Tone

**AVA™**  
Melamine

ITEM	DESCRIPTION	SIZE	CAPACITY	UOM	QTY/CASE
WDM020-401	Round Plate	9" Dia		Case	24-Pcs
WDM020-402	Round Plate	11" Dia		Case	24-Pcs
WDM020-403	Rimless Bowl	6-1/8" Dia	16 Oz	Case	24-Pcs



WDM020-401



WDM020-402



WDM020-403

ITEM	DESCRIPTION	COLOR	SIZE	CAPACITY	UOM	QTY/CASE
WDM001-401	Hammered Plate	Blue	9" Dia		Case	24-Pcs
WDM001-501	Hammered Plate	Red	9" Dia		Case	24-Pcs
WDM001-601	Hammered Plate	Yellow	9" Dia		Case	24-Pcs
WDM001-402	Hammered Plate	Blue	11" Dia		Case	24-Pcs
WDM001-502	Hammered Plate	Red	11" Dia		Case	24-Pcs
WDM001-602	Hammered Plate	Yellow	11" Dia		Case	24-Pcs
WDM001-405	Hammered Plate	Blue	9-5/8" Dia		Case	24-Pcs
WDM001-505	Hammered Plate	Red	9-5/8" Dia		Case	24-Pcs
WDM001-605	Hammered Plate	Yellow	9-5/8" Dia		Case	24-Pcs
WDM001-406	Hammered Bowl	Blue	7-1/2" Dia	0.8 Qt	Case	24-Pcs
WDM001-506	Hammered Bowl	Red	7-1/2" Dia	0.8 Qt	Case	24-Pcs
WDM001-606	Hammered Bowl	Yellow	7-1/2" Dia	0.8 Qt	Case	24-Pcs
WDM001-407	Hammered Bowl	Blue	13-3/4" Dia	3 Qt	Case	12-Pcs
WDM001-507	Hammered Bowl	Red	13-3/4" Dia	3 Qt	Case	12-Pcs
WDM001-607	Hammered Bowl	Yellow	13-3/4" Dia	3 Qt	Case	12-Pcs
WDM001-408	Rectangular Plate	Blue	19" x 8"	0.8 Qt	Case	24-Pcs
WDM001-508	Rectangular Plate	Red	19" x 8"	0.8 Qt	Case	24-Pcs
WDM001-608	Rectangular Plate	Yellow	19" x 8"	0.8 Qt	Case	24-Pcs



WDM001-406  
WDM001-506  
WDM001-606

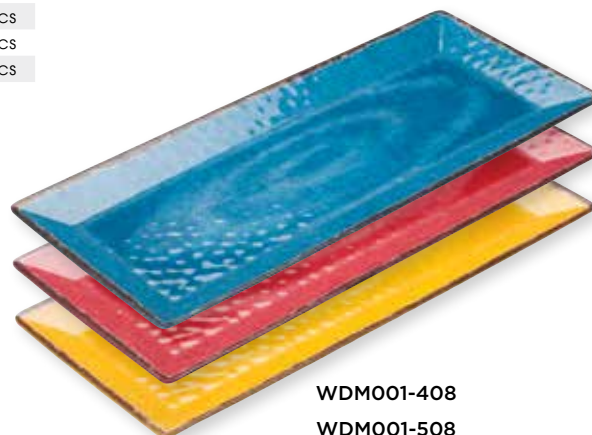

WDM001-408  
WDM001-508  
WDM001-608



WDM001-407  
WDM001-507  
WDM001-607



WDM001-401  
WDM001-501  
WDM001-601



WDM001-402  
WDM001-502  
WDM001-602



WDM001-405  
WDM001-505  
WDM001-605



Versatile Colors  
**LUZIA™**  
Melamine

The Salsa Bowl

**MILA™**  
Melamine



ITEM	DESCRIPTION	COLOR	CAPACITY	UOM	QTY/CASE
WDM008-401	Salsa Bowl	Blue	4 Oz	Case	48-Pcs
WDM008-402	Salsa Bowl	Blue	5 Oz	Case	48-Pcs
WDM008-501	Salsa Bowl	Brown	4 Oz	Case	48-Pcs
WDM008-502	Salsa Bowl	Brown	5 Oz	Case	48-Pcs



WDM008-401



WDM008-501



WDM008-402



WDM008-502



For the Dipper

**HARUKI™**  
Melamine

ITEM	DESCRIPTION	SIZE	CAPACITY	UOM	QTY/CASE
WDM017-301	Square Bowl	2-5/8"	2 Oz	Case	48-Pcs
WDM017-302	Round Bowl	4" Dia	4.5 Oz	Case	48-Pcs



WDM017-301 2-5/8"



WDM017-302 4"DIA





ITEM	DESCRIPTION	SIZE	UOM	QTY/CASE
WDM011-301	Rectangular Plate	8-1/2" x 4-1/2"	Case	24-Pcs
WDM011-302	Rectangular Plate	10-1/2" x 5-1/4"	Case	24-Pcs



WDM011-301



WDM011-302



*The Tides*  
**MIYU™**  
Melamine

ITEM	DESCRIPTION	SIZE	UOM	QTY/CASE
WDM016-301	Rectangular Plate	11-3/8" x 5-1/2"	Case	24-Pcs
WDM016-302	Rectangular Plate	10-1/2" x 4-1/2"	Case	24-Pcs



WDM016-302



WDM016-301



*The Irregular*  
**KONNO™**  
Melamine

ITEM	DESCRIPTION	SIZE	UOM	QTY/CASE
WDM015-301	Triangular Plate	8-1/8"	Case	24-Pcs
WDM015-302	Triangular Plate	9"	Case	24-Pcs



WDM015-301



WDM015-302



*The Matte Trinity*  
**NATSUKI™**  
Melamine



Organically Crafted  
**KAORI™**  
Melamine

ITEM	DESCRIPTION	SIZE	CAPACITY	UOM	QTY/CASE
WDM019-301	Round Platter	11-1/2" Dia		Case	12-Pcs
WDM019-302	Rectangular Platter	12-1/2" x 5"		Case	24-Pcs
WDM019-303	Rectangular Platter	14-1/2" x 6-3/8"		Case	12-Pcs
WDM019-304	Oval Bowl	8-3/4" x 5-3/4"	8 Oz	Case	24-Pcs
WDM019-305	Rectangular Platter	11-1/2" x 9-1/2"		Case	12-Pcs
WDM019-306	Oval Bowl	9" x 6-5/8"	20 Oz	Case	24-Pcs
WDM019-307	Oval Bowl	10" x 6-1/4"	16 Oz	Case	24-Pcs
WDM019-308	Angled Bowl	9" Dia	23 Oz	Case	12-Pcs
WDM019-309	Angled Bowl	11" Dia	1 Qt	Case	12-Pcs



WDM019-302

WDM019-303



WDM019-304

WDM019-306

WDM019-308

WDM019-309

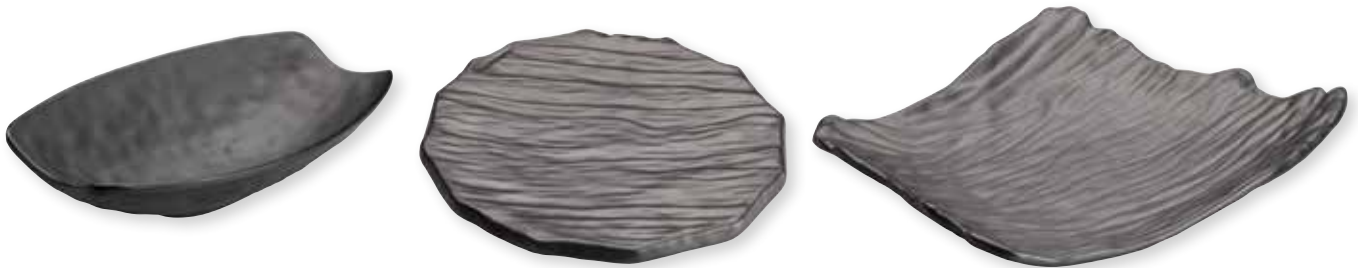

WDM019-307

WDM019-301

WDM019-305



The Fluidity  
**HIROTO™**  
Melamine

ITEM	DESCRIPTION	SIZE	UOM	QTY/CASE
WDM018-301	Rectangular Plate	7-3/4" x 5"	Case	24-Pcs
WDM018-302	Rectangular Plate	8-3/4" x 5-1/2"	Case	24-Pcs
WDM018-303	Rectangular Plate	10" x 6-1/8"	Case	24-Pcs



WDM018-301

WDM018-302



WDM018-303





ITEM	DESCRIPTION	SIZE	CAPACITY	UOM	QTY/CASE
WDM012-301	Bowl	8" Dia	1 Qt	Case	24-Pcs
WDM012-302	Bowl	9" Dia	1.25 Qt	Case	24-Pcs
WDM012-303	Bowl	10" Dia	1.75 Qt	Case	24-Pcs
WDM012-304	Bowl	11-1/2" Dia	2.75 Qt	Case	12-Pcs
WDM012-305	Bowl	13-1/2" Dia	3.75 Qt	Case	6-Pcs



WDM012-301



WDM012-302



WDM012-303



WDM012-304



WDM012-305



Double Texture  
**KUMATA™**  
Melamine

ITEM	DESCRIPTION	SIZE	CAPACITY	UOM	QTY/CASE
WDM014-301	Bowl	5-3/8" Dia	10 Oz	Case	24-Pcs
WDM014-302	Bowl	6-7/8" Dia	22 Oz	Case	24-Pcs
WDM014-303	Bowl	8" Dia	1 Qt	Case	24-Pcs
WDM014-304	Bowl	9" Dia	1.5 Qt	Case	24-Pcs



WDM014-301



WDM014-302



WDM014-303



WDM014-304



The Stacked Coils  
**TOGASHI™**  
Melamine

The Concentric Rings

**RIKA™**  
Melamine

ITEM	DESCRIPTION	SIZE	UOM	QTY/CASE
WDM013-301	Square Plate	8-3/4"	Case	24-Pcs
WDM013-302	Square Plate	9-3/4"	Case	24-Pcs
WDM013-303	Square Plate	10-3/4"	Case	24-Pcs
WDM013-304	Square Plate	11-3/4"	Case	24-Pcs
WDM013-305	Square Plate	12-3/4"	Case	12-Pcs
WDM013-306	Square Plate	13-3/4"	Case	12-Pcs



WDM013-301

WDM013-302

WDM013-303



WDM013-304

WDM013-305

WDM013-306

ITEM	DESCRIPTION	COLOR	SIZE	CAPACITY	UOM	QTY/CASE
WDM009-201	Square Bowl	White	2-1/2"	2 Oz	Case	48-Pcs
WDM009-202	Square Bowl	White	3-1/2"	5 Oz	Case	48-Pcs
WDM009-203	Square Bowl	White	5"	17 Oz	Case	24-Pcs
WDM009-204	Square Bowl	White	7-1/2"	1.75 Qt	Case	12-Pcs
WDM009-205	Square Bowl	White	10"	5 Qt	Case	6-Pcs
WDM009-301	Square Bowl	Black	2-1/2"	2 Oz	Case	48-Pcs
WDM009-302	Square Bowl	Black	3-1/2"	5 Oz	Case	48-Pcs
WDM009-303	Square Bowl	Black	5"	17 Oz	Case	24-Pcs
WDM009-304	Square Bowl	Black	7-1/2"	1.75 Qt	Case	12-Pcs
WDM009-305	Square Bowl	Black	10"	5 Qt	Case	6-Pcs

The Simplicity Element

**LINZA™**  
Melamine



WDM009-201  
WDM009-301

WDM009-202  
WDM009-302

WDM009-203  
WDM009-303



WDM009-204  
WDM009-304

WDM009-205  
WDM009-305

ITEM	DESCRIPTION	SIZE	CAPACITY	UOM	QTY/CASE
WDM005-201	Triangular Bowl	7"	0.75 Qt	Case	24-Pcs
WDM005-202	Triangular Bowl	8"	1 Qt	Case	24-Pcs
WDM005-203	Triangular Bowl	9"	1.25 Qt	Case	24-Pcs
WDM005-204	Triangular Bowl	10"	1.6 Qt	Case	24-Pcs
WDM005-205	Triangular Bowl	11"	2.25 Qt	Case	12-Pcs



WDM005-201

WDM005-202

WDM005-203



WDM005-204

WDM005-205

ITEM	DESCRIPTION	SIZE	CAPACITY	UOM	QTY/CASE
WDM003-201	Angled Bowl	12" Dia	1.75 Qt	Case	12-Pcs
WDM003-202	Angled Bowl	14" Dia	2.75 Qt	Case	12-Pcs
WDM003-203	Angled Bowl	16" Dia	4.5 Qt	Case	6-Pcs



WDM003-201

WDM003-202



WDM003-203



The Triad  
**ELISTA™**  
Melamine

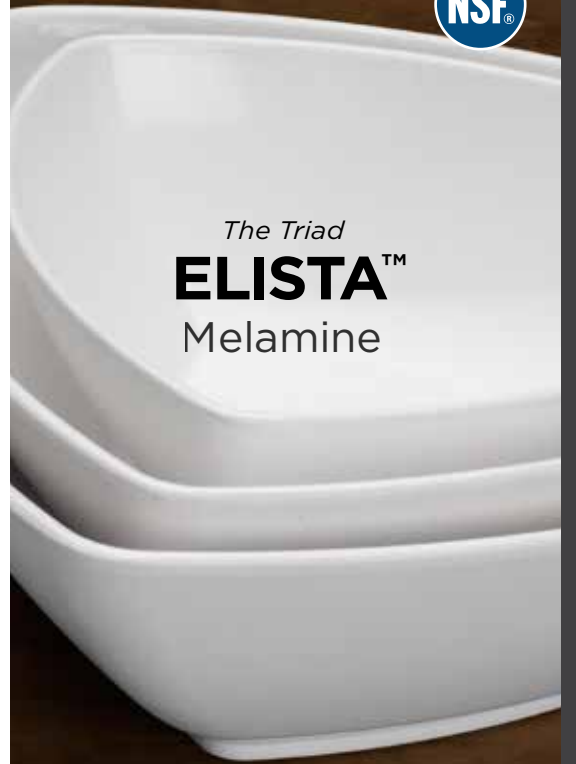

The Modern Slant  
**HAILEY™**  
Melamine





The Embossed Spiral  
**SELENA™**  
 Melamine

ITEM	DESCRIPTION	SIZE	UOM	QTY/CASE
WDM007-201	Triangular Plate	9"	Case	24-Pcs
WDM007-202	Triangular Plate	11"	Case	24-Pcs
WDM007-203	Triangular Plate	13-1/4"	Case	12-Pcs
WDM007-204	Triangular Plate	15-1/4"	Case	12-Pcs



WDM007-201



WDM007-202



WDM007-203



WDM007-204



The Deep Trumpet  
**PRISCILA™**  
 Melamine

ITEM	DESCRIPTION	SIZE	CAPACITY	UOM	QTY/CASE
WDM004-201	Angled Bowl	6-1/2" Dia	0.5 Qt	Case	24-Pcs
WDM004-202	Angled Bowl	7-1/4" Dia	0.75 Qt	Case	24-Pcs
WDM004-203	Angled Bowl	8-1/2" Dia	1 Qt	Case	24-Pcs



WDM004-201



WDM004-202



WDM004-203

ITEM	DESCRIPTION	SIZE	UOM	QTY/CASE
WDM002-401	Rectangular Platter	20-7/8" x 8"	Case	12-Pcs
WDM002-402	Round Platter	11-7/8" Dia	Case	12-Pcs



ITEM	DESCRIPTION	SIZE	CAPACITY	UOM	QTY/CASE
WDM006-201	Trio Plate	16-3/8" x 5-1/2"		Case	24-Pcs
WDM006-202	Trio Bowl	7" Dia	0.5 Qt	Case	24-Pcs



ITEM	DESCRIPTION	SIZE	CAPACITY	UOM	QTY/CASE
WDM010-301	Mini Pan	6-1/4" Dia	13 Oz	Case	24-Pcs



**SLATE** *The Ardesia™ by Winco® slate collection brings a level of elegance to your table settings and inspires creative plating. Hand wash.*

ITEM	DESCRIPTION	SIZE	UOM	QTY/PACK
WDL001-301	Rectangular Platter 11-1/2" x 4"		Pack	6-Pcs
WDL001-302	Rectangular Platter 11-1/2" x 7-7/8"		Pack	6-Pcs
WDL001-303	Rectangular Platter 15-3/4" x 11-1/2"		Pack	6-Pcs

*Straight from the Slate*  
**TAVO™**  
Slate 



WDL001-301



WDL001-302



WDL001-303



# CLASSIC MELAMINE Heat resistant up to 212°F (100°C)



DISHWASHER SAFE

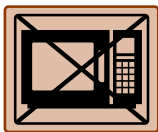

NOT FOR OVEN OR MICROWAVE USE



MMPR-10



MMPR-10W



MMPC



MMPO-118W



MMPT-96



MMPT-96W



MMB-22



MMB-22W



MMB-15



MMB-15W



MMB-12



MMB-12W



## ROUND PLATES

ITEM	SIZE	COLOR	UOM	CASE
MMPR-5	5-1/2" Dia	Tan	Doz	1/8
MMPR-5W	5-1/2" Dia	White	Doz	1/8
MMPR-6	6-3/8" Dia	Tan	Doz	1/4
MMPR-6W	6-3/8" Dia	White	Doz	1/4
MMPR-7	7-1/4" Dia	Tan	Doz	1/8
MMPR-7W	7-1/4" Dia	White	Doz	1/8
MMPR-8	7-7/8" Dia	Tan	Doz	1/4
MMPR-8W	7-7/8" Dia	White	Doz	1/4
MMPR-9	9" Dia	Tan	Doz	1/4
MMPR-9W	9" Dia	White	Doz	1/4
MMPR-10	10" Dia	Tan	Doz	1/2
MMPR-10W	10" Dia	White	Doz	1/2



## OVAL PLATTERS WITH NARROW RIM

ITEM	SIZE	COLOR	UOM	CASE
MMPO-96	9-3/4"L x 6-3/4"W	Tan	Doz	1/2
MMPO-96W	9-3/4"L x 6-3/4"W	White	Doz	1/2
MMPO-118	11-1/2"L x 8"W	Tan	Doz	1/2
MMPO-118W	11-1/2"L x 8"W	White	Doz	1/2
MMPO-138	13"L x 8-1/2"W	Tan	Doz	1/2
MMPO-138W	13"L x 8-1/2"W	White	Doz	1/2
MMPO-139	13-1/8"L x 9-1/2"W	Tan	Doz	1/4
MMPO-139W	13-1/8"L x 9-1/2"W	White	Doz	1/4
MMPO-1510	15-1/2"L x 10-7/8"W	Tan	Doz	1/2
MMPO-1510W	15-1/2"L x 10-7/8"W	White	Doz	1/2



## RECTANGULAR PLATTERS

ITEM	SIZE	COLOR	UOM	CASE
MMPT-96	9-1/2"L x 6-3/4"W	Tan	Doz	1/4
MMPT-96W	9-1/2"L x 6-3/4"W	White	Doz	1/4
MMPT-117	11-1/2"L x 7-1/2"W	Tan	Doz	1/4
MMPT-129	12-1/2"L x 9"W	Tan	Doz	1/2
MMPT-1510	15"L x 10-5/8"W	Tan	Doz	1/2
MMPT-1510W	15"L x 10-5/8"W	White	Doz	1/2



## RIMLESS BOWLS

ITEM	SIZE	CAPACITY	COLOR	UOM	CASE
MMB-22	6-7/8" Dia	22 oz	Tan	Doz	1/2
MMB-22W	6-7/8" Dia	22 oz	White	Doz	1/2
MMB-32	7-3/8" Dia	32 oz	Tan	Doz	1/4
MMB-32W	7-3/8" Dia	32 oz	White	Doz	1/4
MMB-41	8" Dia	41 oz	Tan	Doz	1/4
MMB-41W	8" Dia	41 oz	White	Doz	1/4
MMB-52	8-1/2" Dia	52 oz	Tan	Doz	1/4
MMB-52W	8-1/2" Dia	52 oz	White	Doz	1/4
MMB-96	11" Dia	96 oz	Tan	Doz	1/2



## NAPPIES

ITEM	SIZE	CAPACITY	COLOR	UOM	CASE
MMB-11	4-3/4" Dia	11 oz	Tan	Doz	1/8
MMB-11W	4-3/4" Dia	11 oz	White	Doz	1/8
MMB-15	5-1/8" Dia	15 oz	Tan	Doz	1/8
MMB-15W	5-1/8" Dia	15 oz	White	Doz	1/8



## SOUP/CEREAL BOWLS

ITEM	SIZE	CAPACITY	COLOR	UOM	CASE
MMB-12	6-3/8" Dia	12 oz	Tan	Doz	1/8
MMB-12W	6-3/8" Dia	12 oz	White	Doz	1/8



MELAMINE COLLECTION





**SAUCE CUPS/RAMEKINS**

ITEM	SIZE	CAPACITY	COLOR	UOM	CASE
MMSC-2	2-3/4" Dia	2-1/2 oz	Tan	Doz	1/24
MMSC-2W	2-3/4" Dia	2-1/2 oz	White	Doz	1/24
MMSC-4	3-1/4" Dia	4 oz	Tan	Doz	1/12
MMSC-4W	3-1/4" Dia	4 oz	White	Doz	1/12



**BOUILLON CUPS**

ITEM	SIZE	CAPACITY	COLOR	UOM	CASE
MMB-8	3-7/8" Dia	8 oz	Tan	Doz	1/4
MMB-8W	3-7/8" Dia	8 oz	White	Doz	1/4



**FRUIT BOWLS**

ITEM	SIZE	CAPACITY	COLOR	UOM	CASE
MMB-4	4-5/8" Dia	4 oz	Tan	Doz	1/8
MMB-4W	4-5/8" Dia	4 oz	White	Doz	1/8
MMB-5	4-3/4" Dia	5 oz	Tan	Doz	1/4
MMB-5W	4-3/4" Dia	5 oz	White	Doz	1/4



**GRAPEFRUIT BOWLS**

ITEM	SIZE	CAPACITY	COLOR	UOM	CASE
MMB-10	5-1/2" Dia	10 oz	Tan	Doz	1/8
MMB-10W	5-1/2" Dia	10 oz	White	Doz	1/8
MMB-13	5-5/8" Dia	13 oz	Tan	Doz	1/4
MMB-13W	5-5/8" Dia	13 oz	White	Doz	1/4



**BULBOUS MUGS**

◆ 3-1/2"L x 2-15/16"W/Dia x 3-5/8"H

ITEM	SIZE	CAPACITY	COLOR	UOM	CASE
MMU-8	2-15/16" Dia	8oz	Tan	Doz	1/4
MMU-8W	2-15/16" Dia	8oz	White	Doz	1/4



**RAMEKIN CUPS**

◆ Available fluted or plain; black, bone & white colors

ITEM	DESCRIPTION	SIZE	COLOR	UOM	CASE
RFM-1K	Fluted	1-1/2 Oz	Black	Doz	1/8
RFM-1W	Fluted	1-1/2 Oz	White	Doz	1/8
RFM-1B	Fluted	1-1/2 Oz	Bone	Doz	1/8
RFM-2K	Fluted	2 Oz	Black	Doz	1/8
RFM-2W	Fluted	2 Oz	White	Doz	1/8
RFM-2B	Fluted	2 Oz	Bone	Doz	1/8
RFM-3K	Fluted	3 Oz	Black	Doz	1/8
RFM-3W	Fluted	3 Oz	White	Doz	1/8
RFM-3B	Fluted	3 Oz	Bone	Doz	1/8
RFM-4K	Fluted	4 Oz	Black	Doz	1/8
RFM-4W	Fluted	4 Oz	White	Doz	1/8
RFM-4B	Fluted	4 Oz	Bone	Doz	1/8
RP-1K	Plain	1-1/2 Oz	Black	Doz	1/8
RP-1W	Plain	1-1/2 Oz	White	Doz	1/8
RP-1B	Plain	1-1/2 Oz	Bone	Doz	1/8
RP-2K	Plain	2 Oz	Black	Doz	1/8
RP-2W	Plain	2 Oz	White	Doz	1/8
RP-2B	Plain	2 Oz	Bone	Doz	1/8
RP-3K	Plain	3 Oz	Black	Doz	1/8
RP-3W	Plain	3 Oz	White	Doz	1/8
RP-3B	Plain	3 Oz	Bone	Doz	1/8
RP-4K	Plain	4 Oz	Black	Doz	1/8
RP-4W	Plain	4 Oz	White	Doz	1/8
RP-4B	Plain	4 Oz	Bone	Doz	1/8
RP-6K	Plain	6 Oz	Black	Doz	1/8
RP-6W	Plain	6 Oz	White	Doz	1/8
RP-6B	Plain	6 Oz	Bone	Doz	1/8



# Monte Carlo™



Sleek and sophisticated, the Monte Carlo™ holloware line features clean and fluid contours in brilliant 18/10 stainless steel mirror finish that is striking in all cosmopolitan dining environments.

ITEM	DESCRIPTION	UOM	CASE
Z-MC-C05	Monte Carlo Creamer, 5 oz, 0.2 lbs	Each	6/72
Z-MC-TP10	Monte Carlo Tea Pot, 10 oz, 0.4 lbs	Each	6/72
Z-MC-CP64	Monte Carlo Coffee Server, 64 oz, 1.2 lbs	Each	6/12
Z-MC-WP64	Monte Carlo Water Pitcher (Ice Guard), 64 oz, 1.6 lbs	Each	6/12

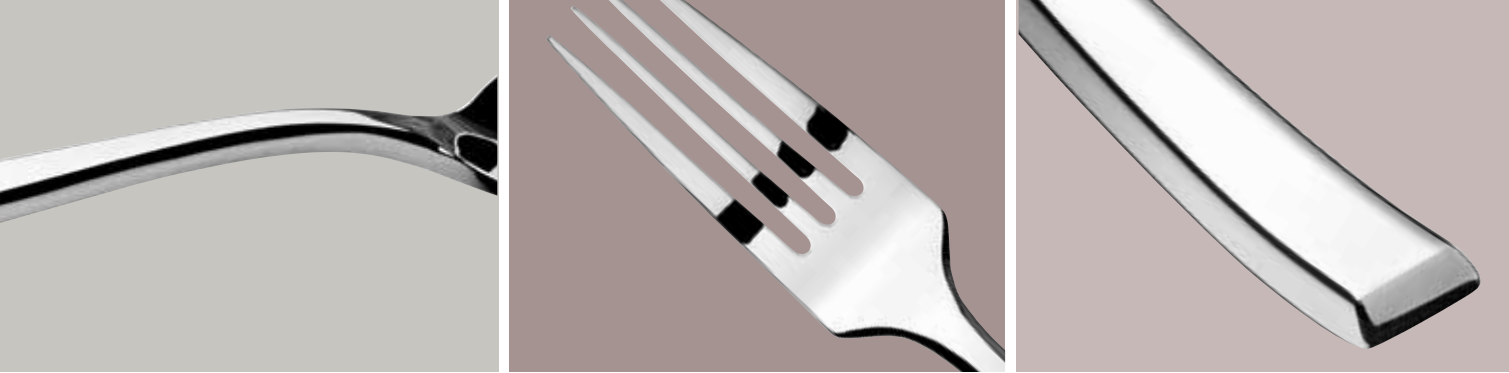

# Isola™

18/10 Stainless Steel



ITEM	DESCRIPTION	UOM	CASE
Z-IS-01	Isola Teaspoon, 6"L, 3.7mm	Doz	1/15
Z-IS-03	Isola Dinner Spoon, 8-3/16"L, 5.0mm	Doz	1/15
Z-IS-04	Isola Boullion Spoon, 7-3/16"L, 5.0mm	Doz	1/15
Z-IS-05	Isola Dinner Fork, 8"L, 5.0mm	Doz	1/15
Z-IS-06	Isola Salad Fork, 7-1/2"L, 4.0mm	Doz	1/15
Z-IS-08	Isola Dinner Knife (Solid), 9-1/2"L, 8.5mm	Doz	1/15

Flawless symmetry of the gardens of Isola Bella inspires the solid, angular design and distinct lines of this pattern, versatile enough to complete a champagne brunch or add polish to upscale bistro settings.

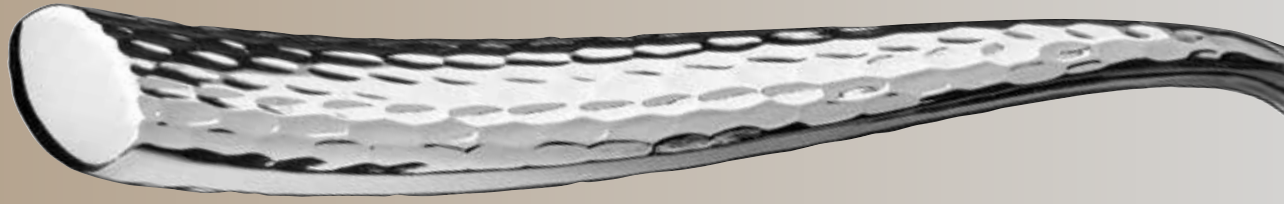

# Ampezzo™

18/10 Stainless Steel



**Luxurious** standout in any setting, the heavyweight and multi-faceted design of this pattern takes inspiration from the mountain range town of Cortina d'Ampezzo.

ITEM	DESCRIPTION	UOM	CASE
Z-AZ-01	Ampezzo Teaspoon, 6"L, 3.0mm	Doz	1/15
Z-AZ-03	Ampezzo Dinner Spoon, 7-11/16"L, 5.2mm	Doz	1/15
Z-AZ-05	Ampezzo Dinner Fork, 8-1/8"L, 4.5mm	Doz	1/15
Z-AZ-06	Ampezzo Salad Fork, 7-1/2"L, 5.2mm	Doz	1/15
Z-AZ-08	Ampezzo Dinner Knife (Solid), 9-1/2"L, 9.0mm	Doz	1/15



# Claret™

18/10 Stainless Steel



ITEM	DESCRIPTION	UOM	CASE
Z-CL-01	Claret Teaspoon, 6"L, 3.5mm	Doz	1/15
Z-CL-03	Claret Dinner Spoon, 7-13/16"L, 4.0mm	Doz	1/15
Z-CL-05	Claret Dinner Fork, 8-1/8"L, 4.0mm	Doz	1/15
Z-CL-06	Claret Salad Fork, 7-11/16"L, 3.5mm	Doz	1/15
Z-CL-08	Claret Dinner Knife (Hollow), 9-7/16"L, 8.5mm	Doz	1/15

Exceptional weight and timeless modernity formed by the smooth contours of the Claret™ pattern sparkle like a tranquil lake, contributing to the perfect setting for any white-linen establishment.

# Carrera™

18/10 Stainless Steel



Inspired by the enduring nature of stone and marble, the unique textured surface of Carrera™ will add a substantial presence to the modern rustic setting of any farm-to-table establishment.

ITEM	DESCRIPTION	UOM	CASE
Z-CR-01	Carrera Teaspoon, 6"L, 3.0mm	Doz	1/15
Z-CR-03	Carrera Dinner Spoon, 7-11/16"L, 3.5mm	Doz	1/15
Z-CR-05	Carrera Dinner Fork, 8-1/4"L, 3.5mm	Doz	1/15
Z-CR-06	Carrera Salad Fork, 7-3/16"L, 3.5mm	Doz	1/15
Z-CR-08	Carrera Dinner Knife (Solid), 9-3/8"L, 8.0mm	Doz	1/15

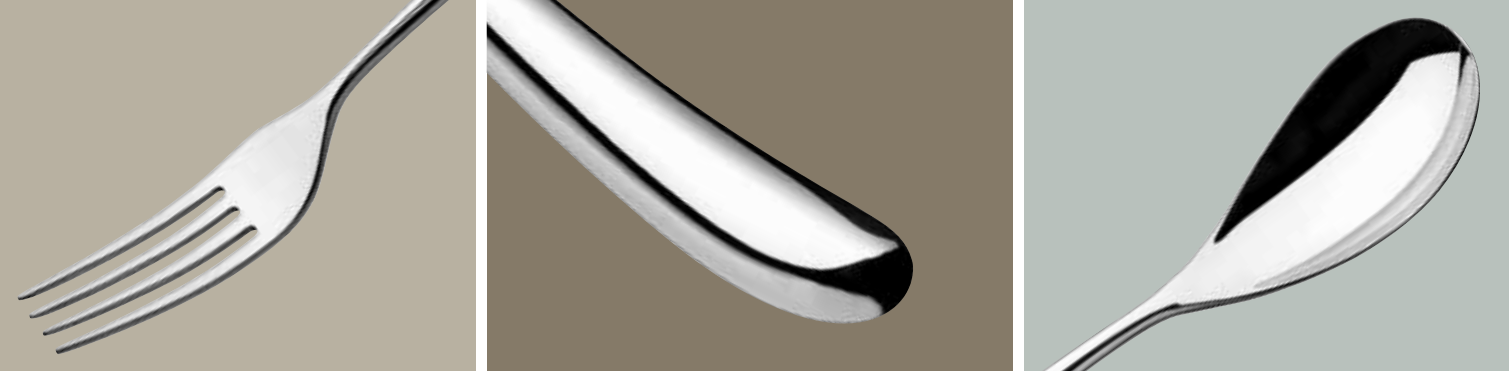

Aires™  
18/10 Stainless Steel



ITEM	DESCRIPTION	UOM	CASE
Z-AR-01	Aires Teaspoon, 6"L, 4.2mm	Doz	1/15
Z-AR-03	Aires Dinner Spoon, 8-1/8"L, 5.2mm	Doz	1/15
Z-AR-05	Aires Dinner Fork, 8-1/8"L, 5.5mm	Doz	1/15
Z-AR-06	Aires Salad Fork, 7"L, 4.5mm	Doz	1/15
Z-AR-08	Aires Dinner Knife (Solid), 9-7/16"L, 9.5mm	Doz	1/15

**Delicate** sculpted lines, teardrop spoon bowls and slender handle proportions that command a maestro's touch, the Aires™ pattern provides an understated flair to any high-concept establishment.

# SHANGARILA



*With simple and elegant contoured lines, the Shangarila pattern brings an understated sophistication to any setting.*

- ◆ 18/8 stainless steel
- ◆ Extra heavyweight
- ◆ Mirror finish
- ◆ 3.0mm thickness  
dinner fork and spoon

ITEM	DESCRIPTION	LENGTH	UOM	CASE
0030-01	Teaspoon	6"	Doz	1/25
0030-02	Iced Tea Spoon	7-3/8"	Doz	1/25
0030-03	Dinner Spoon	7-1/4"	Doz	1/25
0030-04	Bouillon Spoon	5-7/8"	Doz	1/25
0030-05	Dinner Fork	7-1/4"	Doz	1/25
0030-051	Dinner Fork	7-1/2"	Doz	1/25
0030-06	Salad Fork	6-3/4"	Doz	1/25
0030-07	Oyster Fork	5-11/16"	Doz	1/25
0030-08	Dinner Knife	9-1/4"	Doz	1/15
0030-09	Demitasse Spoon	4-5/8"	Doz	1/25
0030-10	Tablespoon (Euro Length)	8-1/4"	Doz	1/25
0030-11	Table Fork (Euro Length)	8"	Doz	1/25
0030-12	Butter Spreader	6-3/4"	Doz	1/25
0030-15	Hollow Handle Table Knife	9-1/4"	Doz	1/15
0030-16	Steak Knife Pointed Tip	8-7/8"	Doz	1/15
0030-18	European Table Knife	9-3/4"	Doz	1/15
0030-19	Salad Knife	8-7/16"	Doz	1/15

Shangarila Serving Pieces



## SHANGARILA SERVING PIECES

ITEM	DESCRIPTION	LENGTH	UOM	CASE
0030-21	Large Bowl Serving Spoon	9"	Doz	1/10
0030-22	Cold Meat Serving Fork	8-1/2"	Doz	1/10
0030-23	Solid Serving Spoon	11-1/2"	Doz	1/10
0030-24	Slotted Serving Spoon	11-1/2"	Doz	1/10
0030-25	Banquet Serving Fork	12"	Doz	1/10



# PEACOCK



*Like its namesake, the sculpted detail of the Peacock pattern blends seamlessly into any elaborate setting.*

- ◆ 18/8 stainless steel
- ◆ Extra heavyweight
- ◆ Mirror finish
- ◆ 3.0mm thickness  
dinner fork and spoon

ITEM	DESCRIPTION	LENGTH	UOM	CASE
0031-01	Teaspoon	6-1/8"	Doz	1/25
0031-02	Iced Tea Spoon	7-13/16"	Doz	1/25
0031-03	Dinner Spoon	7-9/16"	Doz	1/25
0031-04	Bouillon Spoon	6"	Doz	1/25
0031-05	Dinner Fork	7-13/16"	Doz	1/25
0031-06	Salad Fork	6-3/4"	Doz	1/25
0031-07	Oyster Fork	5-3/4"	Doz	1/25
0031-08	Dinner Knife	8-7/8"	Doz	1/15
0031-09	Demitasse Spoon	4-1/2"	Doz	1/25
0031-10	Tablespoon (Euro Length)	8-3/8"	Doz	1/25
0031-11	Table Fork (Euro Length)	8"	Doz	1/25
0031-12	Butter Spreader	6-3/4"	Doz	1/25
0031-18	European Table Knife	9-5/8"	Doz	1/15

# CHANTELLE



*Inspired by the Regency era, the delicate flourished lines of the Chantelle pattern add a traditional touch to any setting.*

- ◆ 18/8 stainless steel
- ◆ Extra heavyweight
- ◆ Mirror finish
- ◆ 3.0mm thickness  
dinner fork and spoon

ITEM	DESCRIPTION	LENGTH	UOM	CASE
0039-01	Teaspoon	6"	Doz	1/25
0039-02	Iced Tea Spoon	7-1/2"	Doz	1/25
0039-03	Dinner Spoon	7-1/4"	Doz	1/25
0039-04	Bouillon Spoon	5-7/8"	Doz	1/25
0039-05	Dinner Fork	7-1/4"	Doz	1/25
0039-06	Salad Fork	6-1/4"	Doz	1/25
0039-07	Oyster Fork	5-5/8"	Doz	1/25
0039-08	Dinner Knife	9-5/16"	Doz	1/15
0039-09	Demitasse Spoon	4-5/8"	Doz	1/25
0039-10	Tablespoon (Euro Length)	8-1/2"	Doz	1/25
0039-11	Table Fork (Euro Length)	8-1/8"	Doz	1/25
0039-12	Butter Spreader	6-3/4"	Doz	1/25

# VENICE



*Inspired by the water of the floating city, the smooth surface of the Venice pattern brings an understated elegance to any contemporary setting.*

- ◆ 18/8 stainless steel
- ◆ Extra heavyweight
- ◆ Mirror finish
- ◆ 3.0mm thickness dinner fork and spoon

ITEM	DESCRIPTION	LENGTH	UOM	CASE
0037-01	Teaspoon	6-1/8"	Doz	1/25
0037-02	Iced Tea Spoon	7-1/4"	Doz	1/25
0037-03	Dinner Spoon	7-3/8"	Doz	1/25
0037-04	Bouillon Spoon	6-1/4"	Doz	1/25
0037-05	Dinner Fork	7-5/8"	Doz	1/25
0037-06	Salad Fork	6-3/4"	Doz	1/25
0037-07	Oyster Fork	5-5/8"	Doz	1/25
0037-08	Dinner Knife	9-1/8"	Doz	1/15
0037-09	Demitasse Spoon	4-1/2"	Doz	1/25
0037-10	Tablespoon (Euro Length)	8-1/4"	Doz	1/25
0037-11	Table Fork (Euro Length)	8-3/8"	Doz	1/25
0037-12	Butter Spreader	6-3/4"	Doz	1/25

# DELUXE PEARL



*Like a strand of pearls, the delicate beading detail of the Deluxe Pearl pattern is a timeless classic that will enhance any setting.*

- ◆ 18/8 stainless steel
- ◆ Extra heavyweight
- ◆ Mirror finish
- ◆ 3.0mm thickness  
dinner fork and spoon

ITEM	DESCRIPTION	LENGTH	UOM	CASE
0036-01	Teaspoon	6"	Doz	1/25
0036-02	Iced Tea Spoon	7-1/8"	Doz	1/25
0036-03	Dinner Spoon	7-1/4"	Doz	1/25
0036-04	Bouillon Spoon	5-7/8"	Doz	1/25
0036-05	Dinner Fork	7-1/4"	Doz	1/25
0036-06	Salad Fork	7"	Doz	1/25
0036-07	Oyster Fork	5-3/8"	Doz	1/25
0036-08	Dinner Knife	9"	Doz	1/15
0036-09	Demitasse Spoon	4-1/4"	Doz	1/25
0036-10	Tablespoon (Euro Length)	8-1/8"	Doz	1/25
0036-11	Table Fork (Euro Length)	8-1/8"	Doz	1/25
0036-12	Butter Spreader	6-3/4"	Doz	1/25
0036-16	Salad Knife	8-3/8"	Doz	1/25

# STANFORD



*With a subtle elevated fold down the center of a teardrop-shaped handle, the Stanford pattern brings an elegant touch to a contemporary setting.*

- ◆ 18/8 stainless steel
- ◆ Extra heavyweight
- ◆ Mirror finish
- ◆ 3.0mm thickness dinner fork and spoon

ITEM	DESCRIPTION	LENGTH	UOM	CASE
0034-01	Teaspoon	6"	Doz	1/25
0034-02	Iced Tea Spoon	7-5/16"	Doz	1/25
0034-03	Dinner Spoon	7-1/8"	Doz	1/25
0034-04	Bouillon Spoon	6-15/16"	Doz	1/25
0034-05	Dinner Fork	7-1/8"	Doz	1/25
0034-051	Dinner Fork, Extended Length	7-1/4"	Doz	1/25
0034-06	Salad Fork	5-7/8"	Doz	1/25
0034-061	Salad Fork, Extended Length	6-7/8"	Doz	1/25
0034-07	Oyster Fork	5-7/16"	Doz	1/25
0034-08	Dinner Knife	9"	Doz	1/15
0034-09	Demitasse Spoon	4-3/8"	Doz	1/25
0034-10	Tablespoon (Euro Length)	8-5/8"	Doz	1/25
0034-11	Table Fork (Euro Length)	8-1/4"	Doz	1/25
0034-12	Butter Spreader	6-5/8"	Doz	1/25
0034-15	Hollow Handle Dinner Knife	8-3/4"	Doz	1/15
0034-18	Hollow Handle Table Knife	9-5/8"	Doz	1/15

# VICTORIA



*The simple aristocratic lines of the Victoria pattern make it an ideal choice for a formal setting.*

- ◆ 18/8 stainless steel
- ◆ Extra heavyweight
- ◆ Mirror finish
- ◆ 3.0mm thickness  
dinner fork and spoon

ITEM	DESCRIPTION	LENGTH	UOM	CASE
0035-01	Teaspoon	6"	Doz	1/25
0035-02	Iced Tea Spoon	7-1/2"	Doz	1/25
0035-03	Dinner Spoon	7-3/8"	Doz	1/25
0035-04	Bouillon Spoon	5-7/8"	Doz	1/25
0035-05	Dinner Fork	7-1/4"	Doz	1/25
0035-06	Salad Fork	6-7/8"	Doz	1/25
0035-07	Oyster Fork	5-9/16"	Doz	1/25
0035-08	Dinner Knife	9-1/4"	Doz	1/15
0035-09	Demitasse Spoon	4-3/8"	Doz	1/25
0035-10	Tablespoon (Euro Length)	8-1/4"	Doz	1/25
0035-11	Table Fork (Euro Length)	8-1/4"	Doz	1/25
0035-12	Butter Spreader	6-3/4"	Doz	1/25
0035-16	Salad Knife	8-1/2"	Doz	1/25

# OXFORD



*The dignified outline on the fiddle-shaped handle of the Oxford pattern lends a touch of old-fashioned elegance to a setting.*

- ◆ 18/8 stainless steel
- ◆ Extra heavyweight
- ◆ Mirror finish
- ◆ 3.0mm thickness dinner fork and spoon

ITEM	DESCRIPTION	LENGTH	UOM	CASE
0033-01	Teaspoon	6-1/4"	Doz	1/25
0033-02	Iced Tea Spoon	7-1/2"	Doz	1/25
0033-03	Dinner Spoon	7-3/8"	Doz	1/25
0033-04	Bouillon Spoon	6"	Doz	1/25
0033-05	Dinner Fork	7-5/8"	Doz	1/25
0033-06	Salad Fork	7"	Doz	1/25
0033-07	Oyster Fork	5-5/8"	Doz	1/25
0033-08	Dinner Knife	9-5/8"	Doz	1/15
0033-09	Demitasse Spoon	4-1/2"	Doz	1/25
0033-10	Tablespoon (Euro Length)	8"	Doz	1/25
0033-11	Table Fork (Euro Length)	8-1/8"	Doz	1/25
0033-12	Butter Spreader	7"	Doz	1/25

## CONTINENTAL



The Continental pattern is the moderately priced version of the Shangarila pattern with the same simple contour lines and features.

- ◆ 18/0 stainless steel
- ◆ Extra heavyweight
- ◆ Mirror finish
- ◆ 3.0mm thickness dinner fork and spoon

ITEM	DESCRIPTION	LENGTH	UOM	CASE
0021-01	Teaspoon	6"	Doz	1/25
0021-02	Iced Tea Spoon	7-1/2"	Doz	1/25
0021-03	Dinner Spoon	7-1/4"	Doz	1/25
0021-04	Bouillon Spoon	5-7/8"	Doz	1/25
0021-05	Dinner Fork	7-1/4"	Doz	1/25
0021-06	Salad Fork	6-3/4"	Doz	1/25
0021-07	Oyster Fork	5-5/8"	Doz	1/25
0030-08	Dinner Knife	9-1/4"	Doz	1/15
0021-09	Demitasse Spoon	4-1/8"	Doz	1/25
0021-10	Tablespoon (Euro Length)	8-1/4"	Doz	1/25
0021-11	Table Fork (Euro Length)	8"	Doz	1/25

## TOULOUSE



The Toulouse pattern features a fiddle shape handle with a stylish shell motif.

- ◆ 18/0 stainless steel
- ◆ Extra heavyweight
- ◆ Mirror finish
- ◆ 3.0mm thickness dinner fork and spoon

ITEM	DESCRIPTION	LENGTH	UOM	CASE
0006-01	Teaspoon	6-3/8"	Doz	1/25
0006-02	Iced Tea Spoon	7"	Doz	1/25
0006-03	Dinner Spoon	7-3/8"	Doz	1/25
0006-04	Bouillon Spoon	6-3/8"	Doz	1/25
0006-05	Dinner Fork	7-5/8"	Doz	1/25
0006-06	Salad Fork	7"	Doz	1/25
0006-07	Oyster Fork	6"	Doz	1/25
0006-08	Dinner Knife	8-3/4"	Doz	1/25
0006-09	Demitasse Spoon	4-5/8"	Doz	1/25
0006-10	Tablespoon	8-1/4"	Doz	1/25
0006-12	Butter Spreader	7-1/16"	Doz	1/25



The Dots pattern features simple lines and elegant beading details around the handle and neck.

- ◆ 18/0 stainless steel
- ◆ Heavyweight
- ◆ Mirror finish

ITEM	DESCRIPTION	LENGTH	UOM	CASE
0005-01	Teaspoon	6-1/4"	Doz	1/50
0005-02	Iced Tea Spoon	7-1/8"	Doz	1/50
0005-03	Dinner Spoon	7-3/8"	Doz	1/50
0005-04	Bouillon Spoon	6-1/8"	Doz	1/50
0005-05	Dinner Fork	7-3/8"	Doz	1/50
0005-06	Salad Fork	6-1/4"	Doz	1/50
0005-07	Oyster Fork	5-5/8"	Doz	1/50
0005-08	Dinner Knife	8-3/4"	Doz	1/25
0005-09	Demitasse Spoon	4-3/4"	Doz	1/50
0005-10	Tablespoon	8-3/8"	Doz	1/25



The Lafayette pattern features a ridged surface with a double scallop accent.

- ◆ 18/0 stainless steel
- ◆ Heavyweight
- ◆ Satin finish

ITEM	DESCRIPTION	LENGTH	UOM	CASE
0015-01	Teaspoon	6"	Doz	1/50
0015-02	Iced Tea Spoon	7-1/4"	Doz	1/50
0015-03	Dinner Spoon	7-1/4"	Doz	1/50
0015-04	Bouillon Spoon	6"	Doz	1/50
0015-05	Dinner Fork	7-5/8"	Doz	1/50
0015-054	Dinner Fork, 4 tines	7-1/2"	Doz	1/50
0015-06	Salad Fork	6-3/4"	Doz	1/50
0015-07	Oyster Fork	5-1/2"	Doz	1/50
0015-08	Dinner Knife	7-3/8"	Doz	1/25
0015-10	Dinner Knife, Hollow Handle	9-1/4"	Doz	1/15
0015-11	Steak Knife, Hollow Handle	9-1/4"	Doz	1/15





The Regency pattern features defined, clean column lines.

- ◆ 18/0 stainless steel
- ◆ Heavyweight
- ◆ Mirror finish

ITEM	DESCRIPTION	LENGTH	UOM	CASE
0007-01	Teaspoon	6"	Doz	1/50
0007-03	Dinner Spoon	7-1/8"	Doz	1/50
0007-04	Bouillon Spoon	5-5/8"	Doz	1/50
0007-05	Dinner Fork	7-3/8"	Doz	1/50
0007-06	Salad Fork	6-1/16"	Doz	1/50
0007-08	Dinner Knife	8-1/2"	Doz	1/25



The Lisa pattern features clean lines and a distinctively raised pitch.

- ◆ 18/0 stainless steel
- ◆ Heavyweight
- ◆ Mirror finish

ITEM	DESCRIPTION	LENGTH	UOM	CASE
0010-01	Teaspoon	6-1/16"	Doz	1/50
0010-03	Dinner Spoon	7-3/4"	Doz	1/50
0010-05	Dinner Fork	7-5/8"	Doz	1/50
0010-08	Dinner Knife	8-1/8"	Doz	1/25

*The Winston pattern features a fiddle shaped handle with a smooth finish.*

- ◆ 18/0 stainless steel
- ◆ Heavyweight
- ◆ Satin finish

ITEM	DESCRIPTION	LENGTH	UOM	CASE
0016-01	Teaspoon	6-1/8"	Doz	1/50
0016-02	Iced Tea Spoon	7-3/4"	Doz	1/50
0016-03	Dinner Spoon	7-3/8"	Doz	1/50
0016-04	Bouillon Spoon	6-1/8"	Doz	1/50
0016-05	Dinner Fork	7-1/4"	Doz	1/50
0016-06	Salad Fork	6-1/2"	Doz	1/50
0016-08	Dinner Knife	8-3/8"	Doz	1/25



*The Manhattan pattern features subtle grooves from the handle neck to the mid-section.*

- ◆ 18/0 stainless steel
- ◆ Heavyweight
- ◆ Satin finish

ITEM	DESCRIPTION	LENGTH	UOM	CASE
0008-01	Teaspoon	6-1/8"	Doz	1/50
0008-03	Dinner Spoon	6-3/4"	Doz	1/50
0008-04	Bouillon Spoon	6"	Doz	1/50
0008-05	Dinner Fork	7-1/4"	Doz	1/50
0008-08	Dinner Knife	8-1/8"	Doz	1/25





ELITE

The Elite pattern features a smooth contoured handle with rounded tip.

- ◆ 18/0 stainless steel
- ◆ Heavyweight
- ◆ Mirror finish

AVAILABLE IN CLEAR PACKS

ITEM	DESCRIPTION	LENGTH	UOM	CASE
0026-01	Teaspoon	6"	Doz	1/50
0026-03	Dinner Spoon	7"	Doz	1/50
0026-04	Bouillon Spoon	5-7/8"	Doz	1/50
0026-05	Dinner Fork	7-1/8"	Doz	1/50
0026-06	Salad Fork	6-1/8"	Doz	1/50
0026-08	Dinner Knife	8-5/8"	Doz	1/25

**NEW**  
SEE PAGE 61 FOR ELITE SOLD IN CLEAR PACKS



FLUTE

The Flute pattern features an elongated oval handle with a smooth finish.

- ◆ 18/0 stainless steel
- ◆ Heavyweight
- ◆ Mirror finish

ITEM	DESCRIPTION	LENGTH	UOM	CASE
0019-01	Teaspoon	5-7/8"	Doz	1/50
0019-03	Dinner Spoon	7-3/16"	Doz	1/50
0019-04	Bouillon Spoon	5-5/8"	Doz	1/50
0019-05	Dinner Fork	7-3/8"	Doz	1/50
0019-06	Salad Fork	6-1/4"	Doz	1/50
0019-08	Dinner Knife	9"	Doz	1/25

The Houston pattern features a fiddle shape handle with a turned out collar at the neck.

- ◆ 18/0 stainless steel
- ◆ Heavyweight
- ◆ Satin finish

ITEM	DESCRIPTION	LENGTH	UOM	CASE
0025-01	Teaspoon	6-1/8"	Doz	1/50
0025-03	Dinner Spoon	7-3/16"	Doz	1/50
0025-04	Bouillon Spoon	6"	Doz	1/50
0025-05	Dinner Fork	7-3/8"	Doz	1/50
0025-06	Salad Fork	6-1/8"	Doz	1/50
0025-08	Dinner Knife	8-3/4"	Doz	1/25



The Elegance pattern in mirror finish features embossed floral embellishments with a single motif at the handle tip.

- ◆ 18/0 stainless steel
- ◆ Heavyweight
- ◆ Mirror finish

ITEM	DESCRIPTION	LENGTH	UOM	CASE
0024-01	Teaspoon	6-1/4"	Doz	1/50
0024-03	Dinner Spoon	7-1/8"	Doz	1/50
0024-04	Bouillon Spoon	6-3/16"	Doz	1/50
0024-05	Dinner Fork	7-3/8"	Doz	1/50



SEE PAGE 79 FOR COORDINATING ELEGANCE SERVING PIECES

The Elegance pattern in vibro finish features embossed floral embellishments with a single motif at the handle tip.

- ◆ 18/0 stainless steel
- ◆ Heavyweight
- ◆ Vibro finish

ITEM	DESCRIPTION	LENGTH	UOM	CASE
0004-01	Teaspoon	6-3/8"	Doz	1/50
0004-02	Iced Tea Spoon	8"	Doz	1/50
0004-03	Dinner Spoon	7-1/4"	Doz	1/50
0004-04	Bouillon Spoon	6"	Doz	1/50
0004-05	Dinner Fork	7-1/4"	Doz	1/50
0004-06	Salad Fork	6-1/2"	Doz	1/50
0004-07	Oyster Fork	6"	Doz	1/50
0004-08	Dinner Knife	8-5/8"	Doz	1/25
0004-09	Demitasse Spoon	4-1/2"	Doz	1/50
0004-10	Tablespoon	8-3/8"	Doz	1/25



DOMINION

AVAILABLE IN CLEAR PACKS



The Dominion pattern features an art deco design with two lines down the length of the handle.

- ◆ 18/0 stainless steel
- ◆ Medium weight
- ◆ Vibro finish

ITEM	DESCRIPTION	LENGTH	UOM	CASE
0001-01	Teaspoon	5-13/16"	Doz	1/50
0001-02	Iced Tea Spoon	7-7/8"	Doz	1/50
0001-03	Dinner Spoon	7"	Doz	1/50
0001-04	Bouillon Spoon	6"	Doz	1/50
0001-05	Dinner Fork	7-1/8"	Doz	1/50
0001-06	Salad Fork	6-1/8"	Doz	1/50
0001-07	Oyster Fork	5-5/8"	Doz	1/50
0001-08	Dinner Knife	8"	Doz	1/25
0001-09	Demitasse Spoon	4-5/8"	Doz	1/50
0001-10	Tablespoon	7-5/8"	Doz	1/25

- ◆ 18/0 stainless steel
- ◆ Heavyweight
- ◆ Vibro finish

ITEM	DESCRIPTION	LENGTH	UOM	CASE
0014-01	Teaspoon	5-3/4"	Doz	1/50
0014-03	Dinner Spoon	7"	Doz	1/50
0014-04	Bouillon Spoon	5-7/8"	Doz	1/50
0014-05	Dinner Fork	7-1/16"	Doz	1/50
0014-06	Salad Fork	6-1/8"	Doz	1/50
0014-08	Dinner Knife, 55g	7-7/8"	Doz	1/25

WINDSOR

AVAILABLE IN CLEAR PACKS



The Windsor pattern is a classic that features a smooth contour design.

- ◆ 18/0 stainless steel
- ◆ Medium weight
- ◆ Vibro finish

ITEM	DESCRIPTION	LENGTH	UOM	CASE
0002-01	Teaspoon	5-7/8"	Doz	1/50
0002-02	Iced Tea Spoon	8"	Doz	1/50
0002-03	Dinner Spoon	7"	Doz	1/50
0002-04	Bouillon Spoon	6"	Doz	1/50
0002-05	Dinner Fork	7"	Doz	1/50
0002-06	Salad Fork	6-1/4"	Doz	1/50
0002-07	Oyster Fork	5-1/2"	Doz	1/50
0002-08	Dinner Knife	8"	Doz	1/25
0002-09	Demitasse Spoon	4-5/8"	Doz	1/50
0002-10	Tablespoon	7-5/8"	Doz	1/25

- ◆ 18/0 stainless steel
- ◆ Heavyweight
- ◆ Vibro finish

ITEM	DESCRIPTION	LENGTH	UOM	CASE
0012-01	Teaspoon	5-15/16"	Doz	1/50
0012-03	Dinner Spoon	7"	Doz	1/50
0012-04	Bouillon Spoon	5-7/8"	Doz	1/50
0012-05	Dinner Fork	7-1/16"	Doz	1/50
0012-06	Salad Fork	6-1/8"	Doz	1/50
0012-08	Dinner Knife, 55g	8"	Doz	1/25

**ELITE IN CLEAR-VIEW PACKS**

- ◆ 18/0 stainless steel
- ◆ Heavyweight
- ◆ Mirror finish

ITEM	DESCRIPTION	LENGTH	UOM	CASE
0083-01	Teaspoon, 2-Doz/Pk	6"	Pack	1/25
0083-05	Dinner Fork, 2-Doz/Pk	7-1/8"	Pack	1/25
0083-08	Dinner Knife, 1-Doz/Pk	8-5/8"	Pack	1/25

**DOMINION IN CLEAR-VIEW PACKS**

- ◆ 18/0 stainless steel
- ◆ Medium weight
- ◆ Vibro finish

ITEM	DESCRIPTION	LENGTH	UOM	CASE
0081-01	Teaspoon, 2-Doz/Pk	5-13/16"	Pack	1/24
0081-02	Iced Tea Spoon, 2-Doz/Pk	7-7/8"	Pack	1/24
0081-03	Dinner Spoon, 2-Doz/Pk	7"	Pack	1/24
0081-04	Bouillon Spoon, 2-Doz/Pk	6"	Pack	1/24
0081-05	Dinner Fork, 2-Doz/Pk	7-1/8"	Pack	1/24
0081-06	Salad Fork, 2-Doz/Pk	6-1/8"	Pack	1/24
0081-07	Oyster Fork, 2-Doz/Pk	5-5/8"	Pack	1/24
0081-08	Dinner Knife, 1-Doz/Pk	8"	Pack	1/24

**WINDSOR IN CLEAR-VIEW PACKS**

- ◆ 18/0 stainless steel
- ◆ Medium weight
- ◆ Vibro finish

ITEM	DESCRIPTION	LENGTH	UOM	CASE
0082-01	Teaspoon, 2-Doz/Pk	5-7/8"	Pack	1/24
0082-02	Iced Tea Spoon, 2-Doz/Pk	8"	Pack	1/24
0082-03	Dinner Spoon, 2-Doz/Pk	7"	Pack	1/24
0082-04	Bouillon Spoon, 2-Doz/Pk	6"	Pack	1/24
0082-05	Dinner Fork, 2-Doz/Pk	7"	Pack	1/24
0082-06	Salad Fork, 2-Doz/Pk	6-1/4"	Pack	1/24
0082-07	Oyster Fork, 2-Doz/Pk	5-1/2"	Pack	1/24
0082-08	Dinner Knife, 1-Doz/Pk	8"	Pack	1/24

**FLATWARE IN CLEAR PACKS**



Complete any table setting with this grapefruit spoon. The serrated edge cuts easily into any citrus fruit.

**GRAPEFRUIT SPOON**

ITEM	DESCRIPTION	LENGTH	UOM	CASE
SRS-6	Grapefruit Spoon, Heavyweight	6-1/4"	Doz	1/25



SRS-6

STEAK KNIVES



4 Piece Boxed Set



ACERO STEAK KNIVES

A Winco® exclusive, these heavyweight knives are a must-have on the tables of any steak house. With its sharp serrated edge and pointed tip, the Acero knife is designed to make simple work of cutting through steaks and chops. A stainless steel end cap provides excellent balance and control.

ITEM	DESCRIPTION	BLADE	UOM	CASE
SK-22	Acero Gourmet Steak Knives, Round Tip	5"	Doz	1/6
SK-12	Acero Gourmet Steak Knives, 12-pc Bulk Pack	5"	Doz	1/6
SK-1	Acero Gourmet Steak Knives, 4-pc Gift Pack	5"	Pack	1/6



NSF SK-1

NSF SK-22

NSF SK-12



NSF K-81P

NSF K-85P

K-70P

K-71P

K-80P

NSF K-60P

NSF K-50P



JUMBO PLASTIC HANDLE STEAK KNIVES

Complete steak house table settings with these attractive and durable steak knives.

◆ NSF listed

ITEM	DESCRIPTION	BLADE	UOM	CASE
K-81P	Round Tip, Solid POM Hdl	4-3/4"	Pack	6/12
K-85P	Round Tip, Plastic Hdl	5"	Doz	1/12



K-81P  
6-piece  
Jumbo  
steak knives  
packaging

SOLID POM HANDLE STEAK KNIVES

ITEM	DESCRIPTION	BLADE	UOM	CASE
K-70P	Pointed Tip, POM Hdl	5"	Doz	1/24
K-71P	Round Tip, POM Hdl	4-1/2"	Doz	1/24
K-80P	Round Tip, POM Hdl	5"	Doz	1/25

PLASTIC HANDLE STEAK KNIVES

◆ NSF listed

ITEM	DESCRIPTION	BLADE	UOM	CASE
K-60P	Pointed Tip	5"	Doz	1/24
K-50P	Round Tip	5"	Doz	1/48



**EURO SLIM STEAK KNIFE**

Attractive and sturdy, the euro slim steak knife offers elegance and function.

◆ 12 pcs packaged in hanging clear-view pack

ITEM	DESCRIPTION	BLADE	UOM	CASE
K-73PC	Pointed Tip, ABS Handle, 3 Rivets	4-1/2"	Doz	1/24

Replaces K-73P

**STEAK KNIVES**



**JUMBO WOODEN HANDLE STEAK KNIVES**

Bring a refined rustic aesthetic to steak house table settings with wooden handle steak knives.

ITEM	DESCRIPTION	BLADE	UOM	CASE
K-82	Pointed Tip, Polywood Handle, 3 Rivets	4-3/4"	Pack	6/12
KB-15W	Round Tip, Oak Wood Handle	5"	Doz	1/12
KB-30W	Pointed Tip, Oak Wood Handle	5"	Doz	1/12



**WOODEN HANDLE STEAK KNIVES**

ITEM	DESCRIPTION	BLADE	UOM	CASE
K-55W	Rounded Tip	4-1/2"	Doz	1/48
K-45W	Pointed Tip	4-1/2"	Doz	1/48
K-438W	Pointed Tip and Handle	4-3/8"	Doz	1/24
K-35W	Economy, Pointed Tip	4"	Doz	1/48

**HOLLOW HANDLE KNIVES**

ITEM	DESCRIPTION	O.L.	UOM	CASE
0015-10	Lafayette Dinner Knife	9-1/4"	Doz	1/15
0015-11	Lafayette Steak Knife	9-1/4"	Doz	1/15
0030-15	Shangarila Table Knife	9-1/4"	Doz	1/15
0034-15*	Stanford Dinner Knife	8-3/4"	Doz	1/15
0034-18*	Stanford Table Knife	9-5/8"	Doz	1/15

\*0034-15 & 0034-18 are suitable with any of our 18/8 patterns.

**HOLLOW HANDLE KNIVES**



# VIRTUOSO

EXTRA HEAVYWEIGHT SERIES

CONDENSATION CHANNEL KEEPS TABLE DRY



101A



101B



103A



103B

ITEM	DESCRIPTION	UOM	CASE
101A	8 Qt Full-Size, Gold-Tone Accents	Set	1
101B	8 Qt Full-Size, Stainless Steel	Set	1
103A	6 Qt Round, Gold-Tone Accents	Set	1
103B	6 Qt Round, Stainless Steel	Set	1
101-WP	Water Pan for 101A, 101B	Each	1
103-WP	Water Pan for 103A, 103B	Each	5
NSF SPF2	Food Pan for 101A, 101B, NSF	Each	6/12
602-FP	Food Pan for 103A, 103B	Each	12
SPFD-2R	Round Divided Food Pan for 103A, 103B	Each	10
C-F1	Fuel Holder with Cover	Each	12/48

Create the ultimate modern buffet presentation with the *Virtuoso* collection of premium chafers. Featuring beautiful, clean styling in either all mirror finish stainless steel or gold-tone accented options.

- ◆ 18/8 stainless steel mirror finish
- ◆ Roll-top cover opens to 90° or 180°
- ◆ Condensation from cover interior drips into water pan and keeps table surface dry
- ◆ Includes food pan, water pan and fuel holder(s)
- ◆ Stackable

SEE PAGE 74 FOR MATCHING VIRTUOSO COFFEE URNS



Stackable



Open to 90°



Open to 180°



# VINTAGE

EXTRA HEAVYWEIGHT SERIES



108A



308A

Create the most elegant buffet setting with the *Vintage collection* premium chafers. Each size features a gleaming, mirror finish dome cover, and accented with gold-tone handles and curved legs.

- ◆ Stainless steel mirror finish
- ◆ Roll-top cover opens to 90° or 160°
- ◆ Includes food pan, water pan and fuel holder(s)

ITEM	DESCRIPTION	UOM	CASE
108A	8 Qt Full-Size	Set	1
308A	6 Qt Round	Set	1
108A-WP	Water Pan for 108A	Each	10
602-WP	Water Pan	Each	12
 SPF2	Food Pan for 108A, NSF	Each	6/12
602-FP	Food Pan for 308A	Each	12
SPFD-2R	Round Divided Food Pan for 308A	Each	10
C-F1	Fuel Holder with Cover	Each	12/48



Open to 90°

**MADISON**  
HEAVYWEIGHT SERIES



601



602



603

- ◆ A modern design, perfect for casual and formal settings
- ◆ Stainless steel with highly polished mirror finish dome covers
- ◆ Roll-top covers can stay open at any angle
- ◆ Includes food pan, water pan and fuel holder(s)

ITEM	DESCRIPTION	UOM	CASE
601	8 Qt Full-Size	Set	1
602	6 Qt Round	Set	1
603	8 Qt Oval	Set	1
C-WPF	Water Pan for 601	Each	6
602-WP	Water Pan for 602	Each	12
603-WP	Water Pan for 603	Each	6
NSF SPF2	Food Pan for 601, NSF	Each	6/12
602-FP	Food Pan for 602	Each	12
SPFD-2R	Round Divided Food Pan for 602	Each	10
603-FP	Food Pan for 603	Each	10
C-F1	Fuel Holder with Cover	Each	12/48

SEE PAGE 71 FOR  
ELECTRIC WATER  
PAN TO FIT FULL-SIZE  
CHAFERS



Cover stays open at any angle

**DALLAS**  
HEAVYWEIGHT SERIES



C-5080

- ◆ Solid design accented with gold-tone handles
- ◆ Available with lift-off or roll-top cover options
- ◆ Polished stainless steel with mirror finish covers
- ◆ Includes food pan, water pan and fuel holder(s)

ITEM	DESCRIPTION	UOM	CASE
C-5080	8 Qt Full-Size, Roll-top	Set	1
C-RTC	Roll-top Cover for C-5080	Each	1
C-WPF	Water Pan for C-5080	Each	6
NSF SPF2	Food Pan for C-5080, NSF	Each	6/12
C-F1	Fuel Holder with Cover	Each	12/48



Open

- ◆ Elegance combined with ornate details; the Crown collection is designed exclusively for formal settings
- ◆ Stainless steel mirror finish
- ◆ Sculpted handles and legs
- ◆ Includes food pan, water pan and fuel holder(s)

**CROWN**  
**MEDIUM-WEIGHT SERIES**

ITEM	DESCRIPTION	UOM	CASE
▶ 408-1	8 Qt Full-Size	Set	1
▶ 508	4 Qt Half-Size, Square	Set	1
▶ 708	6 Qt Round	Set	1
C-WPF	Water Pan for 408-1	Each	6
508-WP	Water Pan for 508	Each	6
708-WP	Water Pan for 708	Each	1/6
NSF: SPF2	Food Pan for 408-1, NSF	Each	6/12
508-FP	Food Pan for 508	Each	10
708-FP	Food Pan for 708	Each	1/6
C-F1	Fuel Holder with Cover	Each	12/48



408-1



508



708

- ◆ Classic art deco design with gold-tone accents
- ◆ Polished stainless steel with mirror finish covers
- ◆ 8 quart full-size chafer features a frame clip for the cover
- ◆ Includes food pan, water pan and fuel holder(s)

**MALIBU**  
**MEDIUM-WEIGHT SERIES**

ITEM	DESCRIPTION	UOM	CASE
▶ 201	8 Qt Full-Size	Set	1
▶ 202	6 Qt Oval	Set	1
▶ 203	4 Qt Round	Set	1
C-WPF	Water Pan for 201	Each	6
202-WP	Water Pan for 202	Each	12
203-WP	Water Pan for 203	Each	12
NSF: SPF2	Food Pan for 201, NSF	Each	6/12
202-FP	Food Pan for 202	Each	12
203-FP	Food Pan for 203	Each	12
C-F1	Fuel Holder with Cover	Each	12/48



201



202



203

**NEWBURG**  
ECONOMY-WEIGHT SERIES

- ◆ Simple, elegant and functional design
- ◆ Clips on frame conveniently hold cover when open
- ◆ High legs allow for extra space to prevent fuel holder bottoms from overheating table surface
- ◆ Includes water pan, food pan, two fuel holders and plastic handle

ITEM	DESCRIPTION	UOM	CASE
C-3080B	8 Qt Full-Size	Set	1
C-WPF	Water Pan for C-3080B	Each	6
NSF SPF2	Food Pan for C-3080B, NSF	Each	6/12
C-F1	Fuel Holder with Cover	Each	12/48



C-3080B



Handy clips hold cover in place

**GET-A-GRIP™**  
PATENTED HANDLE SYSTEM

- ◆ Simple design with patented food pan that features safety handles, preventing steam burns
- ◆ Clips on frame conveniently hold cover when open
- ◆ Includes water pan, specially designed food pan and two fuel holders

ITEM	DESCRIPTION	UOM	CASE
C-2080B	8 Qt Full-Size	Set	1
C-WPF	Water Pan for C-2080B	Each	6
SPF2-HD	Food Pan with Handle for C-2080B	Each	6
C-F1	Fuel Holder with Cover	Each	12/48



C-2080B



Handy clips hold cover in place



Patented Get-A-Grip™ handle system

A great solution for the on-the-go caterer, this sturdy and heavyweight full-size chafers features foldable sculpted legs, providing convenience without sacrificing elegance. The legs fold down and reassemble in seconds, perfect for space saving storage, and especially convenient for transporting food to events.

**BELLAIRE FOLDING CHAFER  
HEAVYWEIGHT SERIES**

SOLID FRAME  
CONSTRUCTION  
PROVIDES EXTRA  
STABILITY

- ◆ Constructed of stainless steel with built-in clips to hold covers in place for easy and convenient refilling and serving
- ◆ Includes water pan, food pan, frame & two fuel holders

ITEM	DESCRIPTION	UOM	CASE
C-1080	8 Qt Full-Size	Set	1
C-WPF	Water Pan for C-1080	Each	6
NSF SPF2	Food Pan for C-1080, NSF	Each	6/12
C-F1	Fuel Holder with Cover	Each	12/48



C-1080



C-1080 Folding Frame

Lighter in weight for maximum mobility, the simple design of this folding chafers is versatile enough to serve up food at any event.

**FOLDING CHAFER  
ECONOMY-WEIGHT SERIES**

- ◆ Constructed of stainless steel with built-in clips to hold covers in place for easy and convenient refilling and serving
- ◆ Includes water pan, food pan, frame & two fuel holders

ITEM	DESCRIPTION	UOM	CASE
C-4080	8 Qt Full-Size	Set	1
C-WPF	Water Pan for C-4080	Each	6
NSF SPF2	Food Pan for C-4080, NSF	Each	6/12
C-F1	Fuel Holder with Cover	Each	12/48



C-4080



C-4080 Set



C-4080 Folding Frame

**SOUP WARMERS**  
**STAINLESS STEEL**



211



207

**STAINLESS STEEL SOUP WARMERS**

Enhance the look of a serving table with these stainless steel chafers-style soup warmers, available in 7 and 11 quart capacities.

- ◆ Includes cover, water pan and fuel can holder

ITEM	DESCRIPTION	UOM	CASE
211	11 Qt Warmer	Set	1
207	7 Qt Warmer	Set	1
211-WP	Water Pan for 211	Each	12
207-WP	Water Pan for 207	Each	12
INSC-11M	Cover For 11 Qt Inset	Each	6/36
INSC-7M	Cover For 7 Qt Inset	Each	6/48
INSH-11	Hinged Cover For 11 Qt Inset	Each	6/24
INSH-7	Hinged Cover For 7 Qt Inset	Each	6/24
C-F1	Fuel Holder with Cover	Each	12/48



**HEAT BOOST TWIST-CAP CHAFING FUEL CANS**



**HEAT BOOST TWIST-CAP CHAFING FUEL CANS**

These wick-type reusable chafers fuel cans fit any standard fuel holder. The screw-on cap provides a secure seal for transporting and storage.

- ◆ Diethylene glycol fuel; odorless
- ◆ Twist-cap for easy open and close
- ◆ Wick-type, reusable, able to relight
- ◆ Recommended for chafing dishes and beverage urns
- ◆ Available in 2- / 4- / 6-hour burn times
- ◆ Sold in full case only



C-F2



C-F6

ITEM	DESCRIPTION	UOM	CASE
C-F2	Chafing Fuel, 2 Hour Burn Time	Each	24
C-F4	Chafing Fuel, 4 Hour Burn Time	Each	24
C-F6	Chafing Fuel, 6 Hour Burn Time	Each	24



**ELECTRIC WATER PAN**

Add ease and convenience with this versatile, energy efficient 120 Volt alternative to chafing fuels. It fits most full-size chafer stands or use as a freestanding unit.

- ◆ Stands alone or fits standard full-size chafer frames for an electric alternative (food pan sold separately)
- ◆ Accommodates full-size steam table pans
- ◆ Powerful, efficient 900W heating element warms faster; temperature is adjustable
- ◆ 120V~60Hz, 900W, 7.5A
- ◆ Dimensions: 22-5/8"L x 13-5/8"W x 7"H
- ◆ One year parts and labor warranty

ITEM	DESCRIPTION	UOM	CASE
EWP-2	900W, Full Size	Each	1

**ELECTRIC 900W WATER PAN**



Holds full-size steam table pan and fits in standard full-size chafers

EWP-2 

**CHAFER STAND FOR STEAM PANS & WATER PANS**

- ◆ Only fits steam table pans and water pans
- ◆ Do not use with aluminum foil pans

ITEM	DESCRIPTION	UOM	CASE
C-3F	Full-Size Stand	Each	10

**CHAFING PAN HOLDERS**

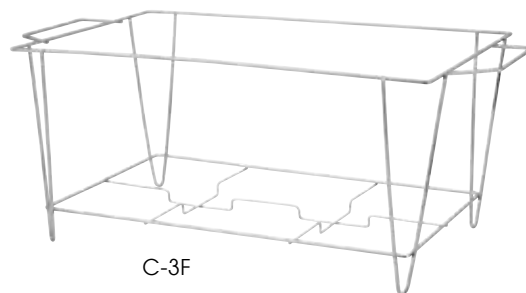

C-3F

**CHAFER STAND FOR ALUMINUM FOIL TRAYS**

ITEM	DESCRIPTION	UOM	CASE
C-2F	Full-Size Stand	Each	10



C-2F shown with trays

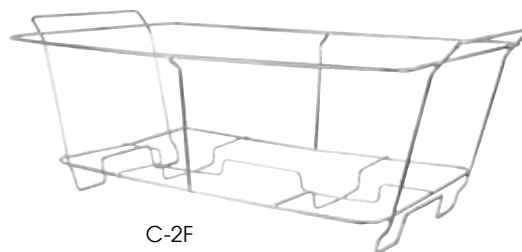

C-2F

# winco® SPECTRUM™ DROP-IN INDUCTION COOKERS



EIDS-SERIES

Control panel mounts to front of counter where drop-in cooker is installed



Drop-in induction cooker mounted in counter



EIDS-18  
For U.S. only



EIDS-18C  
For Canada only



EIDS-34  
For U.S. and Canada



EIDS-TR



## DROP-IN INDUCTION COOKERS

Safer than traditional gas or electric resistance burners, induction cooktops use magnetism to rapidly heat up induction cookware, which in turn heats up food. The drop-in induction cookers install directly into the countertop for a built-in, streamlined presentation. Ideal for tableside, catering or buffet-line cooking.

- ◆ Powder-coated steel body construction
- ◆ Compact drop-in-counter design that can be flush, recessed, or mounted with optional trim ring
- ◆ Easy to use digital control with ten (10) power wattage levels from warming to cooking for optimal cooking efficiency, control and speed
- ◆ Remote control panel provided with 36" (915mm) quick-connect cord
- ◆ High-impact and high-heat resistant 11-13/16" x 11-13/16" (299mm x 299mm) glass-ceramic cooking surface
- ◆ Accommodates pan sizes between 4-1/2" (114 mm) to 10-1/2" (267mm)
- ◆ Small-article and pan detection
- ◆ Timer up to 150 min (2-1/2 hours)
- ◆ Auto safety shut-off
- ◆ One year parts and labor warranty

ITEM	OVERALL DIMENSIONS			POWER	PLUG & CORD	SHIP WEIGHT
	LENGTH	DEPTH	HEIGHT			
EIDS-18				120V~60Hz, 1800W, 15A	NEMA 5-15P	27.7 lbs (12.56 kgs)
EIDS-18C	12-5/8" (320mm)	13-7/16" (340mm)	3-7/8" (98mm)	120V~60Hz, 1800W, 15A	NEMA 5-20P	
EIDS-34				240V~60Hz, 3400W, 14A	NEMA 6-20P	



ITEM	DESCRIPTION	UOM	CASE
EIDS-18	US	Set	1/2
EIDS-18C	Canada	Set	1/2
EIDS-34	US and Canada	Set	1/2

## TRIM RING FOR DROP-IN INDUCTION COOKERS

For a sleek look, install the drop-in induction cookers with this additional trim ring to protect the glass edges and hide the countertop cutout.



ITEM	DESCRIPTION	UOM	CASE
EIDS-TR	Stainless Steel Trim Ring	Each	1

## ECONOMY INDUCTION COOKER



EIC-400E  
For U.S. only



## ECONOMY COUNTERTOP INDUCTION COOKER

- ◆ Up to 1800 watts of continuous heat to cook everything from a low simmer to a rolling boil
- ◆ Easy-touch controls with adjustable power levels (1-10)
- ◆ Ceramic glass surface with small-article and pan detection, 4-3/4"-10-1/4" induction cookware
- ◆ Durable stainless steel and plastic body construction
- ◆ Timer up to 180 min. (3 Hours)
- ◆ One year parts and labor warranty

ITEM	OVERALL DIMENSIONS			POWER	PLUG	SHIP WEIGHT
	LENGTH	DEPTH	HEIGHT			
EIC-400E	11-3/4" (299mm)	15-3/4" (400mm)	2-3/4" (70mm)	120V~60Hz, 1800W, 15A	NEMA 1-15P	13.25 lbs (6.01 kgs)



ITEM	DESCRIPTION	UOM	CASE
EIC-400E	Induction Cooker	Each	1/4

## COUNTERTOP INDUCTION COOKERS

Safer than traditional gas or electric resistance burners, induction cooktops use magnetism to rapidly heat up induction cookware, which in turn heats up food. The ideal choice for tableside, catering and buffet-line cooking, induction cooktops are faster and more efficient than installed gas stovetops.

- ◆ Stainless steel body construction
- ◆ Compact, easy-to-clean, portable
- ◆ Easy to use digitally controlled wattage and temperature from warming to cooking for optimal cooking efficiency, control and speed
- ◆ High-impact and high-heat resistant 11-13/16" x 11-13/16" (299mm x 299mm) glass-ceramic cooking surface
- ◆ Accommodates pan sizes between 4-1/2" (114 mm) to 10-1/2" (267mm)
- ◆ Small-article and pan detection
- ◆ Timer up to 150 min (2-1/2 hours)
- ◆ Auto safety shut-off
- ◆ One year parts and labor warranty

SEE PAGE 197  
FOR INDUCTION-  
READY  
COOKWARE

ITEM	OVERALL DIMENSIONS			POWER	PLUG	SHIP WEIGHT
	LENGTH	DEPTH	HEIGHT			
EICS-18	14-3/16"	18-1/8"	5-1/8"	120V-60Hz, 1800W, 15A	NEMA 5-15P	37.5 lbs (17.01 kgs)
EICS-18C	(360mm)	(460mm)	(129mm)	120V-60Hz, 1800W, 15A	NEMA 5-20P	
EICS-34				240V-60Hz, 3400W, 14A	NEMA 6-20P	

ITEM	DESCRIPTION	UOM	CASE
EICS-18	US	Set	1/2
EICS-18C	Canada	Set	1/2
EICS-34	US and Canada	Set	1/2

## winco<sup>®</sup> SPECTRUM<sup>™</sup> COUNTERTOP INDUCTION COOKERS

Heat Efficiency Comparison

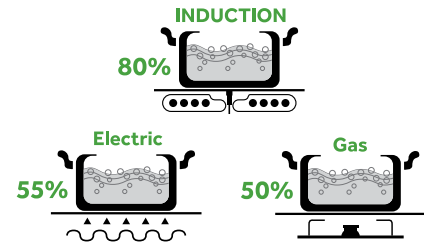

EICS-SERIES

EICS-18  
For U.S. only



EICS-18C  
For Canada only



EICS-34  
For U.S. and Canada



## DISPLAY PANS

ITEM	DESCRIPTION	SIZE (DIA X H)	UOM	CASE
SSOP-8	8"	8" x 1-3/4"	Each	1/6
SSOP-9	9-1/2"	9-1/2" x 2"	Each	1/6
SSOP-11	11"	11" x 2-1/8"	Each	1/6
SSOP-12	12-1/2"	12-1/2" x 2-1/4"	Each	1/2
SSOP-14	14"	14" x 2-1/4"	Each	1/2



## PREMIUM DISPLAY PANS STAINLESS STEEL



SSOP-8



SSOP-11



SSOP-14

SSOP-SERIES



## VIRTUOSO™ COFFEE URNS

The modern design of the Virtuoso urns will add a stylish touch to any coffee and tea self-service station. The gleaming mirror-finish body is available in 3 gallon (11.3L) and 5 gallon (18.9L) capacities. A single fuel canister will keep contents warm and ready for dispensing.

- ◆ Extra-heavyweight stainless steel
- ◆ Available with gold-tone accents or all stainless steel
- ◆ Mirror finish



905A



903A



905B



903B

ITEM	DESCRIPTION	UOM	CASE
905A	5 Gal (18.9L), Two-Tone	Set	1
905B	5 Gal (18.9L), Stainless Steel	Set	1
903A	3 Gal (11.3L), Two-Tone	Set	1
903B	3 Gal (11.3L), Stainless Steel	Set	1
FAUCET-CU	Stainless Steel Faucet	Each	1
FAUCET-JD	Plastic Faucet	Each	1



FAUCET-CU



FAUCET-JD

SEE PAGE 64 FOR MATCHING VIRTUOSO CHAFERS



## VIRTUOSO™ JUICE DISPENSER

### VIRTUOSO™ JUICE DISPENSER

The Virtuoso design is now available in a dispenser for cold beverages, complete with center ice core to keep drink offerings chilled without watering them down. Ideal for infused water, ice tea, juice, lemonade and more.

- ◆ Break-resistant, clear plastic container provides excellent product visibility
- ◆ Mirror finish stainless steel base, core and lid for optimal durability
- ◆ Hand wash recommended to maintain ideal condition; do not use abrasive cleaners

**NEW**



908  
11-1/2"L x 13-1/2"W x 21"H  
6-1/2"H base

COOL & REFRESHING, NOT WATERED DOWN



ITEM	DESCRIPTION	UOM	CASE
908	3 Gal (11.3L), Mirror S/S	Set	1



CHILL WITH ICE CORE

These beverage dispensers are perfect for serving refreshing, cool drinks. Fill the inner center tube with ice to chill from within without watering down beverages.

## COLD BEVERAGE DISPENSERS

- ◆ Ice core allows chilling without watering down
- ◆ Break-resistant polycarbonate containers
- ◆ Removable container and drip tray for easy cleaning
- ◆ Maintain ideal condition and clean by hand with warm, soapy water and soft cloth/sponge; abrasive cleaners will scratch the surface

### PEDESTAL JUICE DISPENSERS WITH ICE CORE

- ◆ Mirror finish; available with either gold-tone accents or all stainless steel details
- ◆ Break-resistant, clear plastic container provides excellent product visibility
- ◆ Ideal for juice and a variety of cold beverages

ITEM	DESCRIPTION	UOM	CASE
901	2.2 Gal (8.3L), Two-Tone	Set	1
902	2.2 Gal (8.3L), Stainless Steel	Set	1

### ACCESSORIES FOR JUICE DISPENSERS

- ◆ Clean polycarbonate container by hand with warm, soapy water and soft cloth/sponge; abrasive cleaners will scratch the surface

ITEM	DESCRIPTION	UOM	CASE
901-FN	Faucet for 901, 902	Each	12/48
901-P1	PC Jar for 901, 902	Each	4

CHILL WITH ICE CORE



902  
10-1/8"L x 13-3/4"W x 21-1/4"H



901  
10-1/8"L x 13-3/4"W x 21-1/4"H



901-FN



901-P1

### COLD BEVERAGE DISPENSER WITH ICE CORE

- ◆ Fill the ice core to keep beverages chilled without diluting
- ◆ Break-resistant, clear plastic container provides excellent product visibility
- ◆ 8" high base is detachable for compact storage
- ◆ Brushed finish stainless steel base, core and lid for optimal durability
- ◆ Tight-fitting lid keeps contents free from contaminants
- ◆ Ideal for infused water, juice, iced tea and more
- ◆ Hand wash recommended to maintain ideal condition; do not use abrasive cleaners

ITEM	DESCRIPTION	UOM	CASE
904	2.25 Gal (8.51L), Brushed S/S	Set	1/4



Fill center tube with ice



904  
9-1/8"L x 10"W x 22"H  
8"H base

### DRIP TRAYS

- ◆ Removable grid for easy cleaning; dishwasher safe
- ◆ Each pack contains four (4) pieces
- ◆ BPA-free

ITEM	DESCRIPTION	UOM	CASE
DT-45	4-1/2" Tray, 4 pcs/pk	Pack	12/24
DT-60	6" Tray, 4 pcs/pk	Pack	12/24

### DRIP TRAYS



DT-45



DT-60

NSF

DT-SERIES

BPA FREE



## PUNCH BOWL



SPB-35

## STAINLESS STEEL PUNCH BOWL

- ◆ Mirror finish
- ◆ Footed base
- ◆ Decorative ring handles

ITEM	DESCRIPTION	UOM	CASE
SPB-35	3-1/2 Gal (13.25L)	Each	6

## STAINLESS STEEL BEVERAGE SIGNS



SGN-SERIES TENT SIGNS

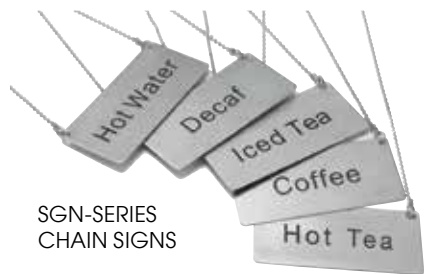

SGN-SERIES CHAIN SIGNS

With oversized black letters on stainless steel, these beverage tent and chain signs are must-haves for buffets and beverage stations.

## STANDING TENT SIGNS

- ◆ 3"L x 1-1/4"H x 1-1/2"D

ITEM	DESCRIPTION	UOM	CASE
SGN-100	Blank Sign	Each	12/120
SGN-101	Hot Tea	Each	12/120
SGN-102	Decaf	Each	12/120
SGN-103	Coffee	Each	12/120
SGN-104	Hot Water	Each	12/120
SGN-105	Iced Tea	Each	12/120

## HANGING CHAIN SIGNS

- ◆ 3-1/2"L x 1-3/4"W sign with 12" long chain

ITEM	DESCRIPTION	UOM	CASE
SGN-201	Hot Tea	Each	12/120
SGN-202	Decaf	Each	12/120
SGN-203	Coffee	Each	12/120
SGN-204	Hot Water	Each	12/120
SGN-205	Iced Tea	Each	12/120

## CLIPS & HOLDERS



MH-1



MH-2



MH-2C

## MENU HOLDER CLIPS

ITEM	DESCRIPTION	SIZE	UOM	CASE
MH-1	Harp Clip, Heavy-Cast Base	1"L x 1"W x 1-1/2"H	Doz	10/60
MH-2	Ring-Type	2-1/2" x 2-1/3"	Doz	2/20
MH-2C	Clip	2-1/2" x 2-1/2"	Doz	1/40



TCD-2



TCD-3C



TCD-3S



## TABLE SIGN HOLDERS

Stylish and discreet, these table sign holders are perfect for buffet and table seating.

ITEM	DESCRIPTION	UOM	CASE
TCD-2	Table Sign Holder, Cast Aluminum, 2 pcs/pk	Pack	24/240
TCD-3C	Table Sign Clip, "C" Base, 6 pcs/pk	Pack	4/96
TCD-3S	Table Sign Clip, "S" Base, 6 pcs/pk	Pack	4/96
TCD-4D	Table Sign Clip, Double Sided Clips, Flexible, 6 pcs/pk	Pack	48/192
TCD-4S	Table Sign Clip, Acrylic Square Base, 6 pcs/pk	Pack	4/48



TCD-4D



TCD-4S

Made of 18/8 stainless steel, the surfaces of these trays and risers exhibit a glossy ripple effect in a gleaming mirror-finish, truly unique and elegant pieces for showcasing appetizers and desserts.

- ◆ Durable and stable surface for displaying
- ◆ Not recommended for prolonged use with acidic, creamy or salty ingredients
- ◆ Hand wash recommended

## DISPLAY TRAYS & RISERS

### NESTING RISER DISPLAY

- ◆ 4-piece nesting set

ITEM	DESCRIPTION	UOM	CASE
HRS-4	Riser 1: 5-1/2" x 5-1/2" x 5-1/2" Riser 2: 6-5/8" x 6-5/8" x 6-5/8" Riser 3: 7-7/8" x 7-7/8" x 7-7/8" Riser 4: 9" x 9" x 9"	Set	4



HRS-4

### DISPLAY TRAYS

- ◆ Available in a variety of shapes and sizes

ITEM	DESCRIPTION	SIZE	UOM	CASE				
HPO-14	Rectangular	13-3/4" x 7-3/4" x 1"	Each	12				
HPO-15	Rectangular	15" x 8-1/2" x 1"	Each	12				
HPS-10	Square	10-1/4" x 10-1/4" x 5/8"	Each	12				
HPS-12	Square	11-3/4" x 11-3/4" x 5/8"	Each	12				
HPR-8	Round	8-7/8"Dia x 1-5/8"	Each	12				
HPR-9	Round	9-5/8"Dia x 1-5/8"	Each </tr <tr> <td>HPR-10</td> <td>Round</td> <td>10-1/4"Dia x 1-5/8"</td> <td>Each</td> <td>12</td> </tr>	HPR-10	Round	10-1/4"Dia x 1-5/8"	Each	12
HPR-10	Round	10-1/4"Dia x 1-5/8"	Each	12				

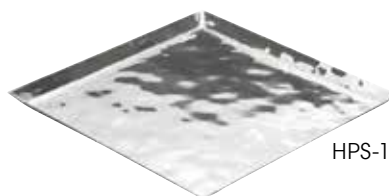

HPS-12



HPR-10

## CHROME SERVING TRAYS

The classic gadroon edge and traditional engraving of these chrome-plated trays are perfect for tea and coffee service, as well as pastries, appetizers and desserts.

- ◆ Available in a variety of shapes and sizes
- ◆ Not recommended for prolonged use with meat or acidic ingredients
- ◆ Hand wash only

## CHROME SERVING TRAYS

ITEM	DESCRIPTION	SIZE	UOM	CASE
CMT-1912	Rectangular with Handles	19-1/2" x 12-1/2"	Each	12/24
CMT-1217	Octagonal	17" x 12-1/2"	Each	12/24
CMT-1420	Octagonal	20" x 14"	Each	12/24
CMT-1812	Rectangular	18" x 12-1/2"	Each	12/24
CMT-2014	Rectangular	20" x 14"	Each	12/24
CMT-1014	Oval	14-3/4" x 10-1/2"	Each	12/24
CMT-1318	Oval	18-3/4" x 13"	Each	12/24
CMT-14	Round	14"	Each	12/24



CMT-1912



CMT-1420



CMT-14



CMT-1318



CMT-2014

**STAINLESS STEEL  
BUFFET SERVICE**



BW-NS3 BW-SL2 BW-SS1



BW-BF BW-CF BW-PS5 BW-WPS6



BW-DL BW-DK8 BW-DK9



BW-SP1 BW-SP2 BW-TN

**HOLLOW HANDLE BUFFETWARE**

*Plating and serving has never been easier than with our collection of hollow handle stainless steel buffetware.*

ITEM	DESCRIPTION	LENGTH	UOM	CASE
BW-NS3	Notched Spoon	11-3/4"	Each	12/72
BW-SL2	Slotted Spoon	11-3/4"	Each	12/72
BW-SS1	Solid Spoon	11-3/4"	Each	12/72
BW-BF	Pot Fork, Two Tines	11"	Each	12/72
BW-CF	Cold Meat Fork	10"	Each	12/72
BW-PS5	Pie Server	11"	Each	12/72
BW-WPS6	Wide Pie Server	11-1/2"	Each	12/72
BW-DL	Deep Ladle	4 Oz	Each	12/72
BW-DK8	Carving Knife, Wave-Edge Blade	8"	Each	12/72
BW-DK9	Slicer/Wedding Cake Knife, Wave-Edge	9"	Each	12/72
BW-SP1	Spout Ladle	1 Oz	Each	12/72
BW-SP2	Spout Ladle	2 Oz	Each	12/72
BW-TN	Perforated Turner	14"	Each	12/72





**SHANGARILA SERVING PIECES**

◆ Extra-heavyweight 18/8 stainless steel mirror finish

ITEM	DESCRIPTION	LENGTH	UOM	CASE
0030-21	Large Bowl Serving Spoon	9"	Doz	1/10
0030-22	Cold Meat Fork	8-1/2"	Doz	1/10
0030-23	Solid Spoon	11-1/2"	Doz	1/10
0030-24	Banquet Slotted Spoon	11-1/2"	Doz	1/10
0030-25	Banquet Fork	12"	Doz	1/10

**STAINLESS STEEL  
BUFFET SERVICE**

SHANGARILA  
SERVING  
PIECES

SEE PAGE 46 FOR  
COORDINATING  
SHANGARILA  
FLATWARE



**ELEGANCE SERVING PIECES**

ITEM	DESCRIPTION	LENGTH	UOM	CASE
LE-1	Gravy & Soup Ladle, 1 Oz	7"	Doz	1/36
LE-2	Gravy & Soup Ladle, 2 Oz	9"	Each	12/120
LE-4	Gravy & Soup Ladle, 4 Oz	13"	Each	12/120
LE-11	Solid Spoon	11"	Each	12/120
LE-13	Solid Spoon	13"	Each	12/120
LE-20	Fork	13"	Each	12/120



**SERVING SPOONS**

ITEM	DESCRIPTION	LENGTH	UOM	CASE
SRS-2	Round Edge	8-5/8"	Doz	1/25
SRS-8	Flat Edge	8-1/4"	Doz	1/25



**SPAGHETTI SERVERS**

ITEM	DESCRIPTION	LENGTH	UOM	CASE
STS-9	Small	9"	Each	12/144
STS-13	Large	13"	Each	12/144



**STAINLESS STEEL SERVING TONGS**



STH-10



PTOS-8



ST-10S



ST-105SF



PT-8



PT-875



ST-2



ST-10



ST-8



ICT-7



ICT-7 Texture



IT-7



PT-6

**SERVING TONGS**

These heavyweight, 18/8 satin-finish stainless steel serving tongs are designed for comfortable service in elegant settings.

- ◆ Great for buffets, catered events and more
- ◆ Dishwasher safe

ITEM	DESCRIPTION	SIZE	UOM	CASE
STH-8	Short	8-1/2"	Each	12/72
STH-10	Medium	10-1/2"	Each	12/72
STH-13	Long	13-1/2"	Each	12/72

**SALAD TONGS**

ITEM	DESCRIPTION	SIZE	UOM	CASE
PTOS-8	Oval Salad Tong, Satin Finish	7-3/4"	Each	12/96
ST-2	Double Spoon, Mirror Finish	10"	Each	6/60
ST-10	Fork and Spoon, Satin Finish	10"	Each	6/60
ST-10S	Slotted and Solid Spatula, Mirror Finish	10"	Each	12/96
ST-105SF	Spatula and Fork, Mirror Finish	10-1/2"	Each	12/96

**PASTRY TONGS**

ITEM	DESCRIPTION	SIZE	UOM	CASE
PT-8	Solid with Short Handle	7-1/2"	Each	12/120
PT-875	Solid with Long Handle	8-3/4"	Each	12/144
PT-10P	Perforated Scissor Style	10-1/2"	Each	12/96



PT-10P

**SPAGHETTI TONGS**

ITEM	DESCRIPTION	SIZE	UOM	CASE
ST-8	Mirror Finish	8"	Each	12/240

**ICE TONGS**

ITEM	DESCRIPTION	SIZE	UOM	CASE
ICT-7	Five Prong, Textured 7"	7"	Each	12/144
IT-7	Three Prong, Satin Finish	7"	Each	12/120

**POM TONGS**

ITEM	DESCRIPTION	SIZE	UOM	CASE
PT-6	Satin Finish	6"	Doz	4/24
PT-9	Satin Finish	9"	Doz	4/24

- ◆ Save money - the edges of Curv™ utensils get into tight corners and eliminate waste
- ◆ No dripping with contoured pouring spouts
- ◆ Molded-in stopper on spoon handle prevents slipping into pan/pot
- ◆ Textured exterior finish provides a secure grip
- ◆ Easy-clean smooth, high-gloss interior finish

## POLYCARBONATE SERVING UTENSILS

WITHSTANDS TEMPS FROM -40°F TO 212°F

**CURV™**  
BY WINCO®



CVLD-SERIES NSF

### **CURV™ ONE-PIECE DUAL SPOUT LADLES**

ITEM	DESCRIPTION	SIZE	UOM	CASE
CVLD-8C	Clear 3/4 oz	8-1/2"	Each	12/144
CVLD-8K	Black 3/4 oz	8-1/2"	Each	12/144
CVLD-8R	Red 3/4 oz	8-1/2"	Each	12/144
CVLD-13C	Clear 1 oz	13"	Each	12/144
CVLD-13K	Black 1 oz	13"	Each	12/144
CVLD-13R	Red 1 oz	13"	Each	12/144

### **CURV™ DUAL SPOUT SERVING SPOONS**

- ◆ 1-1/2 oz capacity

ITEM	DESCRIPTION	SIZE	UOM	CASE
CVSS-13C	Clear Solid	13"	Each	12/144
CVSS-13K	Black Solid	13"	Each	12/144
CVSS-13R	Red Solid	13"	Each	12/144
CVSS-15C	Clear Solid	15"	Each	12/144
CVSS-15K	Black Solid	15"	Each	12/144
CVSS-15R	Red Solid	15"	Each	12/144
CVPS-13C	Clear Perforated	13"	Each	12/144
CVPS-13K	Black Perforated	13"	Each	12/144
CVPS-13R	Red Perforated	13"	Each	12/144
CVPS-15C	Clear Perforated	15"	Each	12/144
CVPS-15K	Black Perforated	15"	Each	12/144
CVPS-15R	Red Perforated	15"	Each	12/144



CVSS-SERIES & CVPS-SERIES NSF

### **CURV™ TAPERED BUFFET SPOONS**

- ◆ 3/4 oz capacity

ITEM	DESCRIPTION	SIZE	UOM	CASE
CVBS-10C	Clear	10"	Each	12/144
CVBS-10K	Black	10"	Each	12/144
CVBS-10R	Red	10"	Each	12/144



CVBS-SERIES NSF

### **CURV™ SERVING TONGS**

ITEM	DESCRIPTION	SIZE	UOM	CASE
CVST-6C	Clear	6"	Each	12/144
CVST-6K	Black	6"	Each	12/144
CVST-6R	Red	6"	Each	12/144
CVST-9C	Clear	9"	Each	12/144
CVST-9K	Black	9"	Each	12/144
CVST-9R	Red	9"	Each	12/144
CVST-12C	Clear	12"	Each	12/144
CVST-12K	Black	12"	Each	12/144
CVST-12R	Red	12"	Each	12/144

DURABLE AND FUNCTIONAL



CVST-SERIES NSF

### **SPAGHETTI TONGS**

- ◆ Heat-resistant up to 302°F (150°C)

ITEM	DESCRIPTION	SIZE	UOM	CASE
PPT-11B	Beige	11"	Each	24/144
PPT-11C	Clear	11"	Each	24/144
PPT-11K	Black	11"	Each	24/144

### **FLAT TONGS**

- ◆ Textured grip

ITEM	DESCRIPTION	SIZE	UOM	CASE
PUTF-6B	Beige	6"	Each	12/432
PUTF-6C	Clear	6"	Each	12/432
PUTF-6K	Black	6"	Each	12/432



PPT-SERIES NSF

PUTF-6K PUTF-SERIES NSF



**SINGLE-SERVE MINI CAST IRON COOKWARE**

**FIREIRON™ MINI CAST IRON COOKWARE**

Artfully present single-serve portions in mini enameled cast iron cookware.

- ◆ Skillets (CAST-3 & CAST-5) include an ergonomic thumbrest for comfortable grip
- ◆ Lip under dual handles allows for easier handling and better grip
- ◆ Use on multiple cooking surfaces, including induction



ITEM	DESCRIPTION	CAPACITY	UOM	CASE
CAST-3	3-1/2" Dia	3 Oz	Each	6
CAST-5	4-7/8" Dia	7 Oz	Each	6
CASM-5R	5-1/8" Dia	12 Oz	Each	6
CASM-6R	6-3/8" Dia	14 Oz	Each	6
CASM-6O	6-1/2" x 4-1/4"	9 Oz	Each	6
CASM-7O	7-3/8" x 5-3/8"	16 Oz	Each	6
CASM-4S	4-7/8" Square	10 Oz	Each	6
CASM-5RT	5-7/8" x 4-1/8"	10 Oz	Each	6
CASM-7RT	7" x 4-3/4"	14 Oz	Each	6

ENAMELED

SEE PAGE 209 FOR FULL-SIZE CAST IRON COOKWARE



The lip under each handle allows for easier handling and better grip

INDUCTION READY CAST-SERIES & CASM-SERIES

**CAST IRON MINI WOK**

**CAST IRON CASSEROLE WOK**

- ◆ Authentic cast iron wok in mini tabletop serving size



ITEM	DESCRIPTION	CAPACITY	UOM	CASE
CSW-75	7"Dia x 2"H, Non-Stick	19 Oz	Set	12



Artfully present single-serve portions in copper and stainless steel finished tri-ply mini cookware.

- ◆ Tri-ply construction with either stainless steel or copper exterior, all induction ready
- ◆ Aluminum core provides efficient heat distribution
- ◆ 18/8 stainless steel cookware surface for superior cooking performance

## SINGLE-SERVE MINI COOKWARE

### TRI-PLY MINI COOKWARE WITH COPPER EXTERIOR

ITEM	DESCRIPTION	CAPACITY	UOM	CASE
DCCR-3C	3.75" Casserole	15 Oz	Each	1/30
DCFP-4C	4" Fry Pan	5 Oz	Each	1/30
DCSC-3C	3" Saucier	5 Oz	Each	1/30
DCSP-3C	3.5" Sauce Pan	11 Oz	Each	1/30

### TRI-PLY MINI COOKWARE WITH STAINLESS STEEL EXTERIOR

ITEM	DESCRIPTION	CAPACITY	UOM	CASE
DCCR-3S	3.75" Casserole	15 Oz	Each	1/30
DCFP-4S	4" Fry Pan	5 Oz	Each	1/30
DCSC-3S	3" Saucier	5 Oz	Each	1/30
DCSP-3S	3.5" Sauce Pan	11 Oz	Each	1/30

### TRI-PLY MINI COOKWARE LIDS

ITEM	DESCRIPTION	UOM	CASE
DCL-35	Lid for 3.5" DCSP, Sauce Pan	Each	1/50
DCL-375	Lid for 3.75" DCCR, Casserole	Each	1/50



MINI COOKWARE



DCWE-105S



DCWE-201C



DCWC-101S



DCWC-201C



DCWB-101S



DCWA-101S



DCWA-201C



DCWD-101S

Artfully cook and present single-serve portions in copper and stainless steel finish mini-ware.



STAINLESS STEEL MINI CASSEROLES

ITEM	DESCRIPTION	CAPACITY	UOM	CASE
DCWE-101S	2-3/4"Dia x 1-3/4"H	5 Oz	Each	12/36
DCWE-102S	3-1/8"Dia x 1-3/4"H	7 Oz	Each	12/36
DCWE-103S	3-1/2"Dia x 2"H	10 Oz	Each	12/36
DCWE-104S	4-1/4"Dia x 2-3/8"H	17 Oz	Each	12/36
DCWE-105S	4-3/4"Dia x 3"H	28 Oz	Each	12/36



COPPER-PLATED MINI CASSEROLES

ITEM	DESCRIPTION	CAPACITY	UOM	CASE
DCWE-201C	2-3/4"Dia x 1-3/4"H	5 Oz	Each	12/36
DCWE-202C	3-1/8"Dia x 1-3/4"H	7 Oz	Each	12/36
DCWE-203C	3-1/2"Dia x 2"H	10 Oz	Each	12/36
DCWE-204C	4-1/4"Dia x 2-3/8"H	17 Oz	Each	12/36
DCWE-205C	4-3/4"Dia x 3"H	28 Oz	Each	12/36



STAINLESS STEEL MINI FRY PANS

ITEM	DESCRIPTION	CAPACITY	UOM	CASE
DCWC-101S	4"Dia x 1-1/8"H	7 Oz	Each	12/96
DCWC-102S	4-1/2"Dia x 1-3/8"H	10 Oz	Each	12/72
DCWC-103S	5"Dia x 1-1/8"H	12 Oz	Each	12/48



COPPER MINI FRY PAN

ITEM	DESCRIPTION	CAPACITY	UOM	CASE
DCWC-201C	5-1/2"Dia x 1-3/8"H	11 Oz	Each	12/48



STAINLESS STEEL MINI TAPERED SAUCE PANS

ITEM	DESCRIPTION	CAPACITY	UOM	CASE
DCWB-101S	2-3/4"Dia x 1-3/4"H	4 Oz	Each	12/72
DCWB-102S	3-3/8"Dia x 2-3/8"H	9 Oz	Each	12/72
DCWB-103S	4"Dia x 2-3/8"H	12 Oz	Each	12/48



STAINLESS STEEL MINI SAUCE PANS

ITEM	DESCRIPTION	CAPACITY	UOM	CASE
DCWA-101S	2"Dia x 1-3/16"H	2 Oz	Each	12/120
DCWA-102S	2-3/4"Dia x 1-3/4"H	5 Oz	Each	12/120
DCWA-103S	3-1/8"Dia x 1-3/4"H	7 Oz	Each	12/96
DCWA-104S	3-1/2"Dia x 2"H	10 Oz	Each	12/48
DCWA-105S	4-3/8"Dia x 2-3/8"H	18 Oz	Each	12/48
DCWA-106S	5"Dia x 3"H	28 Oz	Each	12/48



COPPER-PLATED MINI SAUCE PANS

ITEM	DESCRIPTION	CAPACITY	UOM	CASE
DCWA-201C	2"Dia x 1-3/16"H	2 Oz	Each	12/120
DCWA-202C	2-3/4"Dia x 1-3/4"H	5 Oz	Each	12/120
DCWA-203C	3-1/8"Dia x 1-3/4"H	7 Oz	Each	12/96
DCWA-204C	3-1/2"Dia x 2"H	10 Oz	Each	12/48
DCWA-205C	4-3/8"Dia x 2-3/8"H	18 Oz	Each	12/48
DCWA-206C	5"Dia x 3"H	28 Oz	Each	12/48



STAINLESS STEEL MINI WOKS

ITEM	DESCRIPTION	CAPACITY	UOM	CASE
DCWD-101S	3-3/8"Dia x 1"H	3 Oz	Each	12/96
DCWD-102S	4"Dia x 1-3/16"H	5 Oz	Each	12/96

**STAINLESS STEEL MINI COLANDERS**

ITEM	DESCRIPTION	CAPACITY	UOM	CASE
DDSC-101S	3-3/4"Dia	2 Oz	Each	12/120
DDSC-102S	4"Dia	4 Oz	Each	12/120
DDSC-103S	5-1/8"Dia	9 Oz	Each	12/72

**MINI COLANDERS**



DDSC-101S

**STAINLESS STEEL MINI ROASTING PANS**

ITEM	DESCRIPTION	CAPACITY	UOM	CASE
DDSB-101S	4-1/2" Sq	13 Oz	Each	12/72
DDSB-102S	5-3/16" Sq	24 Oz	Each	12/48
DDSB-103S	5"L x 3-3/8"W	11 Oz	Each	12/72
DDSB-104S	5-3/4"L x 3-3/4"W	16 Oz	Each	12/72

**MINI ROASTING PANS**



DDSB-101S

DDSB-203C

**COPPER-PLATED MINI ROASTING PANS**

ITEM	DESCRIPTION	CAPACITY	UOM	CASE
DDSB-201C	4-1/2" Sq	13 Oz	Each	12/72
DDSB-202C	5-3/16" Sq	24 Oz	Each	12/48
DDSB-203C	5"L x 3-3/8"W	11 Oz	Each	12/72
DDSB-204C	5-3/4"L x 3-3/4"W	16 Oz	Each	12/72

**KADY BOWLS**

*Elegantly serve saucy dishes in our stainless steel mirror-finish kady bowls.*

- ◆ Durable stainless steel
- ◆ Elegant mirror-finish
- ◆ Welded handles for durability; easily transport hot dishes
- ◆ Great for serving, displays and more

ITEM	DESCRIPTION	CAPACITY	UOM	CASE
KDB-5	5"Dia	20 Oz	Each	6/96
KDB-6	6"Dia	28 Oz	Each	6/72
KDB-7	7"Dia	40 Oz	Each	6/48

**KADY BOWLS**



KDB-7

**CARBON STEEL COOK & SERVEWARE**

*These Spanish-made, blini pans are ideal for adding a rustic look to fresh-cooked eggs or displaying individual Mediterranean dishes. Hand wash and dry thoroughly for best results.*

- ◆ Hand wash, dry thoroughly and store in dry area

ITEM	DESCRIPTION	UOM	CASE
CSPP-4	4-3/4", Polished	Each	40
CSPP-4E	4-3/4", Non-Stick	Each	40

**MINI COOKWARE**



CSPP-4



CSPP-4E



4-3/4" DIA. INDIVIDUAL SERVING SIZE

## FRY CUPS



SFCW-4S



SFC-35



SFC-35H



WBKH-5



WBKH-10



### STAINLESS STEEL FRY CUPS

A sleek and trendy way to display side dishes. Perfect for serving fries, calamari, onion rings and other small portion finger foods!

- ◆ Durable satin-finish stainless steel
- ◆ Great for serving, displays and more
- ◆ 3-1/4" diameter x 3-1/2" high

ITEM	DESCRIPTION	UOM	CASE
SFC-35	Smooth Exterior	Each	12/120
SFC-35H	Hammered Exterior	Each	12/120



### STAINLESS STEEL FRY CUP WITH WIRE BASKET

- ◆ Great for serving, displays and more

ITEM	DESCRIPTION	UOM	CASE
SFCW-4S	4"Dia	Set	12/48



### WIRE FRY SERVERS

ITEM	DESCRIPTION	UOM	CASE
WBKH-5	1-Cone, Holds 2 Oz Ramekins	Each	12
WBKH-10	3-Cone	Each	4

## MINI SERVING BASKETS



FBM-544T



FBM-554S



FBM-32R



### MINI SERVING BASKETS

Add some contemporary style to a buffet setting or tabletop dining with these mini baskets, a novel way to present and serve side dishes or appetizers.

- ◆ 18/8 stainless steel
- ◆ Great for serving individual portions
- ◆ Dishwasher safe

ITEM	DESCRIPTION	UOM	CASE
FBM-32R	Round, 3-3/4"Dia x 2-7/8"H	Each	12/72
FBM-443S	Square, 4"L x 4"W x 3"H	Each	12/72
FBM-554S	Square, 5"L x 5"W x 4"H	Each	12/72
FBM-433T	Rectangular, 4"L x 3"W x 3"H	Each	12/72
FBM-544T	Rectangular, 5"L x 4"W x 4"H	Each	12/72

## TACO SERVICE



PTS-4



TCHS-23MN



TCHS-12



TCHS-34



TCHS-23



TCHS-45



### TACO SERVER

- ◆ Holds up to four (4) tacos
- ◆ Each pack comes with two (2) pieces

ITEM	DESCRIPTION	UOM	CASE
PTS-4	8"L x 5"W x 2-1/2"H	Set	1/16



### STAINLESS STEEL MINI TACO HOLDERS

- ◆ Brushed finish; 2"W x 1"H

ITEM	DESCRIPTION	UOM	CASE
TCHS-12MN	1-2 Slots, 2-3/8"L	Each	12/96
TCHS-23MN	2-3 Slots, 3-1/2"L	Each	12/72



### STAINLESS STEEL TACO HOLDERS

- ◆ Also useful for dressing hot dogs
- ◆ Can flip over to accommodate different quantities
- ◆ Brushed finish; 4"W x 2"H

ITEM	DESCRIPTION	UOM	CASE
TCHS-12	1-2 Slots, 5-5/8"L	Each	12/96
TCHS-23	2-3 Slots, 8-3/8"L	Each	12/72
TCHS-34	3-4 Slots, 11-3/8"L	Each	12/48
TCHS-45	4-5 Slots, 14"L	Each	12/36



**COPPER-PLATED MOSCOW MULE MUGS**

Whether serving its classic namesake drink or any refreshing cocktails, these rustic copper-plated mugs will keep drinks extra cold, making them great additions to an outdoor bar setting.

ITEM	DESCRIPTION	CAPACITY	UOM	CASE
CMM-2	Smooth, Mini, 4-Pcs/Set	2 Oz	Set	6/24
CMM-2H	Hammered, Mini 4-Pcs/Set	2 Oz	Set	6/24
CMM-20	Smooth	20 Oz	Each	36
CMM-20H	Hammered	20 Oz	Each	36

**MOSCOW MULE MUGS**



**STAINLESS STEEL MINT JULEP CUPS**

ITEM	DESCRIPTION	CAPACITY	UOM	CASE
DDSE-101S	3"Dia x 4-3/8"H	11 Oz	Each	12/72
DDSE-102S	3-3/8"Dia x 4-3/4"H	14 Oz	Each	12/72

**MINT JULEP CUPS**



**STAINLESS STEEL MINI MILK CANS**

Attractive and functional, mini milk cans elevate individual servings of sauce, dressing or creamer.

- ◆ Charming mini side handles

ITEM	DESCRIPTION	CAPACITY	UOM	CASE
DDSD-101S	2"Dia x 2"H	3 Oz	Each	12/144
DDSD-102S	2"Dia x 3-1/8"H	5 Oz	Each	12/72
DDSD-103S	3-1/8"Dia x 4"H	14 Oz	Each	12/36
DDSD-104S	3-1/8"Dia x 5"H	20 Oz	Each	12/36

**MINI MILK CANS & PAILS**



**STAINLESS STEEL HAMMERED MINI SERVING PAILS**

ITEM	DESCRIPTION	CAPACITY	UOM	CASE
DDSA-101S	3"Dia x 3-1/8"H	5 Oz	Each	12/72
DDSA-102S	3-1/2"Dia x 3-5/8"H	10 Oz	Each	12/72
DDSA-103S	5"Dia x 5"H	28 Oz	Each	12/48

**STAINLESS STEEL MINI SERVING PAILS**

ITEM	DESCRIPTION	CAPACITY	UOM	CASE
DDSA-104S	3"Dia x 3-1/8"H	5 Oz	Each	12/72
DDSA-105S	3-1/2"Dia x 3-5/8"H	10 Oz	Each	12/72
DDSA-106S	3-3/4"Dia x 3-3/4"H	12 Oz	Each	12/72
DDSA-107S	5"Dia x 5"H	28 Oz	Each	12/48



**STAINLESS STEEL VIETNAMESE COFFEE INFUSER**

Use this unique press with built-in filter to brew single-serve coffee that's smooth and strong every time.

- ◆ Set includes built-in filter, screw-down press, cover and 3-3/4" wide saucer

ITEM	DESCRIPTION	UOM	CASE
CFI-4	3-3/4"Dia x 2-1/2"H	Each	12/144

**COFFEE PRESSES**



**FRENCH PRESS**

- ◆ Stainless steel frame with polypropylene handle
- ◆ Can also be used with loose leaf teas
- ◆ Glass carafe approximately 4 cup capacity

ITEM	DESCRIPTION	CAPACITY	UOM	CASE
FPCM-33	3-3/4"Dia x 9-1/4"H	33 Oz	Each	1/12

## SERVING TRAYS



DDSH-102S



DDSI-102S



DDSI-101S



## STAINLESS STEEL MINI SERVING PLATTERS

ITEM	DESCRIPTION	UOM	CASE
DDSH-101S	6-5/8"L x 4-1/4"W	Each	12/72
DDSH-102S	8-1/2"L x 5-1/4"W	Each	12/72



## STAINLESS STEEL LONG SERVING TRAYS

ITEM	DESCRIPTION	UOM	CASE
DDSI-101S	14-1/8"L x 3-1/2"W	Each	12/48
DDSI-102S	14-1/8"L x 7-1/2"W	Each	12/24

## WOODEN FRENCH BREAD BOARD



### WOODEN FRENCH BREAD BOARD

*Perfect for serving fresh baked bread and hors d'oeuvres. Comfortable rounded serving handle built-in.*

- ◆ Reversible design made of solid birch wood
- ◆ Hand wash recommended



WCB-225

ITEM	DESCRIPTION	UOM	CASE
WCB-225	22-1/2"L x 5-1/2"W x 3/4"H	Each	12



## SERVING BOARDS



### MARBLE & WOOD SERVING BOARDS

*Add a rustic feel to any setting from buffets to sit-down dining. Ideal for serving cheeses, charcuterie, and other appetizers and desserts.*

- ◆ The balance of white marble and acacia wood is perfect in both sophisticated and rustic settings
- ◆ Elegantly serve cheese plates, charcuterie and other hors d'oeuvres
- ◆ The cool surface is ideal for serving cheeses & fruits
- ◆ Hand wash only



SBMW-117  
9" X 7", 2-1/2" HANDLE



SBMW-156  
11-1/2" X 6", 4-3/8" HANDLE



SBMW-157  
10-3/4" X 7", 4-1/2" HANDLE

ITEM	DESCRIPTION	UOM	CASE
SBMW-117	11-1/4" Overall Length	Each	6
SBMW-156	15-3/4" Overall Length	Each	6
SBMW-157	15" Overall Length	Each	6



- ◆ Professional grade, ideal for high-end kitchens or for white linen tabletops
- ◆ Premium quality beechwood
- ◆ Durable carbon steel grinder for clean, sharp cuts
- ◆ Long-lasting stainless steel internal mechanisms

## MAESTRO GOURMET PEPPERMILLS



WPM-6CD WPM-8CD WPM-10CD WPM-12CD



Durable carbon steel grinder for clean, sharp cuts



WPM-6K WPM-8K

### MAESTRO MODERN

- ◆ Beautiful clean lines for upscale modern presentation

ITEM	DESCRIPTION	UOM	CASE
WPM-6CD	6"H	Each	1/48
WPM-8CD	8"H	Each	1/36
WPM-10CD	10"H	Each	1/24
WPM-12CD	12"H	Each	1/24

### MAESTRO REPLACEMENT KNOBS

ITEM	DESCRIPTION	UOM	CASE
WPM-6K	Knob for 6" Peppermills	Each	1/48
WPM-8K	Knob for 8" Peppermills	Each	1/48

### WOODEN PEPPERMILLS

- ◆ Rubberwood with zinc alloy grinder

ITEM	DESCRIPTION	UOM	CASE
WPM-08	8"H	Each	1/36
WPM-10	10"H	Each	1/24
WPM-12	12"H	Each	1/24
WPM-18	18"H	Each	1/12

### SALT & PEPPER



WPM-08 WPM-10 WPM-12 WPM-18

### SALT SHAKER & PEPPER GRINDER SET

- ◆ Rubberwood black matte finish
- ◆ 2-1/4" Dia x 6" H

ITEM	DESCRIPTION	UOM	CASE
SP-612	Salt & Pepper, 2-Pcs/Set	Set	1/24
SP-624	Peppermills, 2-Pcs/Set	Set	1/24



SP-612 SALT & PEPPER

SP-624 2 PEPPERMILLS



WPMP-6

### ACRYLIC PEPPERMILL/SALT SHAKER

ITEM	DESCRIPTION	UOM	CASE
WPMP-6	6"H	Each	1/72

## PLATTER SERVERS



### CAST IRON FAJITA/STEAK SERVERS

- ◆ Improved plywood underliner resists splitting, chipping or cracking under the high-heat cast iron pan
- ◆ Cast iron servers are oven safe

ITEM	DESCRIPTION	UOM	CASE
FS-2	Fajita Server (5-3/16"L Built-in Handle) & Wood Underliner, 2-Pc Set	Set	1/12
FS-2-UL	Replacement Wood Underliner for FS-2 (No Retail Pkg)	Each	12
ISP-3	Steak Platter with 5-1/4"L Gripper Handle & Wood Underliner, 3-Pc Set	Set	1/12
ISP-3-UL	Replacement Wood Underliner for ISP-3 (No Retail Pkg)	Each	12

### ALUMINUM SIZZLING PLATTERS

- ◆ Aluminum platters are oven safe
- ◆ Wood underliner improved with layering construction to resist cracking under hot platter
- ◆ Platters and underliners sold separately

ITEM	DESCRIPTION	UOM	CASE
APL-10	10" Platter	Each	12/48
APL-10UL	Wood Underliner for APL-10	Each	12
APL-11	11" Platter	Each	12/48
APL-11UL	Wood Underliner for APL-11	Each	12
APL-12	12" Platter	Each	12/36
APL-12UL	Wood Underliner for APL-12	Each	12

### STAINLESS STEEL SIZZLING PLATTERS

- ◆ Stainless steel platters are oven safe
- ◆ Platters and underliners sold separately, and as sets

ITEM	DESCRIPTION	UOM	CASE
SIZ-11ST	11" Platter & Underliner Set	Set	12
SIZ-11	11" Oval Platter, S/S	Each	12/60
SWU-11	Underliner for SIZ-11	Each	12/36
SIZ-11BST	11" x 7" Platter & Underliner Set	Set	12
SIZ-11B	11" x 7" Rectangular Platter, S/S	Each	12/60
SWU-11B	Underliner for SIZ-11B	Each	12/36

## OVAL PLATTERS



### STAINLESS STEEL OVAL PLATTERS

ITEM	DESCRIPTION	UOM	CASE
OPL-12	12" x 8-5/8"	Each	10/60
OPL-14	14" x 8-3/4"	Each	10/60
OPL-16	16" x 10-1/4"	Each	10/40
OPL-18	18" x 11-1/2"	Each	10/30
OPL-20	20" x 13-3/4"	Each	10/20
OPL-22	21-3/4" x 14-1/2"	Each	12

## AU GRATIN DISHES



### AU GRATIN DISHES

- ◆ Stainless steel

ITEM	DESCRIPTION	UOM	CASE
ADO-8	8 Oz	Each	12/120
ADO-12	12 Oz	Each	12/144
ADO-15	15 Oz	Each	12/120
ADO-20	20 Oz	Each	12/72

### TORTILLA PRESSES

- ◆ Traditional press with excellent leverage
- ◆ Integrated handle allows for easy open and removal of corn/flour tortillas
- ◆ Great for making burritos, enchiladas and quesadillas

ITEM	DESCRIPTION	WEIGHT	UOM	CASE
TPC-8A	8"Dia, Aluminum, Non-Stick	1.52Lbs	Each	6/12
TPC-8C	8"Dia, Cast Iron	7.94Lbs	Each	1/4



### TORTILLA SERVICE



TPC-8A **PFOA FREE**



### TORTILLA WARMERS

- ◆ Lid features an easy-grip recessed handle and interlocks with base to seal in heat
- ◆ Stackable to transport several at once, or compact organized storage until ready to use
- ◆ Serve tortillas warm and fresh, ready for wrapping

ITEM	DESCRIPTION	CAPACITY	UOM	CASE
PTW-7K	7-1/2" Dia x 1-7/8"H	8 Tortillas	Each	12
PTW-8	8-1/2" Dia x 2-5/8"H	16 Tortillas	Each	12



**NEW**  
AVAILABLE IN JULY 2020

PTW-7K **NSF**



PTW-8 **BPA FREE**

Enhance South-of-the-Border dishes with our collection of Mexican-themed Molcajete salsa bowls and plate. These rustic traditional-style servers are break-resistant, made of BPA-free polypropylene and dishwasher safe.

### MOLCAJETE SALSA BOWLS

- ◆ BPA-free

ITEM	DESCRIPTION	UOM	CASE
PMSB-4	4 Oz, 4-Pcs/Pk	Pack	24
PMSB-10	10 Oz, 4-Pcs/Pk	Pack	12
PMSB-56	56 Oz	Each	1/16

### SALSA & DIP SERVICE



PMSB-56

PMSB-10

PMSB-SERIES

**NSF**  
**BPA FREE**

### MOLCAJETE SALSA PLATE

- ◆ BPA-free

ITEM	DESCRIPTION	UOM	CASE
PMP-12	12 Oz, 2-Pcs/Pk	Set	1/16



PMP-12

**BPA FREE**

## CONDIMENT HOLDERS

**NEW**



WH-3K  
Use with G-104



WBKH-6SB



WBKH-6R



WBKH-7R



### BLACK WIRE CADDIES

ITEM	DESCRIPTION	UOM	CASE
WH-3K	Rectangle, Fits 6 Oz Cruets	Each	12/48
WBKH-6SB	Flat Back, 8-1/4" x 6 1/4" x 9"H	Each	12
WBKH-6R	Round, 6-1/4"Dia x 9"H	Each	24
WBKH-7R	Round, 7-1/2"Dia x 9"H	Each	12



WH-1  
USE WITH PPH-SERIES,  
G-110, G-111



WH-2



### CHROME-PLATED HOLDERS

ITEM	DESCRIPTION	UOM	CASE
G-104S	Two 6 Oz Square Bottle Set w/Lids & Chrome-Plated Rack	Set	12
WH-1	Salt/Pepper Shakers & Sugar Packet Holder Rack (No Retail Pkg)	Each	12/48
WH-2	Sugar Packet Rack	Each	12/48
WH-3	Chrome-Plated Rack Holds 6 Oz Cruets (No Retail Pkg)	Each	12/48
WH-4	3-Ring Condiment Jar Rack	Each	12/48
WH-5	Rack Holds Two 6 Oz Sq Cruets	Each	12/72
WH-7	Salt/Pepper Shakers & Sugar Packets Rack	Each	12/72
WH-9	4-Ring Condiment Jar Rack	Each	12/48



WH-9  
USE WITH CJ-7P, CJ-7G  
Sold separately



WH-4  
USE WITH CJ-7P, CJ-7G  
Sold separately



G-104S  
USE WITH WH-3  
AND (2) G-104



WH-3  
USE WITH G-104



WH-5  
USE WITH  
G-104



WH-7  
USE WITH G-109

### OIL & VINEGAR CRUETS

*Also a great way to bottle and/or serve sauces and light syrups.*



ITEM	DESCRIPTION	UOM	CASE
GOB-8S	2 Square 8 Oz Oil Bottles w/Lid & Chrome-Plated Rack	Set	12
GOB-16S	2 Square 16 Oz Oil Bottles w/Lid & Chrome-Plated Rack	Set	12
GOB-8	Square 8 Oz Oil Bottle w/Lid	Each	24
GOB-16	Square 16 Oz Oil Bottle w/Lid	Each	12
WH-8	Chrome Plated Rack, Fits GOB-8	Each	48
WH-16	Chrome Plated Rack, Fits GOB-16	Each	24



GOB-16S



GOB-8



GOB-16



WH-16

## GLASS SHAKERS



DESCRIPTION	SIZE	UOM	WHOLESALE BOX PACKAGING		REPLACEMENT TOPS FOR SHAKERS				
			ITEM	CASE	ITEM	DESCRIPTION	CASE		
Square Shakers, S/S Tops	1/2 Oz	Doz	G-100	1/48	G-100C	For G-100 / G-110	24/144		
Square Shakers, Brass Tops	1/2 Oz	Doz	G-101	1/48	G-101C	For G-101 / G-301 / G-111	24/144		
Sugar Pourers, Flap Tops	12 Oz	Doz	G-102	1/4	G-102C	For G-102 / G-302	4/48		
Sugar Pourers, Perf Tops	12 Oz	Doz	G-103	1/4	G-103C	For G-103	4/48		
Oil/Vinegar Cruets	6 Oz	Doz	G-104	1/6	G-104C	For G-104	18/108		
Paneled Shakers, Mushroom Tops	1 Oz	Doz	G-105	1/10	G-105C	For G-105	24/120		
Paneled Shakers, Mushroom Tops	2 Oz	Doz	G-106	1/10	G-106C	For G-106	24/120		
Cheese Shakers, Perf Tops	6 Oz	Doz	G-107	1/5	G-107C	For G-107	5/90		
Cheese Shakers, Slotted Tops	6 Oz	Doz	G-108	1/5	G-108C	For G-108	5/90		
Square Shakers, S/S Mushroom Tops	2 Oz	Doz	G-109	1/12	G-109C	For G-109	12/96		
Tower Shakers, S/S Tops	1 Oz	Doz	G-110	1/12					
Tower Shakers, Brass Tops	1 Oz	Doz	G-111	1/12					
Paneled Shakers, Mushroom Tops	3 Oz	Doz	G-117	1/12					
Classic Shakers, S/S Flat Tops	2 Oz	Doz	G-118	1/12					
Syrup Dispensers	6 Oz	Doz	G-115	1/6					
Syrup Dispensers	14 Oz	Doz	G-116	1/4					

### SALT & PEPPER REFILLER JUGS

- ◆ Spring loaded spout allows for quick refill of salt and pepper shakers

ITEM	DESCRIPTION	UOM	CASE
PR-05P	1/2 Gal Pepper Refiller	Each	24
PR-05S	1/2 Gal Salt Refiller	Each	24

### SALT & PEPPER REFILLERS



PR-05S

PR-05P

## CONDIMENT DISPENSER



**IMPROVED**

PKTS-2D

**BPA FREE**

PKTS-SERIES

## CONDIMENT DISPENSER

*Ideal for busy bars, food stands, convenience stores or fast-food service. Removable plastic fountain jars allow for easy cleaning and refilling.*

- ◆ Durable 18/8 stainless steel, heavy duty pump
- ◆ Two (2) 3-1/2 Qt plastic fountain jars included (7 Qt total)
- ◆ Each pump dispenses between 1 oz and 1-1/4 oz portions, depending on thickness of condiments
- ◆ Overall dimensions: 11"L x 8-3/4"W x 16"H (with pump)
- ◆ Assembly required

ITEM	DESCRIPTION	UOM	CASE
PKTS-2D	Condiment Dispenser with 2 Standard Pumps	Set	1/2
PKTS-PT01	Individual Pump with Lid	Each	1
PKTS-PT02	Replacement Plastic Fountain Jar	Each	1
PKTS-PT03	Stainless Steel Casing	Each	1

## SAUCE & DESSERT CUPS



RFM-SERIES



Fluted Ramekins



RP-SERIES



Plain Ramekins



BLACK

WHITE

BONE

**NSF**

MELAMINE RAMEKINS



## MELAMINE RAMEKINS

*With a variety of colors and sizes available, the break-resistant melamine ramekin cups are ideal for high volume, fast-paced foodservice environments.*

- ◆ NSF listed

ITEM	DESCRIPTION	SIZE	COLOR	UOM	CASE
RFM-1K	Fluted	1-1/2 Oz	Black	Doz	1/8
RFM-1W	Fluted	1-1/2 Oz	White	Doz	1/8
RFM-1B	Fluted	1-1/2 Oz	Bone	Doz	1/8
RFM-2K	Fluted	2 Oz	Black	Doz	1/8
RFM-2W	Fluted	2 Oz	White	Doz	1/8
RFM-2B	Fluted	2 Oz	Bone	Doz	1/8
RFM-3K	Fluted	3 Oz	Black	Doz	1/8
RFM-3W	Fluted	3 Oz	White	Doz	1/8
RFM-3B	Fluted	3 Oz	Bone	Doz	1/8
RFM-4K	Fluted	4 Oz	Black	Doz	1/8
RFM-4W	Fluted	4 Oz	White	Doz	1/8
RFM-4B	Fluted	4 Oz	Bone	Doz	1/8
RP-1K	Plain	1-1/2 Oz	Black	Doz	1/8
RP-1W	Plain	1-1/2 Oz	White	Doz	1/8
RP-1B	Plain	1-1/2 Oz	Bone	Doz	1/8
RP-2K	Plain	2 Oz	Black	Doz	1/8
RP-2W	Plain	2 Oz	White	Doz	1/8
RP-2B	Plain	2 Oz	Bone	Doz	1/8
RP-3K	Plain	3 Oz	Black	Doz	1/8
RP-3W	Plain	3 Oz	White	Doz	1/8
RP-3B	Plain	3 Oz	Bone	Doz	1/8
RP-4K	Plain	4 Oz	Black	Doz	1/8
RP-4W	Plain	4 Oz	White	Doz	1/8
RP-4B	Plain	4 Oz	Bone	Doz	1/8
RP-6K	Plain	6 Oz	Black	Doz	1/8
RP-6W	Plain	6 Oz	White	Doz	1/8
RP-6B	Plain	6 Oz	Bone	Doz	1/8



SCP-15

SCP-25

SCP-40

## STAINLESS STEEL SAUCE CUPS

ITEM	DESCRIPTION	UOM	CASE
SCP-15	1-1/2 Oz	Doz	1/48
SCP-25	2-1/2 Oz	Doz	1/48
SCP-40	4 Oz	Doz	1/48

## SYRUP/CREAM PITCHER

- ◆ Durable SAN plastic
- ◆ BPA-free
- ◆ 24-pcs/pk

ITEM	DESCRIPTION	UOM	CASE
PSN-2	2 Oz Pitcher	Pack	6/12



## CLEAR ICE CREAM & BERRY DISH

- ◆ BPA-free

ITEM	DESCRIPTION	UOM	CASE
ICC-5C	SAN, 5 Oz	Doz	1/16

**NSF**

PSN-2

**BPA FREE**

**BPA FREE**

ICC-5C





### GRAVY BOATS

◆ Stainless steel

ITEM	DESCRIPTION	UOM	CASE
GBS-3	3 Oz	Each	12/72
GBS-5	5 Oz	Each	12/48
GBS-8	8 Oz	Each	12/36
GBS-10	10 Oz	Each	12/36

### CONDIMENT SERVICE



GBS-10

### SERVERS/CREAMERS

◆ Stainless steel

ITEM	DESCRIPTION	UOM	CASE
SCT-10	10 Oz w/Knob	Each	12/120
SCT-10F	10 Oz, Stackable Cover	Each	12/120



SCT-10F



SCT-10

### BELL CREAMERS

◆ Stainless steel

ITEM	DESCRIPTION	UOM	CASE
BCS-3	3 Oz	Each	12/144
BCS-5	5 Oz	Each	12/144
BCS-8	8 Oz	Each	12/144
BCS-10	10 Oz	Each	12/72



BCS-8



BCS-3

### SYRUP DISPENSERS & COLOR LIDS

- ◆ Stainless steel slide-on lid prevents dripping
- ◆ PE bottles and interchangeable PP Lids
- ◆ Ideal for batter, dressing, juice and more

ITEM	DESCRIPTION	UOM	CASE
PSUD-32	32 Oz	Each	12
PSUD-48	48 Oz	Each	12
PSUD-RLid	Lid, Red	Each	24/144
PSUD-TLid	Lid, Tan	Each	24/144
PSUD-WLid	Lid, White	Each	24/144



PSUD-48

**BPA FREE**



PSUD-32

**BPA FREE**



PSUD-TLID



PSUD-RLID

### STAINLESS STEEL SWEETENER PACKET HOLDERS

ITEM	DESCRIPTION	UOM	CASE
DDSG-101S	3-3/16"L x 2-5/8"W Tray	Each	12/144
DDSG-102S	1-3/4" Square Cup	Each	12/144
DDSG-103S	2"Dia Round Cup	Each	12/216
DDSG-301S	2"Dia Rnd & 2" Square Sugar Packet Holder Set	Each	12/60



DDSG-301S

### PLASTIC SWEETENER PACKET HOLDERS

- ◆ 3-1/2" L x 2-1/2" W x 2" H
- ◆ NSF listed

ITEM	DESCRIPTION	UOM	CASE
PPH-1C	Clear	Doz	1/6
PPH-1K	Black	Doz	1/6
PPH-1W	White	Doz	1/6



PPH-SERIES

**NSF**

## CONDIMENT SERVICE



SBR-30



T-710



SD-5



SBW-35



CJ-2C



CJ-PC



CJ-7P



CJ-7G



RS-4



### ROLL-TOP FOOTED SUGAR BOWL

- ◆ Stainless steel

ITEM	DESCRIPTION	UOM	CASE
SBR-30	20 Oz	Each	1/24

### HINGED LID SUGAR CAN

- ◆ Stainless steel
- ◆ Slotted, hinged lid

ITEM	DESCRIPTION	UOM	CASE
T-710	10 Oz	Each	1/72

### SHERBET FOOTED DISHES

- ◆ Stainless steel
- ◆ Paneled design with footed base

ITEM	DESCRIPTION	UOM	CASE
SD-3	3-1/2 Oz	Each	12/120
SD-5	5 Oz	Each	12/120

### BUTTER WARMER

- ◆ Set includes wire stand, stainless steel butter pan, glass votive holder and candle

ITEM	DESCRIPTION	UOM	CASE
SBW-35	4-Pc Set	Set	1/48

### CONDIMENT JARS & COVERS

- ◆ 7 oz capacity jars
- ◆ Covers can be used with either jar

ITEM	DESCRIPTION	UOM	CASE
CJ-7P	Clear Jar, Plastic	Doz	1/6
CJ-7G	Clear Jar, Glass	Doz	3
CJ-PC	Slotted Cover, Plastic	Doz	24
CJ-2C	Slotted Cover, S/S	Each	36/144

### RELISH SERVERS

- ◆ Stainless steel
- ◆ 8 oz capacity per cup



ITEM	DESCRIPTION	UOM	CASE
RS-3	3 Compartments	Set	1/24
RS-4	4 Compartments	Set	1/24

## SNAIL SERVICE



SND-6



SND-T6



SND-F7

### SNAIL SERVICE

- ◆ Stainless steel
- ◆ Neatly serve escargot

ITEM	DESCRIPTION	UOM	CASE
SND-6	Dish, 6 Wells	Each	12/144
SND-T6	Tongs	Each	12/120
SND-F7	Fork	Doz	1/50

## SEAFOOD TRAYS

Create an enticing tabletop spread with these trays in assorted sizes for displaying shrimp, seafood or tasty appetizers. The brushed aluminum construction retains cold and keeps foods at safe serving temperatures.

ITEM	DESCRIPTION	UOM	CASE
ASFT-12	12"Dia x 1-1/2"H	Each	12/36
ASFT-14	13-3/4"Dia x 1-1/2"H	Each	12/36
ASFT-16	15-3/4"Dia x 1-1/2"H	Each	12/24
ASFT-18	17-3/4"Dia x 1-1/2"H	Each	12/24
ASFT-20	19-3/4"Dia x 1-1/2"H	Each	12

## SEAFOOD TRAYS



ASFT-12

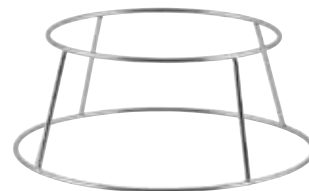

SFR-4



### CHROME-PLATED SEAFOOD TRAY RACKS

- ◆ Use with ASFT-series seafood trays to create appealing tabletop presentations
- ◆ Also perfect for elevating serving plates, bowls and platters, as well as holding pizza pans

ITEM	DESCRIPTION	UOM	CASE
SFR-4	7-3/8" Top Dia, 9-5/8" Bottom Dia x 4-3/8"H	Each	20
SFR-7	7-3/8" Top Dia, 9-5/8" Bottom Dia x 7"H	Each	20

## PEARL SHELL BOWLS

Made of light-weight ABS plastic, these shell bowls are ideal for displaying cold foods and salads.

ITEM	DESCRIPTION	UOM	CASE
PSBW-1W	20 Oz	Each	12/48
PSBW-5W	5 Qt	Each	6/12

## SALAD BOWLS



PSBW-1W

PSBW-5W

### PEBBLED SALAD BOWLS

- ◆ Made of durable polycarbonate, these clear pebbled bowls are perfect for salads, fruits, desserts and snacks
- ◆ NSF listed

ITEM	DESCRIPTION	UOM	CASE
PBB-6	6-3/4"	Each	96
PBB-8	8-3/4"	Each	48
PBB-10	10-3/4"	Each	24
PBB-12	12-3/4"	Each	24
PBB-15	15-3/4"	Each	12
PBB-18	18-3/4"	Each	12



PBB-10

PBB-SERIES 

### WOODEN SALAD BOWLS

- ◆ Hand wash only
- ◆ Also good for chips and snacks

ITEM	DESCRIPTION	UOM	CASE
WWB-5	5"	Each	12/288
WWB-6	6"	Each	12/288
WWB-8	8"	Each	12/144
WWB-10	10"	Each	12/96
WWB-12	12"	Each	12/72
WWB-14	14"	Each	12/36
WWB-16	16"	Each	12/24
WWB-18	18"	Each	12
WWB-20	20"	Each	12



WWB-SERIES



TABLETOP BASKETS



PWBN-94B



PWBK-88R



PWBN-9B



PWBN-9R



PWBN-9V



PWBN-16B



PWBK-SERIES



SOLID-CORD POLY WOVEN BASKETS

- ◆ Flexible with reinforced weaving on rim and base for added durability
- ◆ Easily stackable
- ◆ Dishwasher safe

ITEM	DESCRIPTION	SIZE	COLOR	UOM	CASE
PWBK-118T	Rectangular, 12-Pcs/Pk	11-1/2" x 8-1/2" x 3-1/2"	Black	Pack	1/2
PWBK-96V	Oval, 6-Pcs/Pk	9-1/4" x 6-1/4" x 3-1/4"	Black	Pack	1/12
PWBK-156V	Oval, 6-Pcs/Pk	15" x 6-1/2" x 3-1/4"	Black	Pack	1/6
PWBK-88R	Round, 12-Pcs/Pk	8-1/4" x 3-1/4"	Black	Pack	1/3
PWBN-88R	Round, 12-Pcs/Pkk	8-1/4" x 3-1/4"	Natural	Pack	1/3
PWBN-94B	Oval, 6-Pcs/Pk	9" x 4-1/2" x 3"	Natural	Pack	1/12

TAN POLY WOVEN BASKETS

ITEM	DESCRIPTION	SIZE	UOM	CASE
PWBN-9B	Long Oval	9" x 4-1/4" x 2"	Doz	1/12
PWBN-9R	Round	9" x 2-3/4"	Doz	1/12
PWBN-9V	Oval	9-1/2" x 6-1/2" x 2-3/4"	Doz	1/12

NATURAL WOVEN BASKETS

ITEM	DESCRIPTION	SIZE	UOM	CASE
PWBN-12B	Rectangle with Handles	12" x 8" x 3"	Each	12/96
PWBN-16B	Rectangle with Handles	16" x 11" x 3"	Each	12/48

BLACK/GOLD POLY WOVEN BASKETS

- ◆ Wire reinforced

ITEM	DESCRIPTION	SIZE	UOM	CASE
PWBK-8R	Round	8-1/4" x 2-1/4"	Doz	1/12
PWBK-9B	Long Oval	8-3/4" x 3-7/8" x 2"	Doz	1/12
PWBK-9V	Oval	9" x 7" x 2-3/4"	Doz	1/12



### BREAD BASKETS

ITEM	DESCRIPTION	SIZE	UOM	CASE
WBKG-9	Rectangular	9" x 5-7/8" x 3"	Each	24
WBKG-8R	Round	8"	Each	48
WBKG-10O	Oval	10" x 6-1/2" x 3"	Each	24
WBKG-10R	Round	10"	Each	12
WBKG-15	Long Oval	15" x 6-1/4" x 3"	Each	12

### BLACK WIRE SERVING BASKETS



WBKG-9



WBKG-10O



WBKG-15



WBKG-10R



### PLASTIC OVAL PLATTERS

- ◆ Sturdy BPA-free poly plastic
- ◆ Microwave and heat lamp safe up to 150°F (65°C)
- ◆ Great for bread, appetizers, sandwiches and fries
- ◆ Dishwasher safe

ITEM	DESCRIPTION (L X W X H)	COLOR	UOM	CASE
PLB-G	10-3/4" x 7-1/4" x 1-1/2"	Green	Doz	12
PLB-K	10-3/4" x 7-1/4" x 1-1/2"	Black	Doz	12
PLB-R	10-3/4" x 7-1/4" x 1-1/2"	Red	Doz	12
PLB-Y	10-3/4" x 7-1/4" x 1-1/2"	Yellow	Doz	12

### FAST FOOD BASKETS



PLB-SERIES

NSF

BPA FREE



### PREMIUM PLASTIC OVAL BASKETS

- ◆ Sturdy BPA-free poly plastic
- ◆ Microwave and heat lamp safe up to 150°F (65°C)
- ◆ Great for fast dining establishments
- ◆ Choice of five (5) colors
- ◆ Dishwasher safe

ITEM	DESCRIPTION (L X W X H)	COLOR	UOM	CASE
POB-G	10-1/4" x 6-3/4" x 2"	Green	Doz	12
POB-K	10-1/4" x 6-3/4" x 2"	Black	Doz	12
POB-R	10-1/4" x 6-3/4" x 2"	Red	Doz	12
POB-Y	10-1/4" x 6-3/4" x 2"	Yellow	Doz	12
PFB-10B	9-1/2" x 5" x 2"	Brown	Doz	3
PFB-10G	9-1/2" x 5" x 2"	Green	Doz	3
PFB-10R	9-1/2" x 5" x 2"	Red	Doz	3



POB-SERIES

NSF

BPA FREE



PFB-SERIES

BPA FREE



## MENU COVERS



Full size menu cover styles available in 3 colors

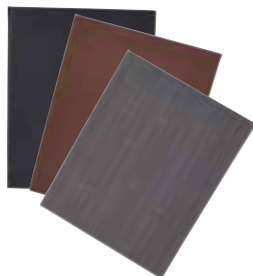

Chic leatherette menu covers provide an elegant yet durable display for full-service or fast casual restaurants alike. The refined double-sided stitched menu covers offer the look of a customized menu without the customization wait times - a timeless style in a full collection to complement any décor.

- ◆ Features secure interior picture corners
- ◆ Available for both letter and legal size pages
- ◆ Three neutral color choices and patterns
- ◆ Most common sizes and page configurations available



LMS-814GY  
Legal size

LMS-811GY  
Letter size

LMS-414BK  
Bar size



Picture corners

### SINGLE-VIEW MENU COVERS

- ◆ Great for lunch or tapas menus, drink specials and desserts
- ◆ LMS-414BK fits 4-1/2" x 14" paper
- ◆ LMS-811 series fits 8-1/2" x 11" letter size paper
- ◆ LMS-814 series fits 8-1/2" x 14" legal size paper

ITEM	DESCRIPTION	COLOR	UOM	CASE
LMS-811BK	Letter Size	Black	Each	50
LMS-811BN	Letter Size	Brown	Each	50
LMS-811GY	Letter Size	Gray	Each	50
LMS-814BK	Legal Size	Black	Each	50
LMS-814BN	Legal Size	Brown	Each	50
LMS-814GY	Legal Size	Gray	Each	50
LMS-414BK	Bar Size	Black	Each	50

### TWO-VIEW MENU COVERS

- ◆ Perfect for most upscale dinner menus highlighting the finest of chef's creations
- ◆ LMD-811 series fits 8-1/2" x 11" letter size paper
- ◆ LMD-814 series fits 8-1/2" x 14" legal size paper

ITEM	DESCRIPTION	COLOR	UOM	CASE
LMD-811BK	Letter Size	Black	Each	30
LMD-811BN	Letter Size	Brown	Each	30
LMD-811GY	Letter Size	Gray	Each	30
LMD-814BK	Legal Size	Black	Each	30
LMD-814BN	Legal Size	Brown	Each	30
LMD-814GY	Legal Size	Gray	Each	30



LMD-814BK  
Two-view  
Legal size

### FOUR-VIEW MENU COVERS

- ◆ Ideal for most casual restaurant establishments with an extensive variety of menu items
- ◆ LMF-811 series fits 8-1/2" x 11" letter size paper
- ◆ LMF-814 series fits 8-1/2" x 14" legal size paper

ITEM	DESCRIPTION	COLOR	UOM	CASE
LMF-811BK	Letter Size	Black	Each	30
LMF-811BN	Letter Size	Brown	Each	30
LMF-811GY	Letter Size	Gray	Each	30
LMF-814BK	Legal Size	Black	Each	30
LMF-814BN	Legal Size	Brown	Each	30
LMF-814GY	Legal Size	Gray	Each	30



LMF-814GY  
Four-view  
Legal size

### MENU TENTS

- ◆ Highlight specials or drinks with either our dual or 3-sided tent menus
- ◆ Easily change out promotional menus on these durable tabletop holders
- ◆ 5" x 7" paper fits in menu tents

ITEM	DESCRIPTION	UOM	CASE
LMTD-57BK	Dual-View	Each	50
LMTT-57BK	Triple-View	Each	50



LMTD-57BK



LMTT-57BK

# MENU COVERS & HOLDERS

The edgings on all Winco® menu covers are double stitched to hold up to the wear and tear of constant, daily handling.

ALL CLEAR PAGES

## SINGLE POCKET MENU COVERS

- ◆ PMC-5 series fits 5-1/2" x 8" paper
- ◆ PMC-9 series fits 8-1/2" x 11" paper
- ◆ PMC-14 series fits 8-1/2" x 14" paper

ITEM	DESCRIPTION	UOM	CASE
PMC-5K	Black 6-3/8" x 9-3/8"	Each	25/200
PMC-5U	Burgundy 6-3/8" x 9-3/8"	Each	25/200
PMC-9B	Blue 9-3/8" x 12-1/8"	Each	25/200
PMC-9K	Black 9-3/8" x 12-1/8"	Each	25/200
PMC-9R	Red 9-3/8" x 12-1/8"	Each	25/200
PMC-9U	Burgundy 9-3/8" x 12-1/8"	Each	25/200
PMC-9G	Green 9-3/8" x 12-1/8"	Each	25/200
PMC-14K	Black 9-3/8" x 14-7/8"	Each	25/100
PMC-14U	Burgundy 9-3/8" x 14-7/8"	Each	25/100



PMC-SERIES

## BOOK-FOLD DOUBLE PANEL MENU COVERS

- ◆ PMCD-9 series fits 8-1/2" x 11" paper
- ◆ PMCD-14 series fits 8-1/2" x 14" paper

ITEM	DESCRIPTION	UOM	CASE
PMCD-9B	Blue 9-3/8" x 12-1/8"	Each	25/100
PMCD-9K	Black 9-3/8" x 12-1/8"	Each	25/100
PMCD-9R	Red 9-3/8" x 12-1/8"	Each	25/100
PMCD-9U	Burgundy 9-3/8" x 12-1/8"	Each	25/100
PMCD-9G	Green 9-3/8" x 12-1/8"	Each	25/100
PMCD-14K	Black 9-9/16" x 15"	Each	25/100
PMCD-14U	Burgundy 9-9/16" x 15"	Each	25/100



PMCD-9K

## TRI-FOLD TRIPLE PANEL MENU COVERS

- ◆ PMCT-9 fits 8-1/2" x 11" paper

ITEM	DESCRIPTION	UOM	CASE
PMCT-9B	Blue 9-1/2" x 12-1/8"	Each	25/50
PMCT-9K	Black 9-1/2" x 12-1/8"	Each	25/50
PMCT-9R	Red 9-1/2" x 12-1/8"	Each	25/50
PMCT-9G	Green 9-1/2" x 12-1/8"	Each	25/50
PMCT-9U	Burgundy 9-1/2" x 12-1/8"	Each	25/50



PMCT-9K

## FOUR POCKET BLACK MENU COVER

- ◆ PMCF-9 fits 8-1/2" x 11" paper

ITEM	DESCRIPTION	UOM	CASE
PMCF-9K	9-5/8" x 12-1/8"	Each	25/50



PMCF-9K

## DOUBLE-SIDED CLEAR ACRYLIC MENU STANDS

- ◆ 2.0mm thickness

ITEM	DESCRIPTION	UOM	CASE
ATCH-46	4" x 6"	Each	12/36
ATCH-53	5-1/2" x 3-1/2"	Each	12/48
ATCH-57	5" x 7"	Each	12/36
ATCH-811	8" x 11"	Each	12/24



ATCH-811

## SIGN CLIPS & HOLDERS



TBH-12



TBN-SERIES



MH-1



MH-2



MH-2C



TCD-2



TCD-3C



TCD-3S



TCD-4D



TCD-4S

## TABLE NUMBER HOLDERS

◆ Mirror finish chrome-plated steel

ITEM	DESCRIPTION	UOM	CASE
TBH-8	8"	Each	12/120
TBH-12	12"	Each	12/120
TBH-15	15"	Each	12/120
TBH-18	18"	Each	12/120

## PLASTIC TABLE NUMBERS

◆ Numbers printed on both sides

◆ Measures 4" x 3-3/4"

ITEM	DESCRIPTION	UOM	CASE
TBN-25	Numbers 1-25	Set	1/200
TBN-50	Numbers 1-50	Set	1/100
TBN-100	Numbers 1-100	Set	1/50

## MENU HOLDER CLIPS

ITEM	DESCRIPTION	UOM	CASE
MH-1	Harp Clip, Heavy-Cast Base, 1"L x 1"W x 1-1/2"H	Doz	10/60
MH-2	Ring-Type, 2-1/2" x 2-1/3"	Doz	2/20
MH-2C	Clip, 2-1/2" x 2-1/2"	Doz	1/40



## TABLE SIGN HOLDERS

*Stylish and discreet, these table sign holders are perfect for buffet and table seating.*

ITEM	DESCRIPTION	UOM	CASE
TCD-2	Table Sign Holder, Cast Aluminum, 2-Pcs/Pk	Pack	24/240
TCD-3C	Table Sign Clip, "C" Base, 6-Pcs/Pk	Pack	4/96
TCD-3S	Table Sign Clip, "S" Base, 6-Pcs/Pk	Pack	4/96
TCD-4D	Table Sign Clip, Double Sided Clips, Flexible, 6-Pcs/Pk	Pack	48/192
TCD-4S	Table Sign Clip, Acrylic Square Base, 6-Pcs/Pk	Pack	4/48



## WINE SERVICE

### 4 QT WINE BUCKETS & STAND

- ◆ Stainless steel mirror finish

ITEM	DESCRIPTION	SIZE	UOM	CASE
WB-4	4 Qt Wine Bucket, (No Retail Pkg)	7-1/2" Dia x 8" H	Each	6/24
WB-4HV	4 Qt Deluxe Wine Bucket	8" Dia x 10" H	Each	1/12
WB-29S	Pipe Style Stand for WB-4 & WB-4HV	28-1/2" H	Each	1/6



WB-4



WB-4HV



WB-29S

### 8 QT WINE BUCKET & STANDS

- ◆ Stainless steel mirror finish

ITEM	DESCRIPTION	UOM	CASE
WB-8	8 Qt Wine Bucket	Each	6/24
WB-8S	Stand* for WB-8	Each	1/12
WB-12FS	Folding Stand for WB-8	Each	1/6

\*Assembly required

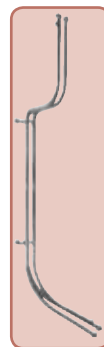

WB-12FS  
Folded



WB-12FS  
OPEN



WB-8 & WB-8S

### STAINLESS STEEL DOUBLE WALL WINE COASTERS

- ◆ Great space saving alternative to wine buckets
- ◆ Can also be used to display light snacks, hors d'oeuvres or desserts on tabletops
- ◆ Satin finish, smooth or hammered
- ◆ Fits 3-3/4" diameter wine bottles

ITEM	DESCRIPTION	SIZE	UOM	CASE
DWCC-5	Smooth Finish	4-5/8" Dia x 2-5/8"H	Each	12
DWCC-5H	Hammered Finish	4-5/8" Dia x 2-5/8"H	Each	12



DWCC-5H



DWCC-5

### WINE COOLERS

ITEM	DESCRIPTION	SIZE	UOM	CASE
WC-60	Double Wall Hourglass, Mirror S/S	6" Dia x 7" H	Each	1/12
WC-7M	Marble, White	4 1/2" Dia x 7" H	Each	1/6
WC-5	Double Wall, Satin S/S (No Retail Pkg)	4 1/2" Dia x 7-3/4" H	Each	6/24
WC-4A	Acrylic, Clear	4 1/2" Dia x 9 1/4" H	Each	1/12



WC-60



WC-7M



WC-5



WC-4A

## NON-SLIP SERVING TRAYS



TFG-16N

TFG-2622K

**NSF** TFG FIBERGLASS SERIES



## DELUXE FIBERGLASS TRAYS

- ◆ High durability fiberglass tray with self-molded peel-resistant non-slip surface
- ◆ Easy to wash by hand, however not recommended to leave soaking in hot water
- ◆ NSF listed

ITEM	DESCRIPTION	SIZE	COLOR	UOM	CASE
TFG-11K	Round	11"	Black	Each	1/12
TFG-11N	Round	11"	Brown	Each	1/12
TFG-14K	Round	14"	Black	Each	1/12
TFG-14N	Round	14"	Brown	Each	1/12
TFG-16K	Round	16"	Black	Each	1/12
TFG-16N	Round	16"	Brown	Each	1/12
TFG-2622K	Oval	26"x 22"	Black	Each	1/6
TFG-2622N	Oval	26"x 22"	Brown	Each	1/6



TRH-16

TRH-2722K

**NSF** TRH PLASTIC SERIES

## EASY-HOLD RUBBER-LINED PLASTIC TRAYS

- ◆ NSF listed

ITEM	DESCRIPTION	SIZE	COLOR	UOM	CASE
TRH-11	Round	11"	Brown	Each	12
TRH-11K	Round	11"	Black	Each	12
TRH-14	Round	14"	Brown	Each	12
TRH-14K	Round	14"	Black	Each	12
TRH-16	Round	16"	Brown	Each	12
TRH-16K	Round	16"	Black	Each	12
TRH-1418	Rectangular	18" x 14"	Brown	Each	12
TRH-1418K	Rectangular	18" x 14"	Black	Each	12
TRH-2722	Oval	27" x 22"	Brown	Each	1/6
TRH-2722K	Oval	27" x 22"	Black	Each	1/6



TCK-16

## PLASTIC CORK-LINED TRAYS

ITEM	DESCRIPTION	SIZE	UOM	CASE
TCK-14	Round	14"	Each	12/48
TCK-16	Round	16"	Each	12/36
TCK-14CK	Replacement Cork for TCK-14		Each	50/350
TCK-16CK	Replacement Cork for TCK-16		Each	50/350

## TRAY STANDS



TSY-1A

TR-33W

TR-34W

## TRAY STANDS

ITEM	DESCRIPTION	SIZE	UOM	CASE
TSY-1A	Chrome Steel	31"	Each	6
TR-33W	Rubberwood, Walnut	32"	Each	1
TR-34W	Rubberwood, Mahogany	32"	Each	1

### SERVING TRAYS

Made of highly polished stainless steel, these round trays feature a whimsical swirl surface pattern, adding a modern flair to even the most traditional drink presentations.

ITEM	DESCRIPTION	SIZE	UOM	CASE
STRS-12	Round	12"	Each	12/48
STRS-14	Round	14"	Each	12/24
STRS-16	Round	16"	Each	12/24



STRS-14

### CHROME SERVING TRAYS

The classic gadroon edge and traditional engraving of these chrome-plated trays are perfect for tea and coffee service, as well as pastries, appetizers and desserts.

- ◆ Available in a variety of shapes and sizes
- ◆ Not recommended for prolonged use with meat or acidic ingredients
- ◆ Hand wash only

ITEM	DESCRIPTION	SIZE	UOM	CASE
CMT-1912	Rectangular w/Handles	19-1/2" x 12-1/2"	Each	12/24
CMT-1217	Octagonal	17" x 12-1/2"	Each	12/24
CMT-1420	Octagonal	20" x 14"	Each	12/24
CMT-1812	Rectangular	18" x 12-1/2"	Each	12/24
CMT-2014	Rectangular	20" x 14"	Each	12/24
CMT-1014	Oval	14-3/4" x 10-1/2"	Each	12/24
CMT-1318	Oval	18-3/4" x 13"	Each	12/24
CMT-14	Round	14"	Each	12/24

### CHROME SERVING TRAYS



CMT-1912



CMT-1420



CMT-14



CMT-1318



CMT-2014

### PLATTERS

- ◆ Stainless steel

ITEM	DESCRIPTION	SIZE	UOM	CASE
OPL-12	Oval	12" x 8-5/8"	Each	10/60
OPL-14	Oval	14" x 8-3/4"	Each	10/60
OPL-16	Oval	16" x 10-1/4"	Each	10/40
OPL-18	Oval	18" x 11-1/2"	Each	10/30
OPL-20	Oval	20" x 13-3/4"	Each	10/20
OPL-22	Oval	21-3/4" x 14-1/2"	Each	12

### OVAL PLATTERS



OPL-14

## DINING TRAYS



Reinforced bottom



**3** POPULAR SIZES  
**7** GREAT COLORS



**NSF** **BPA FREE** FFT-SERIES



**NSF** FGT-1520W

Reinforced to prevent warping



SEE PAGE 238 FOR MORE SHEET PANS



ALXP-1013

## HIGH QUALITY PLASTIC CAFETERIA TRAYS

- ◆ Resists warping with frequent use
- ◆ NSF listed

ITEM	DESCRIPTION	COLOR	UOM	CASE
FFT-1014B	10" x 14"	Brown	Each	12/48
FFT-1014E	10" x 14"	Grey	Each	12/48
FFT-1014G	10" x 14"	Green	Each	12/48
FFT-1014K	10" x 14"	Black	Each	12/48
FFT-1014O	10" x 14"	Orange	Each	12/48
FFT-1014R	10" x 14"	Red	Each	12/48
FFT-1014U	10" x 14"	Burgundy	Each	12/48
FFT-1216B	12" x 16"	Brown	Each	12/48
FFT-1216E	12" x 16"	Grey	Each	12/48
FFT-1216G	12" x 16"	Green	Each	12/48
FFT-1216K	12" x 16"	Black	Each	12/48
FFT-1216O	12" x 16"	Orange	Each	12/48
FFT-1216R	12" x 16"	Red	Each	12/48
FFT-1216U	12" x 16"	Burgundy	Each	12/48
FFT-1418B	14" x 18"	Brown	Each	12/48
FFT-1418E	14" x 18"	Grey	Each	12/48
FFT-1418G	14" x 18"	Green	Each	12/48
FFT-1418K	14" x 18"	Black	Each	12/48
FFT-1418O	14" x 18"	Orange	Each	12/48
FFT-1418R	14" x 18"	Red	Each	12/48
FFT-1418U	14" x 18"	Burgundy	Each	12/48

## FIBERGLASS RECTANGULAR DINING TRAY

- ◆ Multi-purpose rectangular tray is perfect for any setting
- ◆ Long-lasting heavyweight tray lasts through years of high-traffic use
- ◆ NSF listed

ITEM	DESCRIPTION	COLOR	UOM	CASE
FGT-1520W	15" x 20"	White	Each	12

## ALUMINUM SERVING TRAYS

*Winco's aluminum sheet pans are not only a baker's default tool for all functions, but are also ideal as serving trays to complement any rustic table setting.*

- ◆ Closed bead with galvanized wire for rust resistance and reinforcement (1/4 and 1/2 size)
- ◆ Made of 3003 aluminum

ITEM	DESCRIPTION	SIZE	GAUGE	UOM	CASE
ALXP-1013	9-1/2" x 13"	1/4-Size	20	Each	24
ALXP-1318	13" x 18"	1/2-Size	20	Each	12

## 6 COMPARTMENT MESS TRAYS

- ◆ Stainless steel mirror finish and dishwasher safe

ITEM	DESCRIPTION	UOM	CASE
SMT-1	15-1/2" x 11-1/2"	Each	24
SMT-2	15-1/2" x 11-1/2"	Each	24



SMT-1



SMT-2

### PLASTIC OVAL PLATTERS

- ◆ Sturdy BPA-free poly plastic
- ◆ Microwave and heat lamp safe up to 150°F (65°C)
- ◆ Great for bread, appetizers, sandwiches and fries
- ◆ Dishwasher safe

ITEM	DESCRIPTION	COLOR	UOM	CASE
PLB-G	10-3/4" x 7-1/4" x 1-1/2"	Green	Doz	12
PLB-K	10-3/4" x 7-1/4" x 1-1/2"	Black	Doz	12
PLB-R	10-3/4" x 7-1/4" x 1-1/2"	Red	Doz	12
PLB-Y	10-3/4" x 7-1/4" x 1-1/2"	Yellow	Doz	12

### FAST FOOD BASKETS



PLB-SERIES BPA FREE

### PREMIUM PLASTIC OVAL BASKETS

- ◆ Sturdy BPA-free poly plastic
- ◆ Microwave and heat lamp safe up to 150°F (65°C)
- ◆ Great for fast dining establishments
- ◆ Choice of five (5) colors
- ◆ Dishwasher safe

ITEM	DESCRIPTION	COLOR	UOM	CASE
POB-G	10-1/4" x 6-3/4" x 2"	Green	Doz	12
POB-K	10-1/4" x 6-3/4" x 2"	Black	Doz	12
POB-R	10-1/4" x 6-3/4" x 2"	Red	Doz	12
POB-Y	10-1/4" x 6-3/4" x 2"	Yellow	Doz	12
PFB-10B	9-1/2" x 5" x 2"	Brown	Doz	3
PFB-10G	9-1/2" x 5" x 2"	Green	Doz	3
PFB-10R	9-1/2" x 5" x 2"	Red	Doz	3



POB-SERIES BPA FREE



PFB-SERIES BPA FREE

### DECORATIVE BAMBOO PICKS

Artfully arrange hor d'oeuvres for a stylish presentation. Use with burgers and sandwiches. Garnish martinis and cocktails with style and ease.

- ◆ Knotted end allows easy pick-up of individual portions
- ◆ Variety of uses: arrange appetizers, hold finger-foods, garnish beverages
- ◆ Biodegradable

ITEM	DESCRIPTION	SIZE	PCS/BAG	UOM	CASE
PK-KT3	Bamboo	3"	100	Bag	12/120
PK-KT4	Bamboo	4"	100	Bag	12/120
PK-KT7	Bamboo	7"	100	Bag	12/120



100 pieces per hanging bag



PK-KT7 PK-KT4 PK-KT3

### DECORATIVE PICKS

#### DECORATIVE PICKS

- ◆ Available in a variety of styles and colors
- ◆ Easily displayed with hanging packaging

ITEM	DESCRIPTION	SIZE	PCS/BAG	UOM	CASE
PK-P4	Parasol	3-15/16"	144	Bag	100
PK-C2	Cellophane Frills	2-9/16"	1,000	Bag	10
PK-C4	Cellophane Frills	3-15/16"	1,000	Bag	10
PK-A35	Plastic Arrow	3-7/16"	500	Bag	20
PK-S3	Plastic Sword	2-3/4"	500	Bag	20

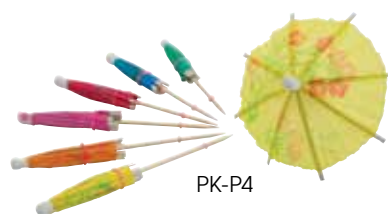

PK-P4



PK-S3



PK-A35



PK-C4



PK-C2

## BAGEL SLICER



**NSF** BGS-1

5"L x 2-1/4"W slot

### BAGEL SLICER

*This commercial-grade polycarbonate bagel slicer promotes fast, convenient and safe slicing, an essential for quick-paced food service venues.*

- ◆ High-carbon, non-stick blade with serrated edge provides precise cuts on every slice
- ◆ Clear guard allows visibility & protects hands/fingers from injury
- ◆ Wide base helps maintain stability while in use
- ◆ Dishwasher safe

ITEM	DESCRIPTION	UOM	CASE
BGS-1	7"L x 3-1/2"W x 9"H	Set	1/12
BGS-1B	Replacement Blade with Guard	Each	1/12

## CONDIMENT DISPENSER



**IMPROVED**

PKTS-2D

**BPA FREE** PKTS-SERIES

### CONDIMENT DISPENSER

*Ideal for busy bars, food stands, convenience stores or fast-food service. Removable plastic fountain jars allow for easy cleaning and refilling.*

- ◆ Durable 18/8 stainless steel, heavy duty pump
- ◆ Two (2) 3-1/2 Qt plastic fountain jars included (7 Qt total)
- ◆ Each pump dispenses between 1 oz and 1-1/4 oz portions, depending on thickness of condiments
- ◆ Overall dimensions: 11"L x 8-3/4"W x 16"H (with pump)
- ◆ Assembly required

ITEM	DESCRIPTION	UOM	CASE
PKTS-2D	Condiment Dispenser with 2 Standard Pumps	Set	1
PKTS-PT01	Individual Pump with Lid	Each	1
PKTS-PT02	Replacement Plastic Fountain Jar	Each	1
PKTS-PT03	Stainless Steel Casing	Each	1

## SQUEEZE BOTTLES



Wide-mouth squeeze bottle

**NO-LEAK DESIGN**



6 per pack

PSW-24

**BPA FREE** PSW-SERIES

### WIDE-MOUTH SQUEEZE BOTTLES

- ◆ Open tip, no need for cutting
- ◆ Each pack contains six (6) pieces
- ◆ BPA-free

ITEM	DESCRIPTION	COLOR	UOM	CASE
PSW-12	12 Oz	Clear	Pack	1/12
PSW-12R	12 Oz	Red	Pack	1/12
PSW-12Y	12 Oz	Yellow	Pack	1/12
PSW-16	16 Oz	Clear	Pack	1/8
PSW-16R	16 Oz	Red	Pack	1/8
PSW-16Y	16 Oz	Yellow	Pack	1/8
PSW-24	24 Oz	Clear	Pack	1/8
PSW-24R	24 Oz	Red	Pack	1/8
PSW-24Y	24 Oz	Yellow	Pack	1/8
PSW-32	32 Oz	Clear	Pack	1/6
PSW-32R	32 Oz	Red	Pack	1/6
PSW-32Y	32 Oz	Yellow	Pack	1/6

### REGULAR SQUEEZE BOTTLES

- ◆ Open tip, no need for cutting
- ◆ Each pack contains six (6) pieces
- ◆ BPA-free

ITEM	DESCRIPTION	COLOR	UOM	CASE
PSB-08C	8 Oz	Clear	Pack	1/12
PSB-08R	8 Oz	Red	Pack	1/12
PSB-08Y	8 Oz	Yellow	Pack	1/12
PSB-12C	12 Oz	Clear	Pack	1/12
PSB-12R	12 Oz	Red	Pack	1/12
PSB-12Y	12 Oz	Yellow	Pack	1/12
PSB-24C	24 Oz	Clear	Pack	1/6
PSB-24R	24 Oz	Red	Pack	1/6
PSB-24Y	24 Oz	Yellow	Pack	1/6

**BPA FREE** PSB-SERIES

### STAINLESS STEEL ROTARY CHEESE GRATER

- ◆ 18/8 stainless steel rotary grater with one drum for grating fine cheeses

ITEM	DESCRIPTION	UOM	CASE
GRTS-1	8-1/4"L x 4-3/4"W x 3-3/8"H	Each	12/36

### PLASTIC ROTARY CHEESE GRATER

- ◆ Ideal for grating hard cheese or chocolate
- ◆ Includes 2 interchangeable drums for fine and coarse grating
- ◆ Dishwasher safe

ITEM	DESCRIPTION	UOM	CASE
PRTS-2	7"L x 3-1/2"W x 4"H	Each	6/24

### ZESTER GRATERS

- ◆ Etched 18/8 stainless steel blade
- ◆ Comes with cover for the blade
- ◆ Comfortable soft-grip handle
- ◆ Superior anti-corrosion properties and durability

ITEM	DESCRIPTION	UOM	CASE
GT-103	Medium Coarse Blade	Each	12/72
GT-104	Zester Blade	Each	12/72
GT-105	Fine Blade	Each	12/72
GT-106	Ribbon Blade	Each	12/72

### CHEESE KNIFE SETS

*Whether it's for a wine tasting event or to accompany dessert, present and serve a full range of cheeses elegantly with these 6-piece cheese knife sets.*

- ◆ Each set includes 6 knives for hard, soft, firm or crumbly cheeses
- ◆ Stainless steel blades

ITEM	DESCRIPTION	UOM	CASE
KCS-6	6-Pc Set w/POM Hdls	Set	1/24
KCS-6W	6-Pc Set w/Wooden Hdls	Set	6/48



WCB-125 with KCS-6

### WOOD BREAD/CHEESE BOARDS

- ◆ Hand wash recommended

ITEM	DESCRIPTION	UOM	CASE
WCB-125	12" x 5" x 3/4"	Each	24
WCB-225	22-1/2"L x 5-1/2"W x 3/4"H	Each	12



## TABLESIDE SERVICE



GRTS-1

PRTS-2



GT-103



GT-104



GT-105



GT-106



KCS-6



KCS-6W



WCB-125



WCB-225



## SEAFOOD SERVICE



ASFT-12



SFR-4



## SEAFOOD TRAYS

Create an enticing tabletop spread with these trays in assorted sizes for displaying seafood or appetizers. The brushed aluminum construction retains cold and keeps foods at safe serving temperatures.

ITEM	DESCRIPTION	UOM	CASE
ASFT-12	12"Dia x 1-1/2"H	Each	12/36
ASFT-14	13-3/4"Dia x 1-1/2"H	Each	12/36
ASFT-16	15-3/4"Dia x 1-1/2"H	Each	12/24
ASFT-18	17-3/4"Dia x 1-1/2"H	Each	12/24
ASFT-20	19-3/4"Dia x 1-1/2"H	Each	12



### CHROME-PLATED SEAFOOD TRAY RACKS

- ◆ Use with ASFT-series seafood trays to create appealing tabletop presentations
- ◆ Also perfect for elevating serving plates, bowls and platters, as well as holding pizza pans

ITEM	DESCRIPTION	UOM	CASE
SFR-4	7-3/8" Top Dia / 9-5/8" Bottom Dia x 4-3/8"H	Each	20
SFR-7	7-3/8" Top Dia / 9-5/8" Bottom Dia x 7"H	Each	20

## LOBSTER CRACKERS

ITEM	DESCRIPTION	SIZE	UOM	CASE
LC-01	Stainless Steel	6"	Each	12/72
LC-03	Chrome Plated, Large	6"	Each	12/144
LC-04	Nut/Lobster Cracker	4-3/4"	Each	24/144
LC-05	Zinc Alloy	6"	Each	12/72
LC-85	Zinc Alloy, Carded	6"	Each	12/72



LC-85



LC-01



LC-03



LC-04

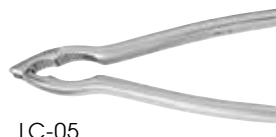

LC-05



### SEAFOOD PICKS

- ◆ 18/8 stainless steel with decorative lobster stamp
- ◆ Narrow two-tine fork designed to effortlessly extract more shellfish meat

ITEM	DESCRIPTION	UOM	CASE
LC-08	8"L x 3/4"W, 4-Pcs/Pk	Pack	30/120



LC-08



SBW-35

## BUTTER WARMER

- ◆ Set includes wire stand, stainless steel butter pan, glass votive holder and candle

ITEM	DESCRIPTION	UOM	CASE
SBW-35	4-Pc Set	Set	1/48

## SNAIL SERVICE

- ◆ Neatly serve escargot
- ◆ Stainless steel

ITEM	DESCRIPTION	UOM	CASE
SND-6	Dish, 6 Wells	Each	12/144
SND-T6	Tongs	Each	12/120
SND-F7	Fork	Doz	1/50



SND-6



SND-T6



SND-F7



### ORDER RACKS

- ◆ Aluminum
- ◆ New style takes up less space to mount, easily fits onto narrow counter edges

ITEM	DESCRIPTION	UOM	CASE
ODR-18N	18"	Each	12/24
ODR-24N	24"	Each	12/24
ODR-36N	36"	Each	12/24
ODR-48N	48"	Each	12/24

### ORDER RACKS & CALL BELLS



ODR-24N

### CALL BELLS

- ◆ Chrome plated with plastic base

ITEM	DESCRIPTION	UOM	CASE
CBEL-1	3-1/2"Dia	Each	12/144
CBEL-2	4"Dia	Each	12/72



CBEL-2



CBEL-1

### RESERVED SIGN

- ◆ Stainless steel

ITEM	DESCRIPTION	UOM	CASE
RVS-4	4-3/4" x 1-3/4", S/S	Each	12/120

### RESERVED SIGN



RVS-4

### TABLE CRUMBERS

- ◆ Aluminum
- ◆ Features a pocket clip

ITEM	DESCRIPTION	UOM	CASE
ATC-16G	6", Gold	Each	120/600
ATC-16S	6", Silver	Each	120/600

### TABLE CRUMBERS



ATC-16G



ATC-16S

### BLACK GUEST ORDER/CHECK HOLDERS

- ◆ Convenient carry size or easily slip into apron pocket
- ◆ Credit card slot; slanted pockets for receipt or order pad

ITEM	DESCRIPTION	UOM	CASE
CHK-1K	10" x 5-1/2"	Each	12/96
CHK-2K	5-1/4" x 8-1/2" w/Elastic Pen Loop	Each	12/96

### CHECK SERVICE



CHK-2K



CHK-1K



Folded with pen tucked in slender spine

### BLACK SERVER BOOK WITH CLEAR SLEEVE

- ◆ 3 flap pockets can hold receipts, order pad, and tips
- ◆ Center sleeve to display daily specials or drinks/deserts
- ◆ Clip a pen to the slender, flexible spine

ITEM	DESCRIPTION	UOM	CASE
CHK-3K	4-1/2" x 9"	Each	24/96



CHK-3K

### CHECK CADDY

ITEM	DESCRIPTION	UOM	CASE
CS-3	3"Dia, Brass-Plated	Each	12/36

### CHECK SPINDLE

ITEM	DESCRIPTION	UOM	CASE
CS-1	6" H, Steel Wire	Each	12/240



CS-1



CS-3

### TIP TRAY

ITEM	DESCRIPTION	UOM	CASE
TT-46	4-1/2" x 6-1/2"	Doz	1/12

### COUNTERFEIT DETECTION PEN

- ◆ Fast and easy way to detect fraudulent bills
- ◆ Great for the busy retail or restaurant environment
- ◆ Can be used with other counterfeit detection methods
- ◆ Each pack contains two (2) pieces

ITEM	DESCRIPTION	UOM	CASE
PPM-2	2-Pcs/Pk	Pack	18/72



PPM-2



TT-46



## CONDIMENT PACKET HOLDER



NSF<sup>®</sup> SCPH-33

SEE PAGE 224  
FOR FOOD  
PANS

### 1/8" STAINLESS STEEL CONDIMENT PACKET HOLDER

- ◆ Fits various configurations 1/3, 1/6 and 1/9-size steam table pans\*
- ◆ Ideal for keeping sugar, salt or sauce packets organized
- ◆ Two openings, each measures 12"L x 6-1/8"W
- ◆ Sloped angle allows easy access on crowded countertops

ITEM	DESCRIPTION	UOM	CASE
SCPH-33	16"L x 13-1/2"W x 9-1/4"H	Each	1/2



\*Pans sold separately

## MINI WASTE CAN



DDSF-101S



### STAINLESS STEEL MINI SWING-LID WASTE CAN

ITEM	DESCRIPTION	UOM	CASE
DDSF-101S	4-3/4"Dia x 6"H	Each	12/48

## TABLETOP DISPENSERS



BPA FREE ACSD-712

### ACRYLIC STRAW DISPENSER

- ◆ Fits 10" long straws
- ◆ Capacity 250 straws
- ◆ BPA-free

ITEM	DESCRIPTION	UOM	CASE
ACSD-712	10-3/4" x 4-3/4" x 7"	Each	6



BPA FREE ACTD-3



### ACRYLIC TOOTHPICK DISPENSER

- ◆ BPA-free

ITEM	DESCRIPTION	UOM	CASE
ACTD-3	3" x 2-1/2" x 4"	Each	6/36



BPA FREE SDP-3



### SAN PLASTIC VERTICAL STRAW DISPENSER

- ◆ Clear, break-resistant SAN plastic cylinder
- ◆ Stainless steel pull-up lid and dispenser insert
- ◆ Capacity 100 straws
- ◆ BPA-free

ITEM	DESCRIPTION	UOM	CASE
SDP-3	3-3/8"Dia x 10-3/4"H	Each	1/12



NH-5



### NAPKIN DISPENSERS

- ◆ Stainless steel

ITEM	DESCRIPTION	UOM	CASE
NH-5	3-1/2"W x 5"H	Each	1/36
NH-7	3-1/2"W x 7"H	Each	1/36



NH-7

### STAINLESS STEEL ASHTRAY

ITEM	DESCRIPTION	UOM	CASE
SAS-4	4"Dia, Stackable	Each	24/96

### ASHTRAYS



SAS-4



MAS-4K



MAS-4R



### PLASTIC ASHTRAYS

- ◆ Heat resistant up to 380°F (193°C)

ITEM	DESCRIPTION	COLOR	UOM	CASE
MAS-4K	4"Dia	Black	Doz	12
MAS-4R	4"Dia	Red	Doz	12



### RECHARGEABLE TEALIGHTS

- ◆ A complete charge provides 12 hours of simulated flickering light
- ◆ Each tealight has an on/off switch on the bottom
- ◆ Includes linkable base, adapter and NiMH battery

ITEM	DESCRIPTION	SIZE	UOM	CASE
CLR-12S	12-Pcs/Pk	11-1/4"L x 3-7/8"W x 4-3/4"H	Set	1/12

### TEALIGHTS



CLR-12S



### BATTERY-OPERATED TEALIGHT

- ◆ Uses one CR2032 battery (included)
- ◆ Lasts over 60 hours

ITEM	DESCRIPTION	UOM	CASE
CL-L	1-1/2"Dia x 1-1/2"H	Each	12/240



CL-L



### STABLEIZER TABLE WEDGES/SHIMS

*sTABLEize the customer's most common complaint of wobbly tables with these economical and practical plastic wedges!*

- ◆ sTABLEize wobbly tables
- ◆ sTABLEize shelves
- ◆ Install commercial glass doors and much more!
- ◆ Each wedge measures 2"L x 1-1/4"W x up to 1/4"H
- ◆ Each pack contains 75 pieces

ITEM	DESCRIPTION	UOM	CASE
TW-75B	Black, Flexible	Pack	48
TW-75W	Translucent, Hard	Pack	48

### TABLE WEDGES

**STABLEizer**  
Installation Shims



75 pcs per container



TW-75B



TW-75W



## WAIT SERVICE APRONS

**SIGNATURE CHEF**



SEE PAGE 168 FOR MERCHANDISING DISPLAY



BADN-3126



Cross-back



LEATHER STRAP DIVIDER



Adjustable neck strap



BADN-3430



BA-3327B  
Model: 5' 3"



BA-3327K



Adjustable neck strap



8 pockets at waist



### HEAVYWEIGHT DENIM BIB APRON, CROSS-BACK

The durable cross-back denim bib apron is a stylish choice for front of house. The dark wash masks spills and stains while keeping up appearances.

- ◆ 80/20 cotton-poly blend
- ◆ Heavyweight dark wash denim
- ◆ Contrast stitching, brass rivets
- ◆ Cross-back straps
- ◆ Metal rings to secure ties
- ◆ Two (2) slanted waist pockets
- ◆ Thermometer/pen pocket
- ◆ 31-3/4"L x 26-3/4"W

Individually packaged in printed poly-bag



Color box with full case purchase

◆ Color display box only available with full case (FC) qty

ITEM	COLOR	UOM	CASE
BADN-3126	Dark Wash w/Brown Straps	Each	12/24



### HEAVYWEIGHT DENIM BIB APRON, ADJUSTABLE NECK

Outfit front of house staff with this hard-wearing dark wash denim apron. Adjust the neck strap to achieve the perfect length.

- ◆ 80/20 cotton-poly blend
- ◆ Heavyweight dark wash denim
- ◆ Contrast stitching
- ◆ Adjustable buckle neck strap
- ◆ Two (2) vertical waist pockets
- ◆ Open chest pocket
- ◆ Zippered cell-phone pocket
- ◆ 34-1/2"L x 30-1/4"W

Individually packaged in printed poly-bag



Color box with full case purchase

◆ Color display box only available with full case (FC) qty

ITEM	COLOR	UOM	CASE
BADN-3430	Dark Wash w/Gray Straps	Each	12/24



### MID-WEIGHT BIB APRONS

These mid-weight bib aprons are the perfect addition to uniforms calling for a streamlined look. Features include an adjustable neck strap, a thermometer pocket, and eight (8) different size waist pockets.

- ◆ Blue apron is 65/35 poly-cotton blend
- ◆ Black apron is 80/20 poly-cotton blend
- ◆ Adjustable snap-button neck strap
- ◆ Thermometer/pen pocket
- ◆ Eight (8) waist pockets
- ◆ 33-1/2"L x 27"W

◆ Color display box only available with full case (FC) qty

ITEM	COLOR	UOM	CASE
BA-3327B	Blue	Each	24/48
BA-3327K	Black	Each	24/48

Individually packaged in printed poly-bag



Color box with full case purchase

### WOVEN CHALKSTRIPE BIB APRON

The stripe pattern of this bib apron is woven in, making for a lasting appearance that stands up to busy service and bartending shifts.

- ◆ 65/35 poly-cotton blend
- ◆ Two (2) waist pockets; designed to hold digital tablets up to 8" wide
- ◆ 33-1/2"L x 27"W

INDIVIDUALLY PACKAGED IN PRINTED POLY-BAG

ITEM	DESCRIPTION	UOM	CASE
BA-3427CS	Chalkstripe w/Pockets	Each	12/60



Woven pattern



Model: 6'

**SIGNATURE CHEF**



BA-3427CS

### 3-POCKET MID-LENGTH BIB APRONS

- ◆ 65/35 poly-cotton blend
- ◆ Adjustable neck strap
- ◆ 24"L x 27-1/2"W

INDIVIDUALLY PACKAGED IN PRINTED POLY-BAG

ITEM	COLOR	UOM	CASE
BA-2724W	White	Each	12/60
BA-2724K	Black	Each	12/60



BA-2724W



BA-2724K  
Model: 5' 3"

### FULL-LENGTH BIB APRONS

- ◆ Pen and pad pockets on select items
- ◆ Cotton-poly blend, machine wash and dry; wrinkle-resistant
- ◆ Assorted colors available
- ◆ 33"L x 26"W

INDIVIDUALLY PACKAGED IN PRINTED POLY-BAG

ITEM	DESCRIPTION	UOM	CASE
BA-3226WH	White, No Pockets	Each	12/60
BA-3226BK	Black, No Pockets	Each	12/60
BA-PBG	Burgundy, w/Pockets	Each	12/60
BA-PBK	Black, w/Pockets	Each	12/60
BA-PBL	Blue, w/Pockets	Each	12/60
BA-PGN	Green, w/Pockets	Each	12/60
BA-PLG	Light Green, w/Pockets	Each	12/60
BA-PRD	Red, w/Pockets	Each	12/60
BA-PWH	White, w/Pockets	Each	12/60



Available Colors

BA-SERIES, WITH PEN & PAD POCKETS



BA-SERIES, WITHOUT POCKETS



BA-PBL  
Model: 6'

## WAIT SERVICE APRONS

**SIGNATURE CHEF**



### BISTRO FULL LENGTH APRONS

These full length bistro/waist aprons are a versatile addition to staff uniforms, easily transitioning from casual to formal, all with a polished look.

- ◆ 65/35 poly-cotton blend
- ◆ Two (2) large utility pockets; fits most digital tablets

ITEM	DESCRIPTION	UOM	CASE
WA-3129WH	White	Each	12/60
WA-3129BK	Black	Each	12/60

INDIVIDUALLY  
PACKAGED IN  
PRINTED POLY-BAG



Models (L to R): 6' / 5' 3" / 5' 7"



### BISTRO HALF LENGTH APRONS

Simple and crisp, the half length bistro aprons are adaptable across a multitude of settings.

- ◆ 65/35 poly-cotton blend
- ◆ Two (2) utility pockets; fits most digital tablets
- ◆ 19"L x 28"W

ITEM	DESCRIPTION	UOM	CASE
WA-2819W	White	Each	12/60
WA-2819K	Black	Each	12/60

INDIVIDUALLY  
PACKAGED IN  
PRINTED POLY-BAG



### FOUR-WAY APRONS

These aprons offer four (4) surfaces for a quick-flip change to present a clean side on the fly, without the need for switching to a new apron.

- ◆ 65/35 poly-cotton blend
- ◆ 17"L x 34"W

ITEM	DESCRIPTION	UOM	CASE
WA4-3417W	White	Each	12/60
WA4-3417K	Black	Each	12/60

INDIVIDUALLY  
PACKAGED IN  
PRINTED POLY-BAG



### 3-POCKET WAIST APRONS

- ◆ Cotton-poly blend, machine wash and dry, wrinkle resistant
- ◆ Available in four (4) colors
- ◆ 12-1/2"L x 21-3/4"W

ITEM	DESCRIPTION	UOM	CASE
WA-1221	Black	Each	12/60
WA-1221G	Green	Each	12/60
WA-1221R	Burgundy	Each	12/60
WA-1221RED	Red	Each	12/60
WA-1221W	White	Each	12/60

INDIVIDUALLY  
PACKAGED IN  
PRINTED POLY-BAG

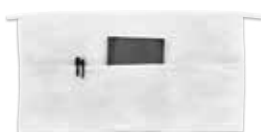

WA-1221RW



WA-1221R



WA-1221G



WA-1221

### WHITE COTTON SERVICE GLOVES

ITEM	DESCRIPTION	COLOR	UOM	CASE
GLC-M	Medium (6 pairs)	White	Doz	100
GLC-L	Large (6 pairs)	White	Doz	100



GLC-M

### COAT HANGERS

- ◆ Open metal hanging hook
- ◆ Notched ends prevent slipping
- ◆ Horizontal bar for draping pants or scarves

ITEM	DESCRIPTION	UOM	CASE
WCH-1	Wooden	Doz	1/10



WCH-1

### COAT CHECK TICKETS

- ◆ Perforated sections with easy-read numbering
- ◆ Large hole fits over hanger
- ◆ Each box contains 500 pieces

ITEM	DESCRIPTION	UOM	CASE
CCK-5BL	Blue Tickets	Box	20
CCK-5PK	Pink Tickets	Box	20
CCK-5WT	White Tickets	Box	20
CCK-5YL	Yellow Tickets	Box	20



CCK-5BL

CCK-5PK



CCK-5WT

CCK-5YL

### TABLE CLOTHS

- ◆ Plastic checkered pattern with cotton lining

ITEM	DESCRIPTION	COLOR	UOM	CASE
TBCS-52B	52" x 52" Square	Blue	Each	24
TBCS-52G	52" x 52" Square	Green	Each	24
TBCS-52R	52" x 52" Square	Red	Each	24
TBCS-52K	52" x 52" Square	Black	Each	24
TBCO-70B	52" x 70" Rectangle	Blue	Each	24
TBCO-70G	52" x 70" Rectangle	Green	Each	24
TBCO-70R	52" x 70" Rectangle	Red	Each	24
TBCO-70K	52" x 70" Rectangle	Black	Each	24
TBCO-90B	52" x 90" Rectangle	Blue	Each	24
TBCO-90G	52" x 90" Rectangle	Green	Each	24
TBCO-90R	52" x 90" Rectangle	Red	Each	24
TBCO-90K	52" x 90" Rectangle	Black	Each	24

### TABLE CLOTHS & CLIPS

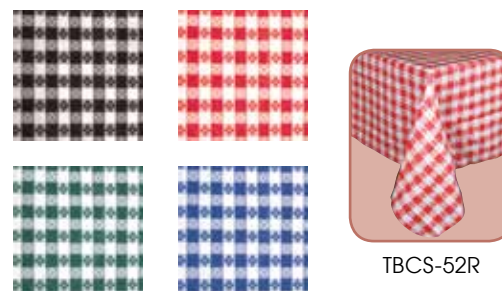

TBCS-52R

Available Colors

TBCS & TBCO-SERIES

### TABLE CLOTH CLIP

- ◆ Perfect for outdoor events

ITEM	DESCRIPTION	UOM	CASE
TBC-1	Stainless steel	Doz	6/60



TBC-1



FITS UP TO  
1-1/2" THICK  
TABLES

Clip holds table  
cloth in place

## DELIVERY BAGS



### DELIVERY BAGS

- ◆ Outer shell/liner: polyester; Filling: EPE
- ◆ Heat retention: 2 hours @ 167°F; 4 hours @ 131°F; 6 hours @ 95°F

ITEM	DESCRIPTION	UOM	CASE
BGDV-12	12" x 12" x 12"	Each	6
BGDV-22	22" x 22" x 12"	Each	6

### PIZZA BAGS

- ◆ Outer shell/liner: polyester; Filling: EPE
- ◆ Insulated lining keeps food warm for longer periods of time

ITEM	DESCRIPTION	UOM	CASE
BGPZ-18	18" x 18" x 5"	Each	6
BGPZ-20	20" x 20" x 5"	Each	6
BGPZ-24	24" x 24" x 5"	Each	6

## FLATWARE ORGANIZERS



### FLATWARE/CUTLERY CYLINDERS & HOLDERS

- ◆ FC-PL/SS/SL fits 4" dia hole

ITEM	DESCRIPTION	UOM	CASE
FC-PL	Perforated, Plastic	Each	36/144
FC-SS	Perforated, S/S	Each	20/80
FC-SL	Solid, S/S	Each	20/80
FC-4H	4-Holes/2-Tier Holder, S/S	Each	1/4
FC-6H	6-Holes/2-Tier Holder, S/S	Each	1/2



FC-4H

### FLATWARE/CUTLERY COMPARTMENT BINS

ITEM	DESCRIPTION	UOM	CASE
PL-4B	Plastic	Each	1/12
SCB-4	Stainless Steel	Each	1/8



PL-4B

SCB-4

OGZ-6

### FLATWARE/CUTLERY ORGANIZERS

ITEM	DESCRIPTION	UOM	CASE
OGZ-6	Organizer Bin Set	Set	1
OGZ-1B	Single Bin for OGZ-6	Each	6



PCB-8

### FLATWARE/CUTLERY DISHWASHER BASKET

- ◆ Built-in handles
- ◆ NSF listed

ITEM	DESCRIPTION	SIZE	UOM	CASE
PCB-8	8 Compartments	17" x 8" x 6"	Each	12

## DINING ROOM MAINTENANCE



### ROTARY SWEEPER

- ◆ Manual, quiet non-electric rotary sweeper with natural bristles and steel handle

ITEM	DESCRIPTION	UOM	CASE
FSW-11	11"L x 7-3/4"W x 43"H	Each	1/4

### DUST PAN WITH COVER

- ◆ Built-in cover for mess-free transport

ITEM	DESCRIPTION	UOM	CASE
DP-13C	13"W Pan	Set	1/10

### ECONOMY FLAGGED ANGLED BROOM W/55"L HANDLE

ITEM	DESCRIPTION	UOM	CASE
BRM-60L	Flagged, 55"L Handle	Each	12



**All Winco® high chairs are in compliance with ASTM F404-18 standards.**

## HIGH-CHAIRS

### STACKABLE WOODEN HIGH-CHAIRS

- ◆ High-quality rubberwood
- ◆ Secure rearward stability, permanent restraint bars, active 3-point harness restraint
- ◆ Assembled size: 20-1/8"W x 19-3/8"D x 29-1/4"H; seat at 20"H

ITEM	DESCRIPTION	UOM	CASE
CHH-101	Natural, Knocked Down	Each	1
CHH-101A	Natural, Assembled	Each	1
CHH-103	Mahogany, Knocked Down	Each	1
CHH-103A	Mahogany, Assembled	Each	1
CHH-104	Walnut, Knocked Down	Each	1
CHH-104A	Walnut, Assembled	Each	1



CHH-101A



CHH-103A

Features on all wooden high chairs:



Rearward Stability



Permanent Restraint Bars



Active 3-Point Harness



CHH-104A



CHH-601

### WOODEN PUB-HEIGHT HIGH-CHAIR

- ◆ Assembled size: 22-1/4"W x 26-3/4"D x 41"H; seat at 32"H

ITEM	DESCRIPTION	UOM	CASE
CHH-601	Natural, Knocked Down	Each	1

**All Winco® booster seats are in compliance with ASTM F2640-18 standards.**

## BOOSTER SEATS

### STACKABLE WOODEN BOOSTER SEATS

- ◆ High-quality rubberwood
- ◆ Active 3-point harness restraint
- ◆ 2 additional straps below for securing to a chair
- ◆ Size: 11-3/4"W x 11-3/4"D x 10-1/2"H
- ◆ Minimum chair seat requirements: 15"W x 12"D x 10"H

ITEM	DESCRIPTION	UOM	CASE
CHB-701	Natural	Each	1
CHB-703	Mahogany	Each	1
CHB-704	Walnut	Each	1



Adjustable straps w/buckle secure booster to seat and back of chair



CHB-704



CHB-703



CHB-701

### PLASTIC BOOSTER SEATS

- ◆ Contoured seat, high sides, wide base & non-skid surface
- ◆ Durable polyethylene resists dents/chips, won't break or rust
- ◆ Active 3-point center harness restraint
- ◆ 2 additional, adjustable straps w/buckle secure booster to the seat and back of a chair
- ◆ Dishwasher safe for convenient cleaning
- ◆ Size: 12"W x 11-7/8"D x 9-1/4"H
- ◆ Minimum chair seat requirements: 15"W x 13"D x 12"H

ITEM	DESCRIPTION	UOM	CASE
CHB-1PK	Black	Each	1
CHB-1P	Brown	Each	1

Replaces current CHB-2PK / -2P



CHB-1PK



CHB-1P

# INFORMATION SIGNS



SGN-SERIES  
9" X 3"

Our information/way-finding signs are available in 9" x 3" and 6" x 9" sizes with universal symbols and clear letters on anti-glare black surface.

- ◆ Durable plastic construction
- ◆ Self-adhesive backing for easy mounting

## 9"W X 3"H INFORMATION SIGNS

ITEM	DESCRIPTION	COLOR	UOM	CASE
SGN-301	Push	Black	Each	12/144
SGN-302	Pull	Black	Each	12/144
SGN-303	Hand Wash Only	Black	Each	12/144
SGN-304	Private	Black	Each	12/144
SGN-305	Employees Only	Black	Each	12/144
SGN-310	No Smoking	Black	Each	12/144
SGN-311	Men	Black	Each	12/144
SGN-312	Women	Black	Each	12/144
SGN-313	Restrooms	Black	Each	12/144
SGN-317	Restroom for Customer Use Only	Black	Each	12/144
SGN-318	Wash	Black	Each	12/144
SGN-322	Employees Must Wash Hands Before Returning to Work	Black	Each	12/144
SGN-325	Telephone	Black	Each	12/144
SGN-326	Caution/Watch Your Step	Black	Each	12/144
SGN-327	Rinse	Black	Each	12/144
SGN-328	Reserved	Black	Each	12/144
SGN-329	Sanitize	Black	Each	12/144
SGN-330	WiFi	Black	Each	12/144
SGN-331	No Admittance	Black	Each	12/144
SGN-332	No Pets/Shoes Shirt Required	Black	Each	12/144
SGN-333	No Food or Drink	Black	Each	12/144
SGN-334	No Cell Phone Use, Please	Black	Each	12/144
SGN-335	No E-Cigarettes	Black	Each	12/144
SGN-336	No Soliciting	Black	Each	12/144
SGN-381W	Exit	White	Each	12/144
SGN-382W	Fire Extinguisher	White	Each	12/144



SGN-SERIES  
(SPANISH)  
9" X 3"

## 9"W X 3"H INFORMATION SIGNS, SPANISH

ITEM	DESCRIPTION	COLOR	UOM	CASE
SGN-360	Employees Must Wash Hands	Black	Each	12/144
SGN-361	Employees Only	Black	Each	12/144
SGN-362	Restrooms	Black	Each	12/144
SGN-363	Wash	Black	Each	12/144
SGN-364	No Smoking	Black	Each	12/144
SGN-365	Rinse	Black	Each	12/144
SGN-366	Hand Wash Only	Black	Each	12/144
SGN-367	Sanitize	Black	Each	12/144
SGN-368	Men	Black	Each	12/144
SGN-369	Women	Black	Each	12/144

SGN-336

### 6"W X 9"H INFORMATION SIGNS

ITEM	DESCRIPTION	COLOR	UOM	CASE
SGN-601	No Smoking	Black	Each	12/72
SGN-603	Restrooms	Black	Each	12/72
SGN-651B	Women	Blue	Each	12/72
SGN-652B	Men	Blue	Each	12/72
SGN-653B	Accessible	Blue	Each	12/72
SGN-681W	Exit	White	Each	12/72
SGN-682W	Fire Extinguisher	White	Each	12/72
SGN-683W	In Case of Fire Do Not Use Elevator...	White	Each	12/72
SGN-684W	No Smoking Area	White	Each	12/72

### INFORMATION SIGNS



SGN-SERIES  
6" X 9"

### 6"W X 9"H INFORMATION SIGNS WITH BRAILLE

ITEM	DESCRIPTION	COLOR	UOM	CASE
SGNB-607	All Gender Restroom	Black	Each	12/72
SGNB-608	All Gender Restroom w/ Accessible	Black	Each	12/72
SGNB-601	No Smoking	Black	Each	12/72
SGNB-603	Restrooms	Black	Each	12/72
SGNB-604	Exit	Black	Each	12/72
SGNB-605	Men	Black	Each	12/72
SGNB-606	Women	Black	Each	12/72
SGNB-651B	Women/Accessible	Blue	Each	12/72
SGNB-652B	Men/Accessible	Blue	Each	12/72
SGNB-653B	Accessible	Blue	Each	12/72



Tactile raised braille dots



SGNB-SERIES  
6" X 9"

### LED SIGNS

*These bright, eye-catching signs are a great way to let customers know your establishment is open for business. Easy pull-string operation and highly visible.*

- ◆ Highly visible light-emitting diode/LED technology
- ◆ Lightweight; chain for hanging included
- ◆ Built-in dust proof cover
- ◆ Black adaptor with 118"L (3 meters) power cord included: UL listed
- ◆ 120V ~ 60Hz

### "OPEN" LED SIGNS

- ◆ LED-6: 22"L x 1-1/2"W x 13"H
- ◆ LED-10: 22-3/4"W x 1-3/4"W x 14"H

ITEM	DESCRIPTION	UOM	CASE
LED-6	Rectangle, 1 Flashing Pattern	Each	1/5
LED-10	Oval, 3 Flashing Patterns	Each	1/5

### LED SIGNS

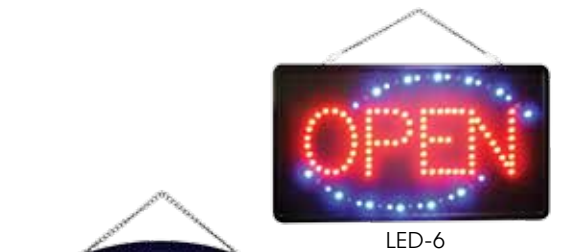

LED-6



LED-10



LED-11

### "PIZZA" LED SIGN

- ◆ LED-11: 22-3/4"L x 1-3/4"W x 14"H

ITEM	DESCRIPTION	UOM	CASE
LED-11	Oval, 3 Flashing Patterns	Each	1/5

LED-SERIES

## STANCHION SIGN SYSTEMS



CGSF-12K



CGSF-12S



CGS-38K



CGS-38S



CGS-WB



CGS-K

### STANCHION SIGN SYSTEMS

- ◆ 34" high stanchions with heavy, sturdy base and built-in 6-1/2 ft long retractable belt (overall 35-1/2"H)
- ◆ Stanchions must be purchased in multiples of two (2)

ITEM	DESCRIPTION	UOM	CASE
CGS-38K	Black Stanchion	Each	2
CGS-38S	Stainless Steel Stanchion	Each	2
CGS-WB	Wall Bracket for CGS-38K/S	Each	100
CGS-K	Plstc Head w/Black Belt for CGS-38K/S	Each	12/48
CGSF-12K	Black Frame for CGS-38K	Each	1/4
CGSF-12S	Stainless Steel Frame for CGS-38S	Each	1/4

### STANCHION FRAME SIGNS

- ◆ 2-sided pre-printed signs provide maximum visibility

ITEM	DESCRIPTION	UOM	CASE
SGN-801	Please Enter Here	Each	6/36
SGN-802	Please Wait To Be Seated	Each	6/36
SGN-803	Line Forms Here	Each	6/36
SGN-804	Sorry Section Closed	Each	6/36
SGN-805	Exit	Each	6/36



SGN-800 SERIES

## HOSTESS SIGN



### HOSTESS SIGN

- ◆ 60" tall sign stand with interchangeable messages
- ◆ Includes 15 message signs, pole and base
- ◆ Easy to assemble

ITEM	DESCRIPTION	UOM	CASE
HTS-60K	Sign Frame w/Pole & Base	Set	1/4



HTS-60K



14 messages and 1 blank included

## DISPLAY SIGNAGE BOARDS & ACCESSORIES

- ◆ Perfect for bakeries, cafes, coffee shops, pubs and restaurants
- ◆ Made for frequently changing specials, the High-tech Absol-Flat black glossy surface allows for clean and mess-free writing
- ◆ Solid 1-1/4" wide frame with double reinforced joints
- ◆ Durable packaging prevents damage while in transit

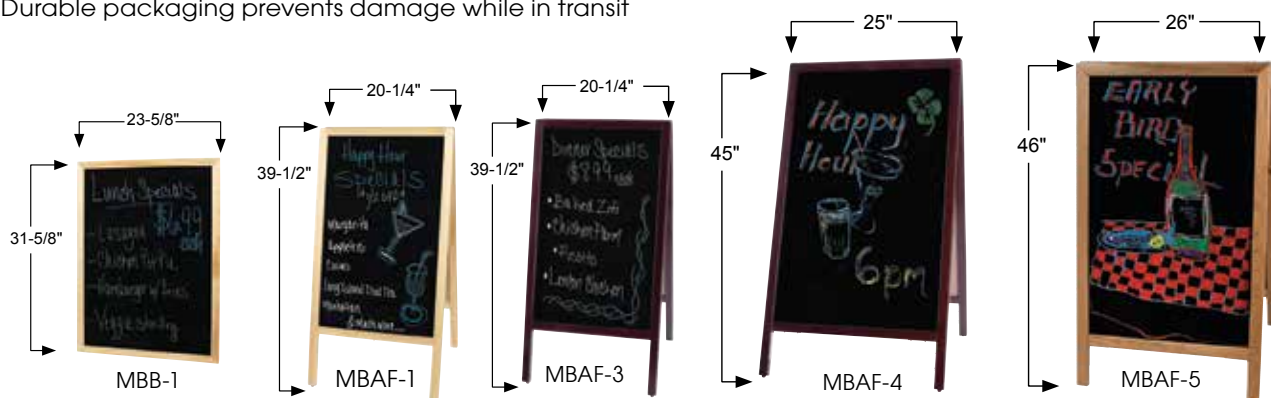

### WOODEN FRAME MARKER BOARDS

ITEM #	DESCRIPTION	INCLUDES	SIZE	UOM	CASE
MBB-1	Natural	1 Standard White Marker & Eraser	23-5/8"L x 3/4"W x 31-5/8"H	Set	6
MBB-3	Mahogany	1 Standard White Marker & Eraser	23-5/8"L x 3/4"W x 31-5/8"H	Set	1/6

### DUAL-SIDED SIDEWALK A-FRAME MARKER BOARDS

ITEM #	DESCRIPTION	INCLUDES	SIZE	UOM	CASE
MBAF-1	Natural	4 Standard Markers & Eraser	20-1/4"L x 2"W x 39-1/2"H	Set	1
MBAF-3	Mahogany	4 Standard Markers & Eraser	20-1/4"L x 2"W x 39-1/2"H	Set	1
MBAF-4	Mahogany	4 Standard, 2 Deluxe Plus Markers & Eraser	25"L x 2"W x 45"H	Set	1
MBAF-5	Premium White Oak	2 Standard, 4 Deluxe Plus Markers & Eraser	26"L x 2"W x 46"H	Set	1



### PREMIUM TRIPOD DISPLAY EASEL

- ◆ A stylish lift to the wood frame marker boards
- ◆ Solid, 1" thick wooden frame has two adjustable deluxe planes with pure copper knobs, comes with rubber feet
- ◆ Factory assembled ensures superior stability over knock-down easels

ITEM #	DESCRIPTION	SIZE	UOM	CASE
MBBE-1	Natural	23-1/4"L x 1"W x 61"H	Set	1
MBBE-3	Mahogany	23-1/4"L x 1"W x 61"H	Set	1



MBB-3 AND MBBE-3 GROUP



MBBE-1

*With floral ink to deliver the most vivid color, the Deluxe Plus markers write on every kind of surface.*

ITEM #	DESCRIPTION	SIZE	COLOR	UOM	CASE
MBPM-B	Deluxe Plus	15g Ink, 1/16" Chisel	Neon Blue	Each	72/288
MBPM-G	Deluxe Plus	15g Ink, 1/16" Chisel	Neon Green	Each	72/288
MBPM-O	Deluxe Plus	15g Ink, 1/16" Chisel	Neon Orange	Each	72/288
MBPM-P	Deluxe Plus	15g Ink, 1/16" Chisel	Neon Pink	Each	72/288
MBPM-R	Deluxe Plus	15g Ink, 1/16" Chisel	Neon Red	Each	72/288
MBPM-U	Deluxe Plus	15g Ink, 1/16" Chisel	Neon Purple	Each	72/288
MBPM-W	Deluxe Plus	15g Ink, 1/16" Chisel	Neon White	Each	72/288
MBPM-Y	Deluxe Plus	15g Ink, 1/16" Chisel	Neon Yellow	Each	72/288
MBM-B	Standard	12g Ink, 1/4" Bullet	Neon Blue	Each	72/288
MBM-G	Standard	12g Ink, 1/4" Bullet	Neon Green	Each	72/288
MBM-P	Standard	12g Ink, 1/4" Bullet	Neon Pink	Each	72/288
MBM-R	Standard	12g Ink, 1/4" Bullet	Neon Red	Each	72/288
MBM-W	Standard	12g Ink, 1/4" Bullet	Neon White	Each	72/288
MBM-Y	Standard	12g Ink, 1/4" Bullet	Neon Yellow	Each	72/288
MB-E	Easy Wipe Eraser			Each	72/288

### DELUXE NEON MARKERS & ERASER



Deluxe Plus Broad Chisel Tip Markers



Standard Bullet Tip Markers



MB-E



DELUXE PLUS SERIES



STANDARD SERIES



## VIRTUOSO™ COFFEE URNS

SEE PAGE 64 FOR MATCHING VIRTUOSO CHAFERS



905A



903B

The modern design of the Virtuoso urns will add a stylish touch to any coffee and tea self-service station. The gleaming mirror-finish body is available in 3 gallon (11.3L) and 5 gallon (18.9L) capacities. A single fuel canister will keep contents warm and ready for dispensing.

- ◆ Extra-heavyweight stainless steel
- ◆ Available with gold-tone accents or all stainless steel
- ◆ Mirror finish

ITEM	DESCRIPTION	UOM	CASE
905A	5 Gal (18.9L), Two-Tone	Set	1
905B	5 Gal (18.9L), Stainless Steel	Set	1
903A	3 Gal (11.3L), Two-Tone	Set	1
903B	3 Gal (11.3L), Stainless Steel	Set	1
FAUCET-CU	Stainless Steel Faucet	Each	1
FAUCET-JD	Plastic Faucet	Each	1



FAUCET-CU



FAUCET-JD

## VIRTUOSO™ JUICE DISPENSER

NEW



908  
11-1/2"L x 13-1/2"W x 21"H  
6-1/2"H base

COOL & REFRESHING, NOT WATERED DOWN



## VIRTUOSO™ JUICE DISPENSER

The Virtuoso design is now available in a dispenser for cold beverages, complete with center ice core to keep drink offerings chilled without watering them down. Ideal for infused water, ice tea, juice, lemonade and more.

- ◆ Break-resistant, clear plastic container provides excellent product visibility
- ◆ Mirror finish stainless steel base, core and lid for optimal durability
- ◆ Hand wash to maintain ideal condition; do not use abrasive cleaners

ITEM	DESCRIPTION	UOM	CASE
908	3 Gal (11.3L), Mirror S/S	Set	1



CHILL WITH ICE CORE

## PUNCH BOWL



SPB-35

## STAINLESS STEEL PUNCH BOWL

- ◆ Mirror finish
- ◆ Footed base
- ◆ Decorative ring handles

ITEM	DESCRIPTION	UOM	CASE
SPB-35	3-1/2 Gal (13.25L)	Each	6

These beverage dispensers are perfect for serving refreshing, cool drinks. Fill the inner center tube with ice to chill from within without watering down beverages.

- ◆ Ice core allows chilling without watering down
- ◆ Break-resistant polycarbonate containers
- ◆ Removable container and drip tray for easy cleaning
- ◆ Maintain ideal condition and clean by hand with warm, soapy water and soft cloth/sponge; abrasive cleaners will scratch the surface

**PEDESTAL JUICE DISPENSERS WITH ICE CORE**

- ◆ Mirror finish; available with either gold-tone accents or all stainless steel details
- ◆ Break-resistant, clear plastic container provides excellent product visibility
- ◆ Ideal for juice and a variety of cold beverages

ITEM	DESCRIPTION	UOM	CASE
901	2.2 Gal (8.3L), Two-Tone	Set	1
902	2.2 Gal (8.3L), Stainless Steel	Set	1

**ACCESSORIES FOR JUICE DISPENSERS**

- ◆ Clean polycarbonate container by hand with warm, soapy water and soft cloth/sponge; abrasive cleaners will scratch the surface

ITEM	DESCRIPTION	UOM	CASE
901-FN	Faucet for 901, 902	Each	12/48
901-P1	PC Jar for 901, 902	Each	4

**COLD BEVERAGE DISPENSERS**

CHILL WITH ICE CORE



902  
10-1/8"L x 13-3/4"W x 21-1/4"H



901  
10-1/8"L x 13-3/4"W x 21-1/4"H



901-FN 901-P1

**COLD BEVERAGE DISPENSER WITH ICE CORE**

- ◆ Fill the ice core to keep beverages chilled without diluting
- ◆ Break-resistant, clear plastic container provides excellent product visibility
- ◆ 8" high base is detachable for compact storage
- ◆ Brushed finish stainless steel base, core and lid for optimal durability
- ◆ Tight-fitting lid keeps contents free from contaminants
- ◆ Ideal for infused water, juice, iced tea and more
- ◆ Hand wash recommended to maintain ideal condition; do not use abrasive cleaners

ITEM	DESCRIPTION	UOM	CASE
904	2.25 Gal, Brushed S/S	Set	1/4



Fill center tube with ice



904  
9-1/8"L x 10"W x 22"H  
8"H base

**PLASTIC BEVERAGE DISPENSERS**

These slim rectangular or compact square dispensers are the ideal choice when counter space is limited.

- ◆ Graduated reservoir with leak-proof faucet stands on 8" tall base
- ◆ Detachable drip tray and lid
- ◆ BPA-free

ITEM	DESCRIPTION	UOM	CASE
PBD-3	3 Gal (11.3L), Slim Rectangular Dispenser	Each	1
PBD-3SK	3 Gal (11.3L), Square Dispenser	Each	4
PBD-3-F	Faucet for PBD-3	Each	1
PBD-3SK-F	Faucet for PBD-3SK	Each	1/50



PBD-3SK



PBD-3 NSF

PBD-SERIES BPA FREE

## COLD BEVERAGE DISPENSERS



## COLD BEVERAGE DISPENSERS

These tall and slender iced tea dispensers are the ideal solution for narrow countertops. Available in 3 gallon (11.3L) and 5 gallon (18.9L) sizes.

- ◆ Stainless steel with a welded handle on front
- ◆ Tall faucet with a detachable drip tray
- ◆ Includes 3 color decals: "Iced Tea", "Lemonade" and "Iced Coffee", as well as 1 blank decal for customization

ITEM	DESCRIPTION	SIZE	UOM	CASE
SSBD-3	3 Gal (11.3L)	6-7/8"W x 13-3/4"D x 21"H	Set	1
SSBD-5	5 Gal (18.9L)	6-7/8"W x 18-7/8"D x 21-1/4"H	Set	1



3 color and 1 blank decal included

## BEVERAGE CONTAINER DISPENSER



PBDW-22

## PLASTIC BEVERAGE DISPENSER

Perfect for mixing and serving a variety of beverages, this 6 gallon (22.7L) container/dispenser comes with a snap-on lid, and is fitted with a handle for secure and easy transport.

- ◆ Leak-proof faucet
- ◆ Bail handle with comfortable handgrip
- ◆ Red graduations in liters and quarts
- ◆ Withstands temps from -40°F (-40°C) to 160°F (71°C)
- ◆ Dishwasher safe
- ◆ BPA-free

**BPA FREE** PBDW-SERIES

ITEM	DESCRIPTION	UOM	CASE
PBDW-22	6 Gal, (22.7L) PP	Each	1/4
PBDW-FS	Faucet for PBDW-22	Each	1

## WIRE AIRPOT RACKS



APRK-4

Shown with four airpots, sold separately

15"L X 25"D X 26-1/2"H (WITH SIGN)

APRK-6

22"L X 25"D X 26-1/2"H (WITH SIGN)

## WIRE AIRPOT RACKS

Ideal for countertop self-service. Economize space and keep service areas tidy with sturdy wire airpot racks. Available in both single and double-tiers.

- ◆ Ideal for self-service countertop beverage stations
- ◆ Features three (3) sizes to accommodate different configurations
- ◆ Sturdy 1/4" thick heavy-duty wire construction resists bending or breaking
- ◆ Removable stainless steel drip tray(s) for easy cleanup
- ◆ Each rack features a sign holder to identify contents
- ◆ Fits Winco® APSK, APSP and AP-series airpots

ITEM	DESCRIPTION	UOM	CASE
APRK-4	Two Levels, Holds 4 Airpots	Set	1/2
APRK-6	Two Levels, Holds 6 Airpots	Set	1/2

### Sets Include:

- ◆ Wire Rack(s)
- ◆ Drip Tray(s)
- ◆ Sign Hanger
- ◆ Label Holder
- ◆ Two Legs
- ◆ Cross Brace
- ◆ Support Bars



## AIRPOTS

Keep beverages hotter longer with these attractive stainless steel or glassed-lined airpots by Winco®. Double-wall insulation protects from damage and retains heat for an extended length of time. Ideal for concession stands, catered events, self-serve counters, offices and more.



### STAINLESS STEEL LINED AIRPOTS

- ◆ Available with push button or lever top
- ◆ Heat retention: 10 hours at 175°F; 24 hours at 151°F
- ◆ Swivel base for easy access
- ◆ Double-wall insulated
- ◆ Stainless steel satin-finish body
- ◆ Includes four (4) "Lift & Twist" color tags for **Coffee, Decaf, Tea & Hot water**

ITEM	DESCRIPTION	UOM	CASE
APSK-725	2.5L Lever Top	Each	1/6
APSK-730	3L Lever Top	Each	1/6
APSP-925	2.5L Push Button	Each	1/6
APSP-930	3L Push Button	Each	1/6



### GLASS LINED AIRPOTS

- ◆ Available with push button or lever top
- ◆ Heat retention: 10 hours at 171°F; 24 hours at 147°F
- ◆ Swivel base for easy access
- ◆ Double-wall insulated
- ◆ Stainless steel satin-finish body
- ◆ Includes four (4) "Lift & Twist" color tags for **Coffee, Decaf, Tea & Hot water**

- ◆ Handle with care: Fragile glass liner

ITEM	DESCRIPTION	UOM	CASE
AP-522	2.2L Push Button	Each	1/6
AP-525	2.5L Push Button	Each	1/6
AP-535	3L Push Button	Each	1/6
AP-819	1.9L Lever Top	Each	1/6
AP-822	2.2L Lever Top	Each	1/6
AP-825	2.5L Lever Top	Each	1/6
AP-835	3L Lever Top	Each	1/6

### AIRPOT REPLACEMENT LIDS

- ◆ Fit APSK-Series, APSP-Series and AP-Series airpots

ITEM	DESCRIPTION	UOM	CASE
AP-LTW	Lever-Top Lid	Each	50
AP-PTW	Push-Button Lid	Each	48

## AIRPOTS



## GRAVITY BEVERAGE DISPENSER



SBD-1.5



## GRAVITY BEVERAGE DISPENSER WITH SIGHT GLASS

An ideal solution for busy self-service stations, this gravity beverage dispenser features a sight glass to view level of contents for refill needs and a brew-thru lid for brewing directly into the dispenser.

- ◆ Patented structure easily detaches body from stand
- ◆ Tomlinson® faucet with protection guard
- ◆ Double-wall vacuum insulated
- ◆ Retains heat for 4-6 hours
- ◆ Sturdy plastic handle for easy lifting and carrying
- ◆ Stainless steel satin-finish

ITEM	DESCRIPTION	UOM	CASE
SBD-1.5	1.5 Gal	Each	1/1

## STAINLESS STEEL BEVERAGE SIGNS



SGN-SERIES  
TENT SIGNS

With oversized black letters on stainless steel, these beverage tent and chain signs are must-haves for buffets and beverage stations.

### STANDING TENT SIGNS

- ◆ 3"L x 1-1/4"H x 1-1/2"D

ITEM	DESCRIPTION	UOM	CASE
SGN-100	Blank Sign	Each	12/120
SGN-101	Hot Tea	Each	12/120
SGN-102	Decaf	Each	12/120
SGN-103	Coffee	Each	12/120
SGN-104	Hot Water	Each	12/120
SGN-105	Iced Tea	Each	12/120

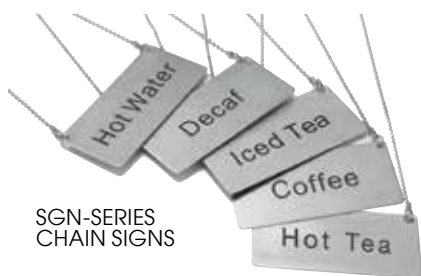

SGN-SERIES  
CHAIN SIGNS

### HANGING CHAIN SIGNS

- ◆ 3-1/2"L x 1-3/4"W sign with 12" long chain

ITEM	DESCRIPTION	UOM	CASE
SGN-201	Hot Tea	Each	12/120
SGN-202	Decaf	Each	12/120
SGN-203	Coffee	Each	12/120
SGN-204	Hot Water	Each	12/120
SGN-205	Iced Tea	Each	12/120

## DRIP TRAYS



DT-45



DT-60



## DRIP TRAYS

- ◆ Removable grid for easy cleaning; dishwasher safe
- ◆ Each pack contains four (4) pieces
- ◆ BPA-free

ITEM	DESCRIPTION	UOM	CASE
DT-45	4-1/2" Tray, 4 pcs/pk	Pack	12/24
DT-60	6" Tray, 4 pcs/pk	Pack	12/24



DT-SERIES



**SWIRL DESIGN PUSH BUTTON BEVERAGE SERVERS**

- ◆ Double-wall insulated with durable plastic body
- ◆ Includes tags for regular, decaf and tea
- ◆ Available in black or white
- ◆ Hand wash only

ITEM	DESCRIPTION	UOM	CASE
VSW-20W	20 Oz, White	Each	1/24
VSW-42W	42 Oz, White	Each	1/12
VSW-64W	64 Oz, White	Each	1/6
VSW-20K	20 Oz, Black	Each	1/24
VSW-42K	42 Oz, Black	Each	1/12
VSW-64K	64 Oz, Black	Each	1/6

**INSULATED SERVERS**



VSW-64W

VSW-64K

VSW-SERIES NSF

**STAINLESS STEEL LINED COFFEE SERVER**

- ◆ Double-wall insulated; satin-finish

ITEM	DESCRIPTION	UOM	CASE
VSS-508	20 Oz	Each	12



VSS-508

ALL STAINLESS STEEL

**CARAFES**

- ◆ Stainless steel lined
- ◆ Heat retention: 6 hours at 171°F; 24 hours at 121°F
- ◆ Double-wall insulated
- ◆ Push button

ITEM	DESCRIPTION	UOM	CASE
CF-1.2	1.2L	Each	1/8
CF-1.5	1.5L	Each	1/8
CF-2.0	2L	Each	1/8
CF-LID	Lid for CF-1.2/1.5/2.0	Each	1



CF-1.5

CF-2.0

CF-1.2

**COFFEE/CREAM SERVERS**

- ◆ Double-wall stainless steel vacuum insulation keeps liquids hot or cold for a longer period of time
- ◆ Stainless steel lined interior provides extra durability and safety

ITEM	DESCRIPTION	UOM	CASE
VSS-24	24 Oz	Each	12
VSS-33	33 Oz	Each	12



VSS-24

VSS-33

## STAINLESS STEEL PITCHERS



WPB-2H



WPB-2CH



WPB-2



WPB-2C



BS-64



WPG-64



JB2928

TRUE  
28OZ  
CAPACITY



GS-10



W632



## HAMMERED BELL PITCHERS

*Stylish and versatile, the hammered mirror-finish bell pitcher is great for serving cold beverages. Ice guard version also available!*

ITEM	DESCRIPTION	UOM	CASE
WPB-2H	2 Qt	Each	1/24
WPB-2CH	2 Qt w/Ice Guard	Each	1/24
WPB-3H	3 Qt	Each	1/24
WPB-3CH	3 Qt w/Ice Guard	Each	1/24

## DELUXE BELL PITCHERS

ITEM	DESCRIPTION	UOM	CASE
WPB-2	2 Qt	Each	1/24
WPB-2C	2 Qt w/Ice Guard	Each	1/24
WPB-3	3 Qt	Each	1/24
WPB-3C	3 Qt w/Ice Guard	Each	1/24

## CLASSIC COFFEE & WATER SERVERS

ITEM	DESCRIPTION	UOM	CASE
BS-64	64 Oz Coffee Server	Each	1/12
WPG-64	64 Oz Water Pitcher with Ice Guard	Each	1/12



## GOOSENECK TEAPOTS

ITEM	DESCRIPTION	UOM	CASE
JB2920	20 Oz	Each	1/24
JB2928	28 Oz	Each	1/24
JB2932	32 Oz	Each	1/24



## GOOSENECK SERVER/CREAMER

ITEM	DESCRIPTION	UOM	CASE
GS-10	10 Oz	Each	1/36



## SHORT SPOUT BEVERAGE SERVERS

ITEM	DESCRIPTION	UOM	CASE
W612	12 Oz	Each	1/50
W632	32 Oz	Each	1/50
W670	70 Oz	Each	1/30

## TEAPOT & ACCESSORIES



GTP-25



## 25 OZ GLASS TEAPOT WITH INFUSER BASKET

*Serve freshly steeped tea in this attractive glass teapot with removable stainless steel infuser basket, the perfect complement to any tea service.*

- ◆ Fine stainless steel mesh strainer
- ◆ Glass carafe cradled in plastic body, suitable for loose tea brewing

ITEM	DESCRIPTION	UOM	CASE
GTP-25	25 Oz, 6"L x 4-3/4"W x 5-1/2"H	Each	1/48

## GLASS HOTTLE

- ◆ Non-slip, heat resistant plastic grip; includes plastic lid
- ◆ Can also be used to steep tea
- ◆ Dishwasher safe

ITEM	DESCRIPTION	UOM	CASE
GHT-10	10 Oz	Each	12/24
GHT-10C	Replacement Lid for GHT-10	Each	12/600



GHT-10



GHT-10C



STB-7

## STAINLESS STEEL TEA INFUSER BALL

ITEM	DESCRIPTION	UOM	CASE
STB-5	2"	Each	40/240
STB-7	3"	Each	40/240

**WATER PITCHERS**

◆ BPA-free break-resistant SAN plastic

ITEM	DESCRIPTION	UOM	CASE
WPS-32	32 Oz, 4-Pcs/Pk	Pack	12
WPS-60	60 Oz, 4-Pcs/Pk	Pack	8



**WATER PITCHER WITH ICE TUBE**

ITEM	DESCRIPTION	UOM	CASE
WPIT-19	64 Oz, PC	Each	1/12

**THREE-SPOUT WATER PITCHERS**

ITEM	DESCRIPTION	UOM	CASE
WPCT-60A	60 Oz, Amber, PC	Each	12
WPCT-60C	60 Oz, Clear, PC	Each	12

**SINGLE SPOUT CLEAR WATER PITCHERS**

ITEM	DESCRIPTION	UOM	CASE
WPC-32	32 Oz, PC	Each	1/12
WPC-48	48 Oz, PC	Each	12
WPC-60	60 Oz, PC	Each	1/12

**BEER PITCHER**

ITEM	DESCRIPTION	UOM	CASE
WPCB-60	60 Oz, PC	Each	12

**DECANTERS WITH FLIP TOP LIDS**

◆ NSF listed

ITEM	DESCRIPTION	UOM	CASE
PDT-05	0.5 Qt, PC	Each	24
PDT-10	1 Qt, PC	Each	24
PDT-15	1.6 Qt, PC	Each	24

**PLASTIC PITCHERS**



WPS-32

**BPA FREE**

WPS-60

**BPA FREE**



WPIT-19

WPCT-60A

WPCT-60C



WPC-SERIES

WPCB-60

PDT-SERIES

**NSF**

**NSF**

**NSF**



**HAVANA TUMBLERS**

◆ BPA-free break-resistant SAN plastic

◆ Safe for commercial dishwasher

ITEM	DESCRIPTION	SIZE	UOM	CASE
PTSN-9	Blue	9 Oz	Doz	6
PTSN-12	Blue	12 Oz	Doz	6
PTSN-16	Blue	16 Oz	Doz	4



**PEBBLED TUMBLERS**

ITEM	DESCRIPTION	SIZE	UOM	CASE
PTP-05A	Amber	5 Oz	Doz	6
PTP-05B	Blue	5 Oz	Doz	6
PTP-05C	Clear	5 Oz	Doz	6
PTP-05R	Red	5 Oz	Doz	6
PTP-08A	Amber	8 Oz	Doz	6
PTP-08B	Blue	8 Oz	Doz	6
PTP-08C	Clear	8 Oz	Doz	6
PTP-08R	Red	8 Oz	Doz	6
PTP-09A	Amber	9-1/2 Oz	Doz	6
PTP-09B	Blue	9-1/2 Oz	Doz	6
PTP-09C	Clear	9-1/2 Oz	Doz	6
PTP-09R	Red	9-1/2 Oz	Doz	6
PTP-12A	Amber	12 Oz	Doz	6
PTP-12B	Blue	12 Oz	Doz	6
PTP-12C	Clear	12 Oz	Doz	6
PTP-12R	Red	12 Oz	Doz	6
PTP-16A	Amber	16 Oz	Doz	6
PTP-16B	Blue	16 Oz	Doz	6
PTP-16C	Clear	16 Oz	Doz	6
PTP-16R	Red	16 Oz	Doz	6
PTP-20A	Amber	20 Oz	Doz	2
PTP-20B	Blue	20 Oz	Doz	2
PTP-20C	Clear	20 Oz	Doz	2
PTP-20R	Red	20 Oz	Doz	2
PTP-24A	Amber	24 Oz	Doz	2
PTP-24B	Blue	24 Oz	Doz	2
PTP-24C	Clear	24 Oz	Doz	2
PTP-24R	Red	24 Oz	Doz	2
PTP-32A	Amber	32 Oz	Doz	2
PTP-32B	Blue	32 Oz	Doz	2
PTP-32C	Clear	32 Oz	Doz	2
PTP-32R	Red	32 Oz	Doz	2

**PLASTIC DRINKWARE**



PTSN-SERIES

**NSF**

**BPA FREE**



PTP-SERIES-COLORS



PTP-SERIES



## ELECTRIC COFFEE WARMERS



ECW-1



ECW-2S



ECW-2

SEE PAGE 385  
FOR COFFEE  
URNS



ECW-SERIES

## ELECTRIC COFFEE WARMERS

Keep coffee fresh, hot and ready to serve at the optimal serving temperature. Coffee warmers are ideal for any self-service area.

- ◆ Space-saving, low-profile for maximum product visibility
- ◆ Durable stainless steel body with ceramic-coated plates
- ◆ Lighted on/off switch(s)
- ◆ 120V~50/60Hz, 100W per burner
- ◆ One year parts and labor warranty

ITEM	DESCRIPTION	UOM	CASE
ECW-1	Single Burner	Each	1/6
ECW-2	Double Burners	Each	1/6
ECW-2S	Step-Up Double Burner	Each	1

## COFFEE PRESSES



CFI-4

SINGLE-SERVE  
BREWING



FPCM-33

## STAINLESS STEEL VIETNAMESE COFFEE INFUSER

Use this unique press with built-in filter to brew single-serve coffee that's smooth and strong every time.

- ◆ Set includes built-in filter, screw-down press, cover and 3-3/4" wide saucer

ITEM	DESCRIPTION	UOM	CASE
CFI-4	3-3/4"Dia x 2-1/2"H	Each	12/144

## STAINLESS STEEL FRENCH PRESS

- ◆ Can also be used with loose leaf teas
- ◆ Glass carafe approximately 4 cup capacity

ITEM	DESCRIPTION	UOM	CASE
FPCM-33	33 Oz, 3-3/4"Dia	Each	1/12

## COFFEE ACCESSORIES

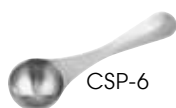

CSP-6



WPE-24



WPE-40



WP-66



CD-64

## COFFEE SCOOP

- ◆ Measures 1 tablespoon; long handle for easy reach
- ◆ Fingerprint-resistant satin finish, 18/8 stainless steel

ITEM	DESCRIPTION	UOM	CASE
CSP-6	6" L	Each	12/288

## STAINLESS STEEL ESPRESSO MILK FROTHING PITCHERS

A coffee-shop necessity, the frothing pitchers feature convenient measurement marks and a wide pouring lip. The bell-shape encourages liquid rotation when steaming or frothing milk.

ITEM	DESCRIPTION	UOM	CASE
WPE-24	24 Oz	Each	1/24
WPE-40	40 Oz	Each	1/24

## STAINLESS STEEL FROTHING PITCHERS

ITEM	DESCRIPTION	UOM	CASE
WP-14	14 Oz	Each	1/48
WP-20	20 Oz	Each	1/48
WP-33	33 Oz	Each	1/36
WP-50	50 Oz	Each	1/24
WP-66	66 Oz	Each	1/24

## STAINLESS STEEL COFFEE SERVER

ITEM	DESCRIPTION	UOM	CASE
CD-64	64 Oz w/Cover	Each	1/12

**COFFEE DECANTERS WITH STAINLESS STEEL BASE**

ITEM	DESCRIPTION	UOM	CASE
CD-64K	64 Oz Regular	Each	1/24
CD-64O	64 Oz Decaf	Each	1/24

**STAINLESS STEEL COFFEE DREDGE KNOCK BOX**

- ◆ 23 gauge; fits any 1/6th size opening

ITEM	DESCRIPTION	UOM	CASE
SCD-5	7"L x 6"W x 5"H	Each	1/24

**COFFEE CLEANING BRUSHES**

ITEM	DESCRIPTION	UOM	CASE
CDB-11	Decanter Brush, 11"L x 1-1/4"W x 1-1/4"H	Each	12/96
BR-25	Equipment Brush, 25"	Each	12/96

**COFFEE ACCESSORIES**



**IN-COUNTER CUP DISPENSER**

Made for fast-food environments and busy self-service stations, this convenient and space-efficient, in-counter cup dispenser utilizes a spring-loaded design to allow for one-at-a-time dispensing in horizontal, angled or vertical mounting positions.

- ◆ Made of durable ABS plastic
- ◆ Designed for cups with rim diameters from 3-1/8" to 4-1/2"
- ◆ Built-in clips allow dispenser to be adjusted without removing from the counter

ITEM	DESCRIPTION	UOM	CASE
CDIC-4	24"L x 5-1/4"Dia	Each	1/9

**CUP DISPENSER, RACKS & ORGANIZERS**



**CUP DISPENSING RACKS**

Keep self-service counters neat and tidy with this economical organizer for paper, plastic or foam cups.

- ◆ Load from front or back; dispenses one at a time
- ◆ Suction feet securely hold dispenser on a flat surface
- ◆ For cups from 8 oz to 44 oz w/rims between 3-1/8" and 4" diameter
- ◆ Available with three (3) or four (4) tiers

ITEM	DESCRIPTION	UOM	CASE
CDR-3	3-Tier	Each	1/2
CDR-4	4-Tier	Each	1/2

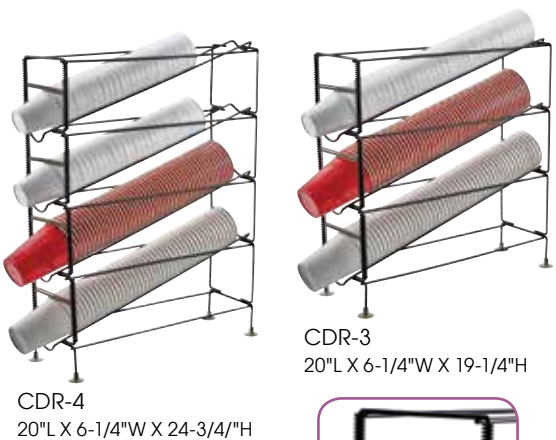

**CUP & LID ORGANIZERS**

The ideal solution for busy self-service stations with limited countertop space. Made of durable, easy to clean ABS plastic. Multi-functional compartments keep cups, lids, condiments and stirrers in their place.

ITEM	DESCRIPTION	UOM	CASE
CLO-2D	2 Tiers & 2 Stacks	Each	1/4
CLO-3D	2 Tiers & 3 Stacks	Each	1/4
CLSO-2T	3 Tiers & 2 Stacks	Each	1/4
CLSO-3T	3 Tiers & 3 Stacks	Each	1/4



CLO-2D 8-1/2"L x 8-5/8"W x 12-1/4"H  
 CLO-3D 12-11/16"L x 8-5/8"W x 12-1/4"H  
 CLSO-2T 8-1/2"L x 13-1/16"W x 12-3/16"H  
 CLSO-3T 12-5/16"L x 12-3/4"W x 13-1/8"H

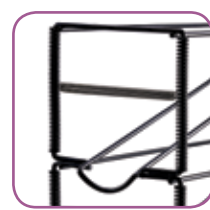

Twist springs on cup rack to adjust for different cup sizes

## DISPLAY TRAYS & RISERS



HRS-4

Made of 18/8 stainless steel, the surfaces of these trays and risers exhibit a glossy ripple effect in gleaming mirror finish, making them truly unique and elegant pieces for showcasing appetizers and desserts.

- ◆ Durable and stable surface for displaying
- ◆ Not recommended for prolonged use with acidic, creamy or salty ingredients
- ◆ Hand wash recommended

### NESTING RISER DISPLAY

- ◆ 4-piece nesting set

ITEM	DESCRIPTION	UOM	CASE
HRS-4	Riser 1: 5-1/2" x 5-1/2" x 5-1/2" Riser 2: 6-5/8" x 6-5/8" x 6-5/8" Riser 3: 7-7/8" x 7-7/8" x 7-7/8" Riser 4: 9" x 9" x 9"	Set	4

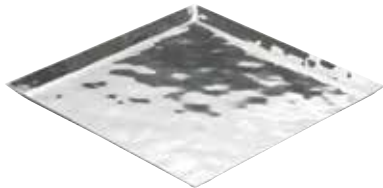

HPS-12

### DISPLAY TRAYS

- ◆ Available in a variety of shapes and sizes

ITEM	DESCRIPTION	UOM	CASE
HPO-14	Rectangular 13-3/4" x 7-3/4" x 1"	Each	12
HPO-15	Rectangular 15" x 8-1/2" x 1"	Each	12
HPS-10	Square 10-1/4" x 10-1/4" x 5/8"	Each	12
HPS-12	Square 11-3/4" x 11-3/4" x 5/8"	Each	12
HPR-8	Round 8-7/8"Dia x 1-5/8"	Each	12
HPR-9	Round 9-5/8"Dia x 1-5/8"	Each	12
HPR-10	Round 10-1/4"Dia x 1-5/8"	Each	12



HPR-10

## DISPLAY BOWLS



DWAB-S

### DOUBLE-WALL ANGLED DISPLAY BOWLS

A perfect mix of form and function, this stainless steel double-wall insulated bowl features indentations to allow for it to stand flat or at an angle.

- ◆ Maintains serving temperature
- ◆ Does not sweat or bead
- ◆ Satin interior disguises scratches
- ◆ Dual option to stand flat or at an angle

ITEM	DESCRIPTION	UOM	CASE
DWAB-S	1-1/2 Qt	Each	1/12
DWAB-L	2-1/4 Qt	Each	1/6



DWAB-L



## SEAFOOD TRAYS

Create an enticing tabletop spread with these trays in assorted sizes for displaying seafood or appetizers. The brushed aluminum construction retains cold and keeps foods at safe serving temperatures.

ITEM	DESCRIPTION	UOM	CASE
ASFT-12	12"Dia x 1-1/2"H	Each	12/36
ASFT-14	13-3/4"Dia x 1-1/2"H	Each	12/36
ASFT-16	15-3/4"Dia x 1-1/2"H	Each	12/24
ASFT-18	17-3/4"Dia x 1-1/2"H	Each	12/24
ASFT-20	19-3/4"Dia x 1-1/2"H	Each	12



### CHROME-PLATED SEAFOOD TRAY RACKS

- ◆ Use with ASFT-series seafood trays to create appealing tabletop presentations
- ◆ Also perfect for elevating serving plates, bowls and platters, as well as holding pizza pans

ITEM	DESCRIPTION	UOM	CASE
SFR-4	7-3/8" Top Dia / 9-5/8" Bottom Dia x 4-3/8"H	Each	20
SFR-7	7-3/8" Top Dia / 9-5/8" Bottom Dia x 7"H	Each	20

## SEAFOOD TRAYS



ASFT-12

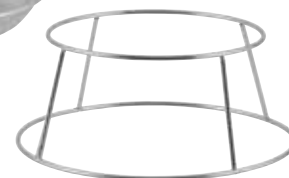

SFR-4



## PEARL SHELL BOWLS

Made of lightweight ABS plastic, these shell bowls are ideal for displaying cold foods and salads.

ITEM	DESCRIPTION	UOM	CASE
PSBW-1W	20 Oz	Each	12/48
PSBW-5W	5 Qt	Each	6/12

### PEBBLED SALAD BOWLS

- ◆ Made of durable polycarbonate, these clear pebbled bowls are perfect for salads, fruits, desserts and snacks
- ◆ NSF listed

ITEM	DESCRIPTION	UOM	CASE
PBB-6	6-3/4"	Each	96
PBB-8	8-3/4"	Each	48
PBB-10	10-3/4"	Each	24
PBB-12	12-3/4"	Each	24
PBB-15	15-3/4"	Each	12
PBB-18	18-3/4"	Each	12

## BOWLS & CROCKS



PSBW-1W

PSBW-5W



PBB-10

PBB-SERIES



CRK-SERIES



## DELI CROCKS

Beautiful fluted finish combined with durable SAN plastic makes these crocks ideal for deli counter and picnic buffet presentations.

- ◆ BPA-free

ITEM	DESCRIPTION	COLOR	UOM	CASE
CRK-10R	10" x 7" x 3"	Red	Each	24
CRK-10K	10" x 7" x 3"	Black	Each	24
CRK-10C	10" x 7" x 3"	Clear	Each	24
CRK-10W	10" x 7" x 3"	White	Each	24
CRK-13R	13" x 10" x 3"	Red	Each	12
CRK-13K	13" x 10" x 3"	Black	Each	12
CRK-13C	13" x 10" x 3"	Clear	Each	12
CRK-13W	13" x 10" x 3"	White	Each	12

### COVERS FOR DELI CROCKS

ITEM	DESCRIPTION	COLOR	UOM	CASE
CRKC-10	Cover for CRK-10 Series	Clear	Each	48
CRKC-13	Cover for CRK-13 Series	Clear	Each	48



CRKC-13

CRKC-10



# ACRYLIC & PLASTIC DISPLAYS



CKS-13

**NSF** CKS-13C, COVER

## CAKE STAND & COVER

- ◆ Assembly required for cake stand and cover
- ◆ Covers available for full case purchase only

ITEM	DESCRIPTION	UOM	CASE
CKS-13	13"Dia Stand, S/S	Set	6/12
CKS-13C	12"Dia Cover, Plastic, NSF	Each	6



ADC-2



ADC-3



ADC-4

## ACRYLIC TIERED DISPLAY CASES

Showcase baked goods and increase impulse purchases with the 2, 3, or 4-tiered display cases. Clear sides all-around allow patrons to view contents and make selections.

- ◆ Efficient use of counter space with vertical display
- ◆ Trays easily slide out for cleaning and restocking
- ◆ Durable, easy to wipe clean construction

ITEM	DESCRIPTION	SIZE (L X D X H)	UOM	CASE
ADC-2	2-Tray, Front & Rear Door	21" x 18" x 12"	Set	1
ADC-3	3-Tray, Rear Door	21" x 18" x 16-1/2"	Set	1
ADC-4	4-Tray, Front & Rear Door	14" x 24" x 24"	Set	1
ADC-TY	Tray for ADC-Series Display Cases	20-1/4" x 13-1/4" x 3/4"	Each	12



ADC-2 & ADC-4 feature handle on front for self-serve option



Trays fit into tracks that are angled up for a better view

### DOME COVERS

- ◆ Made of durable polycarbonate plastic
- ◆ Full-size dome can be used with AST-1S and AST-1G display trays
- ◆ C-DP1 & C-DPF1 fits full-size steam table pans and poly pans
- ◆ C-DP2 & C-DPF2 fits half-size steam table pans and poly pans
- ◆ NSF listed

ITEM	DESCRIPTION	SIZE	UOM	CASE
C-DP1	Full-size Cover	21-1/2" x 13-3/4"	Each	12
C-DP2	Half-size Cover	13-1/2" x 11"	Each	24
C-DPF1	Full-size Flip Cover	21-1/2" x 13-3/4"	Each	12
C-DPF2	Half-size Cut-out Cover	13-1/2" x 11"	Each	24

### ACRYLIC & PLASTIC DISPLAYS



C-DP1



C-DPF1



C-DPF2

DOME COVERS 

### HINGED DOME COVER

- ◆ Polycarbonate
- ◆ Fits full-size steam table pans and poly pans
- ◆ NSF listed

ITEM	DESCRIPTION	SIZE	UOM	CASE
C-DPFH	Full-size Hinged Cover	21" x 13"	Each	12



C-DPFH 

### ACRYLIC TEXTURED DISPLAY TRAYS

Show off decadent pastries and sweets perfectly with the acrylic snake-skin textured display trays in silver or gold.

- ◆ Fits in all above display cases and under dome covers

ITEM	DESCRIPTION	SIZE	UOM	CASE
AST-1S	Silver Tray	20-3/4" x 12-3/4"	Each	24
AST-2G	Gold Tray, Acrylic	20-3/4" x 12-3/4"	Each	24



AST-1S



AST-2G

### ICE CREAM CONE HOLDER

ITEM	DESCRIPTION	SIZE	UOM	CASE
ACN-4	4-Hole Stand	12" x 4" x 4-1/2"	Each	1/12



ACN-4

## ROLL-TOP COVER



C-RCF

### ROLL-TOP COVER

- ◆ 18/8 satin finish stainless steel
- ◆ Fits full-size 12" x 20" opening food pan
- ◆ Plastic handle is heat resistant up to 220°F (105°C)
- ◆ Can be used over standard sized food warmers/cookers

ITEM	DESCRIPTION	UOM	CASE
C-RCF	20-3/4"L x 13"W x 11-7/8"H	Each	1/2



## ANGLED ADAPTOR



ADB-4

### ANGLED DISPLAY ADAPTOR

*Add some dimension to a buffet with an angled display adaptor to give steam table pans a lift so guests have a better view and easier access to food.*

ITEM	DESCRIPTION	UOM	CASE
ADB-4	Full-size, S/S	Each	2/6

## WOVEN BASKET WITH HANDLES



PWBN-16B

### NATURAL WOVEN BASKETS WITH HANDLES

ITEM	DESCRIPTION	UOM	CASE
PWBN-12B	12" x 8" x 3"	Each	12/96
PWBN-16B	16" x 11" x 3"	Each	12/48

## DISPLAY SIGNAGE BOARDS & ACCESSORIES

- ◆ Perfect for bakeries, cafes, coffee shops, pubs and restaurants
- ◆ Made for frequently changing specials, the High-tech Absol-Flat black glossy surface allows for clean and mess-free writing
- ◆ Solid 1-1/4" wide frame with double reinforced joints
- ◆ Durable packaging prevents damage while in transit



### WOODEN FRAME MARKER BOARDS

ITEM #	DESCRIPTION	INCLUDES	SIZE	UOM	CASE
MBB-1	Natural	1 Standard White Marker & Eraser	23-5/8\"L x 3/4\"W x 31-5/8\"H	Set	6
MBB-3	Mahogany	1 Standard White Marker & Eraser	23-5/8\"L x 3/4\"W x 31-5/8\"H	Set	1/6

### DUAL-SIDED SIDEWALK A-FRAME MARKER BOARDS

ITEM #	DESCRIPTION	INCLUDES	SIZE	UOM	CASE
MBAF-1	Natural	4 Standard Markers & Eraser	20-1/4\"L x 2\"W x 39-1/2\"H	Set	1
MBAF-3	Mahogany	4 Standard Markers & Eraser	20-1/4\"L x 2\"W x 39-1/2\"H	Set	1
MBAF-4	Mahogany	4 Standard, 2 Deluxe Plus Markers & Eraser	25\"L x 2\"W x 45\"H	Set	1
MBAF-5	Premium White Oak	2 Standard, 4 Deluxe Plus Markers & Eraser	26\"L x 2\"W x 46\"H	Set	1



### PREMIUM TRIPOD DISPLAY EASEL

- ◆ A stylish lift to the wood frame marker boards
- ◆ Solid, 1" thick wooden frame has two adjustable deluxe planes with pure copper knobs, comes with rubber feet
- ◆ Factory assembled ensures superior stability over knock-down easels

ITEM #	DESCRIPTION	SIZE	UOM	CASE
MBBE-1	Natural	23-1/4\"L x 1\"W x 61\"H	Set	1
MBBE-3	Mahogany	23-1/4\"L x 1\"W x 61\"H	Set	1



MBB-3 AND MBBE-3 GROUP



MBBE-1

### DELUXE NEON MARKERS & ERASER

With floral ink to deliver the most vivid color, the Deluxe Plus markers write on every kind of surface.

ITEM #	DESCRIPTION	SIZE	COLOR	UOM	CASE
MBPM-B	Deluxe Plus	15g Ink, 1/16" Chisel	Neon Blue	Each	72/288
MBPM-G	Deluxe Plus	15g Ink, 1/16" Chisel	Neon Green	Each	72/288
MBPM-O	Deluxe Plus	15g Ink, 1/16" Chisel	Neon Orange	Each	72/288
MBPM-P	Deluxe Plus	15g Ink, 1/16" Chisel	Neon Pink	Each	72/288
MBPM-R	Deluxe Plus	15g Ink, 1/16" Chisel	Neon Red	Each	72/288
MBPM-U	Deluxe Plus	15g Ink, 1/16" Chisel	Neon Purple	Each	72/288
MBPM-W	Deluxe Plus	15g Ink, 1/16" Chisel	Neon White	Each	72/288
MBPM-Y	Deluxe Plus	15g Ink, 1/16" Chisel	Neon Yellow	Each	72/288
MBM-B	Standard	12g Ink, 1/4" Bullet	Neon Blue	Each	72/288
MBM-G	Standard	12g Ink, 1/4" Bullet	Neon Green	Each	72/288
MBM-P	Standard	12g Ink, 1/4" Bullet	Neon Pink	Each	72/288
MBM-R	Standard	12g Ink, 1/4" Bullet	Neon Red	Each	72/288
MBM-W	Standard	12g Ink, 1/4" Bullet	Neon White	Each	72/288
MBM-Y	Standard	12g Ink, 1/4" Bullet	Neon Yellow	Each	72/288
MB-E	Easy Wipe Eraser			Each	72/288



Deluxe Plus Broad Chisel Tip Markers



Standard Bullet Tip Markers



MB-E



DELUXE PLUS SERIES

STANDARD SERIES



## CONDIMENT CADDIES



CDP-5



**NSF** CCH-6



CCH-6IS



CCH-4IS



BC-4P



**NSF**  
**BPA FREE** BC-6

## STAINLESS STEEL CONDIMENT HOLDERS

ITEM	DESCRIPTION	UOM	CASE
CDP-4	4 Compartments	Each	1/16
CDP-5	5 Compartments	Each	1/16
CDP-6	6 Compartments	Each	1/16
CDP-1P	1pt Insert for CDP-4/5/6	Each	120
CDP-1Q	1qt Insert for CDP-4/5/6	Each	60

*There is no space for ice under the compartments.*

## PLASTIC BASE CONDIMENT HOLDERS

- ◆ Durable ABS holder with lid & removable food-grade poly inserts
- ◆ Perfect for storing garnish
- ◆ Dishwasher safe

ITEM	DESCRIPTION	SIZE	UOM	CASE
CCH-4	4 Compartments, Black, NSF	19-3/8" x 6-1/4" x 3-3/4"	Each	1/6
CCH-6	6 Compartments, Black, NSF	19-7/16" x 6-1/4" x 3-1/2"	Each	1/6
CCH-4IS	Inserts for CCH-4, 4-Pcs/Pk		Pack	24
CCH-6IS	Inserts for CCH-6, 6-Pcs/Pk		Pack	24
BC-4P	4 Compartments, White	18" x 5" x 3"	Set	6/36

*There is no space for ice under the compartments.*



## BAR CADDY

- ◆ BPA-free, NSF listed

ITEM	DESCRIPTION	UOM	CASE
BC-6	6 Compartments, Plastic	Each	12

### DECORATIVE BAMBOO PICKS

Artfully arrange hor d'oeuvres for a stylish presentation. Use with burgers and sandwiches. Garnish martinis and cocktails with style and ease.

- ◆ Knotted end allows easy pick-up of individual portions
- ◆ Variety of uses: arrange appetizers, hold finger-foods, garnish beverages
- ◆ Biodegradable

ITEM	DESCRIPTION	SIZE	PCS/BAG	UOM	CASE
PK-KT3	Bamboo	3"	100	Bag	12/120
PK-KT4	Bamboo	4"	100	Bag	12/120
PK-KT7	Bamboo	7"	100	Bag	12/120



100 pieces per hanging bag



PK-KT7 PK-KT4 PK-KT3

NEW

### DECORATIVE PICKS

- ◆ Available in a variety of styles and colors
- ◆ Easily displayed with hanging packaging

ITEM	DESCRIPTION	SIZE	PCS/BAG	UOM	CASE
PK-P4	Parasol	3-15/16"	144	Bag	100
PK-C2	Cellophane Frills	2-9/16"	1,000	Bag	10
PK-C4	Cellophane Frills	3-15/16"	1,000	Bag	10
PK-A35	Plastic Arrow	3-7/16"	500	Bag	20
PK-S3	Plastic Sword	2-3/4"	500	Bag	20



PK-S3



PK-A35



PK-C4

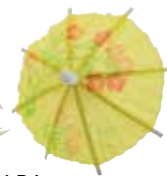

PK-P4



PK-C2

### STAINLESS STEEL DRINKING STRAWS

- ◆ 18/8 stainless steel
- ◆ Reusable, environmentally-friendly
- ◆ Each straw measures 1/4"Dia x 8-1/2"H
- ◆ 5-piece set includes four (4) straws and one (1) cleaning brush
- ◆ Dishwasher safe

ITEM	DESCRIPTION	UOM	CASE
SSTW-8C	Curved	Set	12/48
SSTW-8S	Straight	Set	12/48

### STAINLESS STEEL STRAWS

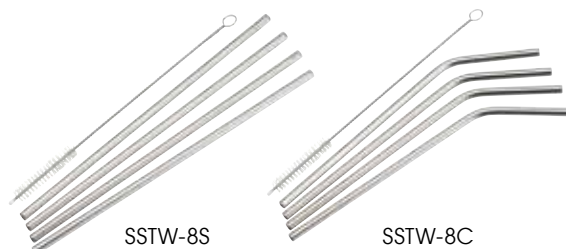

SSTW-8S

SSTW-8C

### ACRYLIC STRAW DISPENSER

- ◆ Capacity 250 straws; fits up to 10" long straws
- ◆ BPA-free

ITEM	DESCRIPTION	UOM	CASE
ACSD-712	10-3/4" x 4-3/4" x 7"	Each	6

### STRAW DISPENSERS



ACSD-712

BPA FREE

### SAN PLASTIC VERTICAL STRAW DISPENSER

- ◆ Clear, break-resistant SAN plastic cylinder
- ◆ Stainless steel pull-up lid and dispenser insert
- ◆ Capacity 100 straws
- ◆ BPA-free

ITEM	DESCRIPTION	UOM	CASE
SDP-3	3-3/8"Dia x 10-3/4"H	Each	1/12



SDP-3

BPA FREE

## MOSCOW MULE MUGS



CMM-20

CMM-20H



CMM-2

CMM-2H



## COPPER-PLATED MOSCOW MULE MUGS

Whether serving its classic namesake drink or any refreshing cocktail, these rustic copper-plated mugs will instantly keep drinks extra cold, making them great additions to an outdoor bar setting.

ITEM	DESCRIPTION	CAPACITY	UOM	CASE
CMM-20	Smooth	20 Oz	Each	36
CMM-20H	Hammered	20 Oz	Each	36



## MINI MOSCOW MULE MUGS

The popular Moscow Mule Mugs are now available in mini versions!

- ◆ Great for sauces
- ◆ 4-Pcs/Set

ITEM	DESCRIPTION	CAPACITY	UOM	CASE
CMM-2	Smooth	2 Oz	Set	6/24
CMM-2H	Hammered	2 Oz	Set	6/24

## MINT JULEP CUPS



DDSE-101S

DDSE-102S



## STAINLESS STEEL MINT JULEP CUPS

ITEM	DESCRIPTION	CAPACITY	UOM	CASE
DDSE-101S	3" Dia x 4-3/8"H	12 Oz	Each	12/72
DDSE-102S	3-3/8" Dia x 4-3/4"H	15 Oz	Each	12/72

## MIXING GLASS



WG10-001

## MIXING GLASS

- ◆ 24-Pcs/Case

ITEM	DESCRIPTION	CAPACITY	UOM	CASE
WG10-001	Clear	16 Oz	Case	1

## SHAKERS



BS-310

BS-3P

BL-28P

BS-1P

BL-3P

BS-3B



## BAR SHAKER SETS

- ◆ Stainless steel
- ◆ 3-pc sets include cap, strainer and cup

ITEM	DESCRIPTION	CAPACITY	UOM	CASE
BS-310	Classic 3-Pc Set	10 Oz	Each	12/48
BS-1P	Classic 3-Pc Set	16 Oz	Each	1/24
BS-3P	Classic 3-Pc Set	28 Oz	Each	1/12
BL-3P	Deluxe 3-Pc Set	16 Oz	Each	1/24
BL-28P	Deluxe 3-Pc Set	28 Oz	Each	1/12
BS-3B	Beehive 3-Pc Set	24 Oz	Each	1/24



## CLEAR BAR SHAKER

ITEM	DESCRIPTION	CAPACITY	UOM	CASE
BS-16PC	Clear Bar Shaker	16 Oz	Each	1/24



BS-16PC

BS-15

BS-30

MCP-30

BS-28P

## BAR SHAKER CUPS

- ◆ Stainless steel

ITEM	DESCRIPTION	CAPACITY	UOM	CASE
BS-15	Shaker Cup	15 Oz	Each	12/144
BS-30	Shaker Cup	30 Oz	Each	12/72
MCP-30	Malt Cup	30 Oz	Each	12/72
BS-28P	PVC Exterior	28 Oz	Each	24/48



**JAPANESE-STYLE JIGGERS**

- ◆ Stainless steel
- ◆ Rolled rim for easy pour and a high-end look

ITEM	DESCRIPTION	UOM	CASE
J-6	1/2 Oz x 3/4 Oz	Each	12/300
J-7	1/2 Oz x 1 Oz	Each	12/300
J-8	1 Oz x 1-1/4 Oz	Each	12/300
J-9	1 Oz x 2 Oz	Each	12/300

**STANDARD JIGGERS**

- ◆ Stainless steel
- ◆ Flip sides for different capacity measures

ITEM	DESCRIPTION	UOM	CASE
J-1	1/2 Oz x 1 Oz	Each	12/300
J-2	3/4 Oz x 1-1/4 Oz	Each	12/300
J-3	3/4 Oz x 1-1/2 Oz	Each	12/300
J-4	1 Oz x 1-1/2 Oz	Each	12/300
J-5	1 Oz x 2 Oz	Each	12/300

**DRINK PREP TOOLS**



J-9



J-1



J-3

**BAR ACCESSORIES**

- ◆ Stainless steel

ITEM	DESCRIPTION	UOM	CASE
BPS-11	11" Bar Spoon	Each	24/600
BST-4P	Hawthorne Strainer	Each	12/288
JST-1	Julep Strainer	Each	12/240

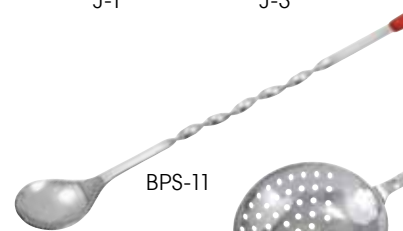

BPS-11



BST-4P



JST-1



MS2K-3S



**STRAINER-SIFTER**

Add an extra twist of citrus right into a cocktail with this 3" strainer. The fine mesh is great for catching pulp and small seeds.

- ◆ Stainless steel

ITEM	DESCRIPTION	UOM	CASE
MS2K-3S	3"Dia x 8"L x 1"H	Each	24/144



**BEER LAYERING SPOON**

A must-have for making black & tans or half & halves, the specially designed ridge of this spoon rests over the lip of the glass to allow for that essential slow pour, creating flawlessly layered beers.

ITEM	DESCRIPTION	UOM	CASE
BLS-6	1-5/8" Dia, S/S	Each	12/48



Beer layering



BLS-6



**GLASS RIMMERS**

ITEM	DESCRIPTION	UOM	CASE
GR-2	2-Tier, Plastic w/Sponge	Each	1/12
GR-3	3-Tier, Plastic w/Sponge, NSF	Each	1/12
GR-3S	Replacement Sponge, No Retail Packaging	Each	12/144



GR-2



GR-3S



GR-3



## BOTTLE OPENERS



CO-301



CO-301PK



CO-301PB



CO-301PR



CO-402



CO-401

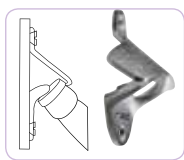

CO-402 In use, side view



BCH-14

## FLAT BOTTLE OPENERS

◆ Stainless steel

ITEM	DESCRIPTION	UOM	CASE
CO-301	Without Coating	Each	12/144
CO-301PB	Blue PVC Coating	Each	12/144
CO-301PK	Black PVC Coating	Each	12/144
CO-301PR	Red PVC Coating	Each	12/144

## UNDER-COUNTER STAINLESS STEEL BOTTLE OPENER

ITEM	DESCRIPTION	UOM	CASE
CO-401	4-1/4"	Each	24/288



## WALL-MOUNT BOTTLE OPENER

*Ideal for busy bars where searching for hand-held bottle openers is not an option. Can be mounted to walls or bar counter fixtures.*

- ◆ Made of sturdy die-cast zinc alloy
- ◆ Wall-mounted for easy accessibility
- ◆ Includes mounting screws

ITEM	DESCRIPTION	UOM	CASE
CO-402	3-1/4"L x 2-3/4"W	Each	24/144

## BOTTLE CAP CATCH

ITEM	DESCRIPTION	UOM	CASE
BCH-14	5-1/2"L x 3-1/2"W x 13-3/4"H	Each	1/24

## CORKSCREWS



CO-501



CO-701



CO-511



CO-512



CO-711



CO-712



CO-4DK

CO-4DW



CO-4DK assembled

## WING-STYLE CORKSCREWS



ITEM	DESCRIPTION	UOM	CASE
CO-501	Wing Type, Chrome	Each	12/144
CO-701	Wing Type, Black	Each	12/72



CO-720

**DOUBLE-HINGED FOR EFFORTLESS CORK REMOVAL**



CO-720 double-hinged corkscrew in use

## CORKSCREWS



ITEM	DESCRIPTION	UOM	CASE
CO-720	Double-Hinged Corkscrew	Each	6/96
CO-511	Waiter's Corkscrew, S/S, Made in Italy (No Retail Pkg)	Each	12/144
CO-512	Waiter's Corkscrew, Black, Made in Italy (No Retail Pkg)	Each	12/144
CO-711	Waiter's Corkscrew, S/S, Economy	Each	12/144
CO-712	Waiter's Corkscrew, Black, Economy	Each	12/144
CO-4DK	Black, 2-Sets/Pk	Pack	24/96
CO-4DW	White, 2-Sets/Pk	Pack	24/96

**TWIST & OUT™ CHROME-PLATED CAN OPENERS**

- ◆ Soft-grip handle helps to reduce hand fatigue while providing leverage when turning the crank
- ◆ Smooth cutting blade makes all day prep easier
- ◆ Durable frame, handles #10 cans with ease

ITEM	DESCRIPTION	UOM	CASE
CO-901	7"L, Easy-Turn Handle	Each	12/48
CO-902	8-3/4"L, Crank Handle	Each	12/48



Twist & Out™ hanging packaging



Front gears Back handle

CO-901



Front gears Back handle

CO-902

**CAN OPENER**

- ◆ Made in Italy

ITEM	DESCRIPTION	UOM	CASE
CO-530	White Handles	Each	12/72



CO-530

**CAN TAPPER/BOTTLE OPENER**

ITEM	DESCRIPTION	UOM	CASE
CO-201	Nickel Plated, 4"	Each	100/600
CO-302	Stainless Steel, 7"	Each	12/144
CO-303	Wooden Hdl, S/S, 7"	Each	12/144



CO-302

CO-201



CO-303

**GARNISH CUTTING BOARDS**

**STATIK BOARD™ GARNISH CUTTING BOARD**

Molded through non-slip feet hold firm, even when wet. The tough surface reduces knife dulling and durable copolymer material prevents warping.

- ◆ Dishwasher safe
- ◆ BPA Free
- ◆ NSF Listed

ITEM	DESCRIPTION	UOM	CASE
CBN-610WT	6" x 10" x 1/2"	Each	20



**STATIKboard™**



CBN-610WT

NSF

BPA FREE

**GARNISH CUTTING BOARD**

- ◆ NSF listed

ITEM	DESCRIPTION	UOM	CASE
CBWT-610	6" x 10" x 1/2"	Each	20



CBWT-610

NSF

**MUDDLERS & SQUEEZERS**



JC-19



SBM-8N



WMW-8



PBM-8N



PBM-8T



MPS-42W



JC-4



LS-3

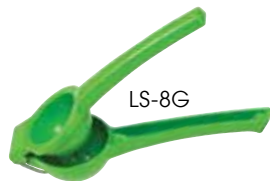

LS-8G



LS-9Y



LS-9O



**HAND PRESS CITRUS JUICER**

*These manual citrus press extract juice from fresh fruits with ease, maximizing yield by squeezing out every last drop. The strainer catches seeds and pulp while fresh-squeezed juice pours into the cup below.*

- ◆ Sturdy, reinforced base with rubber feet prevent sliding
- ◆ Strong steel post support and smooth lever action
- ◆ Ideal for medium to small citrus fruits

ITEM	DESCRIPTION	UOM	CASE
JC-19	Premium, 19"	Each	1/2

**MUDDLERS**

- ◆ 8" long



ITEM	DESCRIPTION	UOM	CASE
SBM-8N	Netted Head, S/S	Each	12/96
WMW-8	Flat Head, Wooden	Each	24/144
PBM-8N	Netted Head, PC	Each	12/216
PBM-8T	Triangular Head, PC	Each	12/216



**MARBLE MORTAR & PESTLE SET**

ITEM	DESCRIPTION	UOM	CASE
MPS-42W	4-1/2"Dia Bowl	Set	1/12



**STAINLESS STEEL MANUAL CITRUS JUICER**

ITEM	DESCRIPTION	UOM	CASE
JC-4	5"Dia	Each	24

**STAINLESS STEEL LEMON/LIME SQUEEZER**

ITEM	DESCRIPTION	UOM	CASE
LS-3	6"Dia	Each	12/144



**HANDHELD CITRUS SQUEEZERS**

*Extract all the juice without the rind, pulp or seeds.*

- ◆ Aluminum with baked-on enamel coating
- ◆ Place citrus half with the cut side down in juicer and extract
- ◆ Dishwasher safe, long lasting, won't absorb odors, and resistant to moisture, heat and stains

ITEM	DESCRIPTION	UOM	CASE
LS-8G	2-1/2"Dia, 8"L	Each	6/48
LS-9Y	3"Dia, 8-3/4"L	Each	6/48
LS-9O	3-1/2"Dia, 9-1/8"L	Each	9/36

High-performance motor with impact-resistant stainless steel blades adds power and performance to your busy establishment.

## ACCELMIX™ BLENDERS

**ACCELMIX™**

by Winco®

### 68 OZ (2 L) LARGE CAPACITY COMMERCIAL BLENDER

- ◆ 68 oz (2 L), break-resistant and BPA-free Tritan™ container
- ◆ High-performance 2 hp motor; unique high-impact blades
- ◆ Metal-to-metal coupling; easy to operate "PULSE" and
- ◆ "ON /OFF" paddle controls & variable speed control dial
- ◆ Container/pitcher is heat-resistant up to 226°F (108°C); reduce pressure by removing cap in the lid
- ◆ Removable container cover and cap for adding/blending ingredients mid-cycle
- ◆ 11-1/2" tamper included - fits through lid opening and reaches full length of container to blend/stir while mixing
- ◆ All parts (except bases & blade fixing block) are dishwasher safe
- ◆ One year parts and labor warranty

OVERALL DIMENSIONS			POWER	PLUG	SHIP WEIGHT
WIDTH	DEPTH	HEIGHT			
8-11/16" (220mm)	9-13/16" (249mm)	19-5/16" (490mm)	120V~60Hz, 1450W, 12.1A	NEMA 5-15P	10.36 lbs (4.7 kgs)
CONTAINER DIMENSIONS					
WIDTH	DEPTH	HEIGHT			
6-11/16" (178mm)	6-11/16" (178mm)	12-3/8" (314mm)			

ITEM	DESCRIPTION	UOM	CASE
▶ XLB-1000	Accelmix™ 68 Oz Blender	Set	1/4
▶ XLB1000P1	Rod Set	Each	1
▶ XLB1000P2	Pitcher Assembly	Each	1
▶ XLB1000P4	Refilling Cap	Each	1
▶ XLB1000P5	Blade Assembly	Each	1
▶ XLB1000P10	Mushroom Head Fitting	Each	1
▶ XLB1000P11	68 oz Pitcher	Each	1
▶ XLB1000P19	Blade Removal Tool	Each	1



Blend fruits, ice and a variety of other ingredients

**XLB-1000 NOW INCLUDES BLADE REMOVAL TOOL**



XLB1000P19

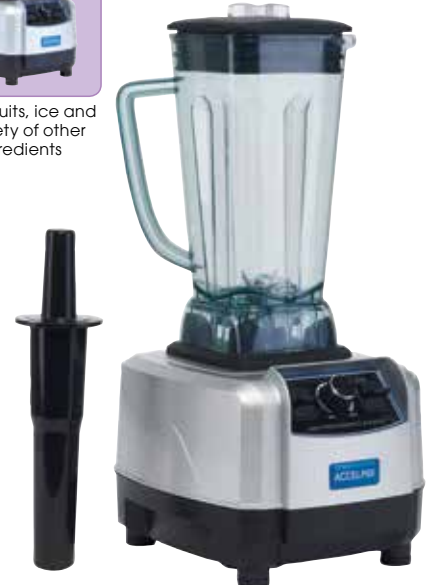

XLB-1000  

TRITAN™ CONTAINER 

### 44 OZ (1.25 L) 2-SPEED QUIET BAR BLENDER

- ◆ 44 oz (1.25 L), break-resistant and BPA-free Tritan™ container
- ◆ Quiet, high-performance 1/2 hp self-lubricating motor; uniquely designed high-impact blades
- ◆ HIGH/LOW toggle switch for precise consistency control
- ◆ Blade is removable for easy cleaning
- ◆ Non-skid feet securely grip the surface for stable operation
- ◆ Removable container cover and cap for adding/blending ingredients mid-cycle
- ◆ One year parts and labor warranty

OVERALL DIMENSIONS			POWER	PLUG	SHIP WEIGHT
WIDTH	DEPTH	HEIGHT			
7" (178mm)	7-7/16" (189mm)	15-7/16" (392mm)	120V~60Hz, 400W, 3.5A	NEMA 5-15P	5.51 lbs (2.5 kgs)
CONTAINER DIMENSIONS					
WIDTH	DEPTH	HEIGHT			
7" (178mm)	5-1/8" (130mm)	9-1/4" (235mm)			

ITEM	DESCRIPTION	UOM	CASE
▶ XLB-44	Accelmix 44 Oz Blender	Set	1/4
▶ XLB44-P1	Filler Cap	Each	1
▶ XLB44-P2	Container Lid	Each	1
▶ XLB44-P3	44 oz Pitcher	Each	1
▶ XLB44-P4	Gasket	Each	1
▶ XLB44-P5	Blade Assembly	Each	1
▶ XLB44-P6	Collar	Each	1
▶ XLB44-P7	Clutch	Each	1
▶ XLB44-P10	Pitcher Assembly	Each	1



**ADD POWER & PERFORMANCE TO YOUR BAR**

XLB-44  

TRITAN™ CONTAINER 

## ICE CUBE TRAYS



ICCT-4R



ICCT-8R



2-piece tray

BPA FREE

ICCP-6W



## ICE CUBE TRAYS

These silicone trays make large 2" cubes of ice and keep drinks chilled longer than the typical ice cube.

- ◆ Silicone material for easy removal
- ◆ Cubes also fit any standard Whiskey glass

ITEM	DESCRIPTION	UOM	CASE
ICCT-4R	4-Cube Tray	Each	12/72
ICCT-8R	8-Cube Tray	Each	12/72



## ROUND ICE CUBE TRAY

Extend the chill with large round ice spheres that are proven to melt slower than standard-size ice cubes.

- ◆ Made of sturdy, stackable polypropylene
- ◆ Makes six (6) perfectly spherical 2" cubes
- ◆ 2-piece top and bottom tray for easy filling; stackable
- ◆ BPA-free

ITEM	DESCRIPTION	UOM	CASE
ICCP-6W	6-Cube Tray	Each	12/72



## ICE TOOLS



ICH-1



ICH-9



ICT-7



ICT-7 Texture



IT-7



IS-4



NSF PS-5

## ICE PICK

- ◆ Nickered Steel and wooden handle

ITEM	DESCRIPTION	UOM	CASE
ICH-1	9"L	Each	24/144

## ICE CHIPPER

- ◆ 6-prong nickeler steel with wooden handle

ITEM	DESCRIPTION	UOM	CASE
ICH-9	9"L, Six Prong	Each	12/120

## ICE TONGS

- ◆ Stainless Steel



ITEM	DESCRIPTION	UOM	CASE
ICT-7	7"L, Five Prong, Textured	Each	12/144
IT-7	7"L, Three Prong, Satin Finish	Each	12/120

## STAINLESS STEEL ICE SCOOP

ITEM	DESCRIPTION	UOM	CASE
IS-4	4 Oz	Each	12/144

## POLYCARBONATE SCOOP

- ◆ NSF listed

ITEM	DESCRIPTION	UOM	CASE
PS-5	5 Oz	Each	24/144

**MANUAL ICE CRUSHER**

Easily make coarse or fine ice chips for cool drinks, as well as ice beds for shellfish.

ITEM	DESCRIPTION	UOM	CASE
ICP-9	6" x 4-7/8" x 9-1/2"H	Each	1/12

**ICE CRUSHER**



ICP-9



**"ICE ONLY" STORAGE CONTAINERS**

- ◆ NSF listed
- ◆ BPA-free

ITEM	DESCRIPTION	UOM	CASE
FCW-10ICE	10 Gal "Ice Only" Container	Each	1/6
FCW-20ICE	20 Gal "Ice Only" Container	Each	1/6
FCW-10L	Lid for FCW-10ICE	Each	1/24
FCW-20L	Lid for FCW-20ICE	Each	1/12

**ICE ONLY CONTAINERS**



FCW-10ICE



FCW-10L



FCW-SERIES



**INSULATED ICE CADDY**

- ◆ Can be used inside or outdoors, in hot or humid conditions
- ◆ Drain shelf keeps ice separate from the water, greatly increasing storage time
- ◆ Polyethylene molded body is durable and light-weight, top lid slides open
- ◆ Polyurethane foam insulation effectively keeps ice cold for several days
- ◆ Recessed front handle for convenient pulling or lifting
- ◆ No assembly required; oil caster wheel bearings before use
- ◆ 125 lb capacity
- ◆ NSF listed

**INSULATED ICE CADDY**



IIC-29

IIC-SERIES



ITEM	DESCRIPTION	SIZE	UOM	CASE
IIC-29	Ice Caddy w/Sliding Lid	Ext Dim: 23"L x 31.5"W x 29.25"H	Set	1
IIC-C8	Caster For IIC-29	8"Dia	Each	1
IIC-C5B	Brake Caster for IIC-29	5"Dia	Each	1



POURERS



PPA-SERIES



Screened pouring spout for added protection

PP-SERIES



PPR-2-SERIES



PPR-1



MEASURED POURERS

Measured pourers can reduce liquor costs up to 30% by preventing over-pouring. The premium measured pourers by Winco® provide a fast and accurate pour, every time.

- ◆ Color-coded for portion control
- ◆ Also for use with juice or oils
- ◆ New and improved over previous PPOK-series

ITEM	DESCRIPTION	UOM	CASE
PPA-050	1/2 Oz, Orange Tail	Doz	25
PPA-063	5/8 Oz, Black Tail	Doz	25
PPA-075	3/4 Oz, Green Tail	Doz	25
PPA-087	7/8 Oz, Blue Tail	Doz	25
PPA-100	1 Oz, Red Tail	Doz	25
PPA-113	1-1/8 Oz, Purple Tail	Doz	25
PPA-125	1-1/4 Oz, Clear Tail	Doz	25
PPA-150	1-1/2 Oz, Yellow Tail	Doz	25
PPA-200	2 Oz, White Tail	Doz	25



SCREENED POURERS

- ◆ Screened spout keeps bugs and dirt out of bottle
- ◆ Spout is bent at the angle to achieve a perfect pour
- ◆ Available in three (3) colors

ITEM	DESCRIPTION	UOM	CASE
PP-SAM	Gemstone Amber	Doz	12/48
PP-SCL	Crystal Clear	Doz	12/48
PP-SSM	Midnight Smoke	Doz	12/48



ECONOMY FREE-FLOW POURERS

- ◆ Color-coded to help with memorization of drink recipes

ITEM	DESCRIPTION	UOM	CASE
PPR-2B	Blue	Doz	12/72
PPR-2C	Clear	Doz	12/72
PPR-2G	Green	Doz	12/72
PPR-2K	Black	Doz	12/72
PPR-2R	Red	Doz	12/72
PPR-2W	White	Doz	12/72
PPR-2Y	Yellow	Doz	12/72

FLEXIBLE PLASTIC POURER

ITEM	DESCRIPTION	UOM	CASE
PPR-1	Black	Each	12/120



**CLASSIC CHROME POURERS**

- ◆ Chrome spout
- ◆ Fast flow with plastic breather tube
- ◆ Food-grade poly-plastic cork

ITEM	DESCRIPTION	UOM	CASE
PP-C	Black Collar	Doz	12/48
PP-NC	No Collar	Doz	12/48

**CLASSIC METAL POURERS**

- ◆ Stainless steel breather tube and different pourer opening sizes provide various flow speeds
- ◆ Food-grade poly-plastic cork

ITEM	DESCRIPTION	UOM	CASE
PPM-4	Tapered Spout, Med Flow	Doz	12/48
PPM-4C	Tapered Spout with Hinged Cap, Med/Fast Flow	Doz	12/48
PPM-4G	Gooseneck Spout, Fast Flow	Doz	12/48
PPM-4J	Jet Spout, Extra Fast Flow	Doz	12/48

**OVERSIZED METAL POURER**

- ◆ Stainless steel breather tube
- ◆ For use with 1.75 Liter, 1/2 gallon and gallon bottles
- ◆ Food-grade poly-plastic cork

ITEM	DESCRIPTION	UOM	CASE
PPM-6	Oversized Tapered Spout, Med Flow	Doz	12/48



**POURERS**



**UNIVERSAL LIQUOR POURER COVER**

- ◆ NSF listed

ITEM	DESCRIPTION	UOM	CASE
PC-1	Flexible Plastic	Doz	48

**UNIVERSAL LIQUOR POURER COVER**



**CHAMPAGNE BOTTLE STOPPER**

- ◆ Keep the fizz and flavor in opened bottles
- ◆ Chrome-coated steel

ITEM	DESCRIPTION	UOM	CASE
CBS-1	1-3/8" Dia	Each	72/288

**BOTTLE STOPPERS**

**WINE BOTTLE STOPPERS**

- ◆ Color-coded collars to match various alcohols
- ◆ Stainless steel clip and food-grade thermoplastic cork

ITEM	DESCRIPTION	UOM	CASE
WBS-R	Red Collar	Doz	12/48
WBS-W	White Collar	Doz	12/48



## POUR BOTTLES



PPB-SERIES



PPB-1B



PFBT-11W

### LIQUOR & JUICE MULTI-POUR SETS

◆ Six (6) color assortments; two (2) of each color per case

ITEM	DESCRIPTION	UOM	CASE
PPB-1MX	1 Qt	Case	1
PPB-2MX	2 Qt	Case	1

### LIQUOR & JUICE MULTI-POUR BOTTLES

◆ Each comes with spout & lid

ITEM	DESCRIPTION	UOM	CASE
PPB-1B	1 Qt, Brown	Each	12
PPB-1G	1 Qt, Green	Each	12
PPB-1O	1 Qt, Orange	Each	12
PPB-1R	1 Qt, Red	Each	12
PPB-1W	1 Qt, White	Each	12
PPB-1Y	1 Qt, Yellow	Each	12
PPB-2B	2 Qt, Brown	Each	12
PPB-2G	2 Qt, Green	Each	12
PPB-2O	2 Qt, Orange	Each	12
PPB-2R	2 Qt, Red	Each	12
PPB-2W	2 Qt, White	Each	12
PPB-2Y	2 Qt, Yellow	Each	12

### PLASTIC FLAIR BOTTLE

ITEM	DESCRIPTION	UOM	CASE
PFBT-11W	12-1/2"H	Each	4/24

## PUMP KIT FOR SYRUPS & LIQUEURS

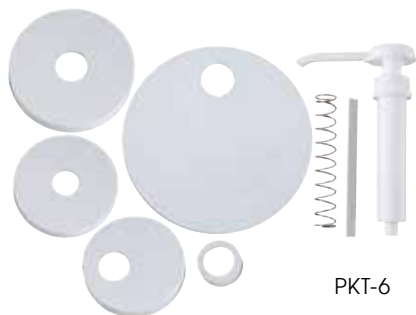

PKT-6



### PLASTIC PUMP KIT FOR SYRUP & LIQUEURS

- ◆ Use for dispensing products such as ketchup, mustard, tartar sauce, dressing, etc.
- ◆ Includes 9" standard size pump
- ◆ 5 lid sizes:
  - 1-9/16" threaded
  - 3-11/16" threaded
  - 4-1/2" threaded
  - 4-1/2" snap on
  - 6-5/16" snap on

ITEM	DESCRIPTION	UOM	CASE
PKT-6	White Pump Kit	Set	12/72

## SPEED RAILS



SPR-22D



SPR-22S



SPR-1



### BAR SPEED RAILS

- ◆ Keep the most frequently used bar liquors and drink mixes close at hand
- ◆ Stainless steel
- ◆ Mounting straps sold separately

ITEM	DESCRIPTION	UOM	CASE
SPR-22S	22" Single	Each	1
SPR-22D	22" Double	Each	1/3
SPR-32S	32" Single	Each	1
SPR-32D	32" Double	Each	1/3
SPR-42S	42" Single	Each	1
SPR-42D	42" Double	Each	1/3
SPR-1	Mounting Straps for SPR-series	Each	12/120

## WINE SERVICE

### STAINLESS STEEL DOUBLE WALL WINE COASTERS

- ◆ Great space saving alternative to wine buckets
- ◆ Can also be used to display light snacks, hors d'oeuvres or desserts on tabletops
- ◆ Satin finish, smooth or hammered
- ◆ Fits 3-3/4" diameter bottles

ITEM	DESCRIPTION	SIZE	UOM	CASE
DWCC-5	Smooth Finish	4-5/8" Dia x 2-5/8"H	Each	12
DWCC-5H	Hammered Finish	4-5/8" Dia x 2-5/8"H	Each	12



DWCC-5H



DWCC-5

### 4 QT STAINLESS STEEL WINE BUCKETS & STAND

- ◆ Mirror finish

ITEM	DESCRIPTION	SIZE	UOM	CASE
WB-4	4 Qt Wine Bucket, (No Retail Pkg)	7-1/2" Dia x 8" H	Each	6/24
WB-4HV	4 Qt Deluxe Wine Bucket	8" Dia x 10" H	Each	1/12
WB-29S	Pipe Style Stand for WB-4 & WB-4HV	28-1/2" H	Each	1/6



WB-4



WB-4HV



WB-29S

### 8 QT STAINLESS STEEL WINE BUCKET & STANDS

- ◆ Mirror finish

ITEM	DESCRIPTION	UOM	CASE
WB-8	8 Qt Wine Bucket	Each	6/24
WB-8S	Stand* for WB-8	Each	1/12
WB-12FS	Folding Stand for WB-8	Each	1/6

\*Assembly required



WB-12FS  
Folded



WB-12FS  
OPEN



WB-8 & WB-8S

### WINE COOLERS

ITEM	DESCRIPTION	SIZE	UOM	CASE
WC-60	Double Wall Hourglass, Mirror S/S	6" Dia x 7" H	Each	1/12
WC-7M	Marble, White	4 1/2" Dia x 7" H	Each	1/6
WC-5	Double Wall, Satin S/S (No Retail Pkg)	4 1/2" Dia x 7-3/4" H	Each	6/24
WC-4A	Acrylic, Clear	4 1/2" Dia x 9 1/4" H	Each	1/12



WC-60



WC-7M



WC-5



WC-4A

### STAINLESS STEEL DOUBLE WALL ICE BUCKET

*Subtle and stylish, this double-walled stainless steel ice bucket prevents condensation and maintains interior temperatures to keep ice colder for longer time periods.*

- ◆ Ideal for hotel rooms
- ◆ Convenient carrying handle and cover

ITEM	DESCRIPTION	UOM	CASE
ICB-60	60 Oz Capacity	Each	1/8



ICB-60

## BAR TRAYS



STRS-16

## ROUND SERVICE TRAYS

Made of highly polished stainless steel, these round trays feature a whimsical swirl design, adding a modern flair to even the most traditional drink presentations.

ITEM	DESCRIPTION	UOM	CASE
STRS-12	12"	Each	12/48
STRS-14	14"	Each	12/24
STRS-16	16"	Each	12/24

## NON-SLIP SERVING TRAYS



### DELUXE FIBERGLASS TRAYS

- ◆ High durability fiberglass tray with self-molded peel-resistant non-slip surface
- ◆ Easy to wash by hand, however not recommended to leave soaking in hot water
- ◆ NSF listed



TFG-16N

TFG-2622K

ITEM	DESCRIPTION	SIZE	COLOR	UOM	CASE
TFG-11K	Round	11"	Black	Each	1/12
TFG-11N	Round	11"	Brown	Each	1/12
TFG-14K	Round	14"	Black	Each	1/12
TFG-14N	Round	14"	Brown	Each	1/12
TFG-16K	Round	16"	Black	Each	1/12
TFG-16N	Round	16"	Brown	Each	1/12
TFG-2622K	Oval	26"x 22"	Black	Each	1/6
TFG-2622N	Oval	26"x 22"	Brown	Each	1/6



TFG FIBERGLASS-SERIES



TRH-16

TRH-2722K

## EASY-HOLD RUBBER-LINED PLASTIC TRAYS

- ◆ NSF listed

ITEM	DESCRIPTION	SIZE	COLOR	UOM	CASE
TRH-11	Round	11"	Brown	Each	12
TRH-11K	Round	11"	Black	Each	12
TRH-14	Round	14"	Brown	Each	12
TRH-14K	Round	14"	Black	Each	12
TRH-16	Round	16"	Brown	Each	12
TRH-16K	Round	16"	Black	Each	12
TRH-1418	Rectangular	18" x 14"	Brown	Each	12
TRH-1418K	Rectangular	18" x 14"	Black	Each	12
TRH-2722	Oval	27" x 22"	Brown	Each	1/6
TRH-2722K	Oval	27" x 22"	Black	Each	1/6



TRH PLASTIC-SERIES



TCK-16

## PLASTIC CORK-LINED TRAYS

ITEM	DESCRIPTION	UOM	CASE
TCK-14	14" Round	Each	12/48
TCK-16	16" Round	Each	12/36
TCK-14CK	Replacement Cork for CK-14	Each	50/350
TCK-16CK	Replacement Cork for CK-16	Each	50/350

**MULTI-CHANNEL GLASS HANGERS**

- ◆ Chrome-plated

ITEM	DESCRIPTION	SIZE	UOM	CASE
GHC-1836	8 Channels	18" x 36" x 4"	Each	2/4
GHC-1848	11 Channels	18" x 48" x 4"	Each	2/4

**OVERHEAD GLASS RACKS**

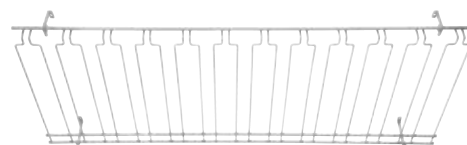

GHC-1848  
(11 CHANNELS)

**SINGLE-CHANNEL GLASS HANGERS**

ITEM	DESCRIPTION	SIZE	UOM	CASE
GH-10	Brass Plated	10"	Each	12/72
GH-16	Brass Plated	16"	Each	12/72
GH-24	Brass Plated	24"	Each	12/48
GHC-10	Chrome Plated	10"	Each	12/72
GHC-16	Chrome Plated	16"	Each	12/72
GHC-24	Chrome Plated	24"	Each	12/48



GH-16



GHC-16

**BAR LINERS**

- ◆ Roll measures 2'W x 40'L
- ◆ Available in assorted colors
- ◆ BPA-free

ITEM	DESCRIPTION	UOM	CASE
BL-240C	Clear	Roll	2
BL-240G	Green	Roll	2
BL-240K	Black	Roll	2
BL-240R	Red	Roll	2
BL-240W	White	Roll	2

**BAR LINERS & SERVICE MATS**



BL-SERIES **BPA FREE**

**BAR SERVICE MATS**

- ◆ Measures 12" x 18"
- ◆ NSF listed

ITEM	DESCRIPTION	UOM	CASE
BM-1812B	Brown	Each	12
BM-1812K	Black	Each	12

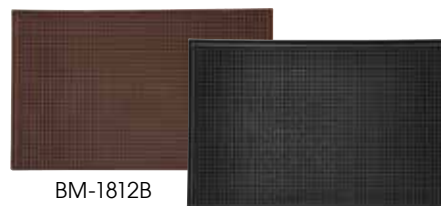

BM-1812B

BM-1812K

BM-SERIES **NSF**

**INTERLOCKING BAR MATS**

- ◆ Measures 12" x 12"
- ◆ Cuts easily to fit any counter shape
- ◆ Lightweight and dishwasher safe
- ◆ NSF listed

ITEM	DESCRIPTION	UOM	CASE
BML-12C	Clear	Each	12/24
BML-12K	Dark Smoke	Each	12/24

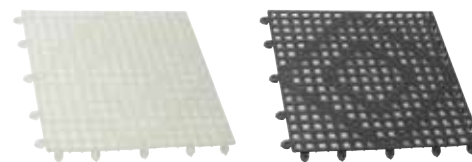

BML-12C

BML-12K

BML-SERIES **NSF**

**BAR RAIL SPILL MATS**

- ◆ Measures 3-1/4" x 27"
- ◆ NSF listed

ITEM	DESCRIPTION	UOM	CASE
BM-327B	Brown, NSF	Each	12/48
BM-327K	Black, NSF	Each	12/48



BM-327B **NSF**



BM-327K **NSF**

BAR CLEAN-UP



SAS-4



MAS-4K



MAS-4R



GWB-3



GWB-3-BR



GWB-1



ABSORBENT  
MICROFIBER

BRIGHTER  
COLORS

BTM-16AC



BTM-16W

ALL-WHITE  
MICROFIBER  
6-PACK



BTGP-21

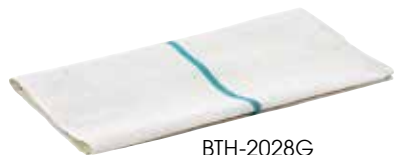

BTH-2028G



BTW-30



OP-7

STAINLESS STEEL ASHTRAY

ITEM	DESCRIPTION	UOM	CASE
SAS-4	4" Dia, Stackable	Each	24/96

PLASTIC ASHTRAYS

- ◆ Heat resistant up to 338°F (170°C)

ITEM	DESCRIPTION	UOM	CASE
MAS-4K	4" Dia, Black	Doz	12
MAS-4R	4" Dia, Red	Doz	12

GLASS WASHER BRUSHES

- ◆ Four (4) suction feet provide stability on slippery surfaces
- ◆ Dishwasher safe

ITEM	DESCRIPTION	UOM	CASE
GWB-3	3 Brushes with Base	Each	1/12
GWB-3-BR	Brush for GWB-3	Each	1/100

BEER MUG WASHER

*Eliminate hand-scrubbing glassware with Winco's Beer Mug Washer. The long-lasting nylon bristles are tough on grime, but won't scratch or damage glass. The four suction-feet hold firm to surfaces while in use.*

- ◆ Features one glass washer that stands in the center with additional scrubbing bristles inside the top rim
- ◆ Wide enough to accommodate a beer mug & the handle
- ◆ Dirty water can be drained through detachable hose
- ◆ Durable and space-saving

ITEM	DESCRIPTION	UOM	CASE
GWB-1	Manual Mug Washer	Each	1/6

MICROFIBER TOWELS

- ◆ Lightweight, super absorbent and quick drying
- ◆ Multi-color pack contains 1 of each color: yellow, blue, white, green, orange, red
- ◆ Dimensions: 16" x 16"
- ◆ Each pack has hanging hook and contains six (6) towels

ITEM	DESCRIPTION	UOM	CASE
BTM-16AC	Assorted Colors	Pack	1/20
BTM-16W	White	Pack	1/20

GLASS POLISHING TOWEL

- ◆ 100% cotton w/red pinstripes
- ◆ Lint-free and non-abrasive to eliminate streaking, yet is gentle on glassware
- ◆ Thousands of microscopic fibers pick up dirt and dust
- ◆ Absorbs seven times its weight in liquids, also ideal for countertops and tabletops

ITEM	DESCRIPTION	UOM	CASE
BTGP-21	16" x 29"	Doz	10/20

HERRINGBONE BAR TOWEL

- ◆ 100% cotton, super absorbent
- ◆ Green stripe provides easy designation of towel for specific use to prevent cross-contamination

ITEM	DESCRIPTION	UOM	CASE
BTH-2028G	20" x 28"	Doz	10/20

WHITE BAR TOWEL

- ◆ 100% cotton

ITEM	DESCRIPTION	UOM	CASE
BTW-30	16" x 19"	Doz	10/20

POLYPROPYLENE OVERFLOW PIPES

- ◆ Rubber head provides snug, secure fit

ITEM	DESCRIPTION	UOM	CASE
OP-7	7" L x 1" Dia	Each	24/288
OP-11	11" L x 1" Dia	Each	12/144



# KITCHEN

*Prep & Cook*



## THE SIGNATURE LOOK

Great Quality. Great Value.

Built tough to stand up to the demands of the commercial kitchen, **Signature Chef by Winco®** mixes all the right ingredients in chef apparel, fit for any budget.

### CHEF JACKETS



UNF-5WM

#### UNIVERSAL FIT CHEF JACKETS - WHITE

- ◆ Double breasted, with thermometer/pen pocket & chest pocket
- ◆ 65/35 poly-cotton blend
- ◆ Available in white

◆ Color display box only available with full case (FC) qty

Refer to size chart at back of catalog



ITEM	COLOR	SIZE	UOM	CASE	QTY/FC
UNF-5WS	White	S	Each	12/24	12
UNF-5WM	White	M	Each	12/24	12
UNF-5WL	White	L	Each	12/24	12
UNF-5WXL	White	XL	Each	12/24	12
UNF-5WXXL	White	2X	Each	12/24	12
UNF-5W3XL	White	3X	Each	12/24	12

Individually packaged in printed poly-bag



Color box with full case purchase

NEW COLOR

AVAILABLE IN AUGUST 2020



UNF-6RM

#### MEN'S TAPERED FIT CHEF JACKETS - RED, WHITE, BLACK

- ◆ Double breasted with thermometer/pen pocket
- ◆ 65/35 poly-cotton blend
- ◆ Available in red, white or black

◆ Color display box only available with full case (FC) qty

Refer to size chart at back of catalog



ITEM	COLOR	SIZE	UOM	CASE	QTY/FC
UNF-6RS	Red	S	Each	12/24	12
UNF-6RM	Red	M	Each	12/24	12
UNF-6RL	Red	L	Each	12/24	12
UNF-6RXL	Red	XL	Each	12/24	12
UNF-6WS	White	S	Each	12/24	12
UNF-6WM	White	M	Each	12/24	12
UNF-6WL	White	L	Each	12/24	12
UNF-6WXL	White	XL	Each	12/24	12
UNF-6WXXL	White	2X	Each	12/24	12
UNF-6W3XL	White	3X	Each	12/24	12
UNF-6W4XL	White	4X	Each	12/24	12
UNF-6KS	Black	S	Each	12/24	12
UNF-6KM	Black	M	Each	12/24	12
UNF-6KL	Black	L	Each	12/24	12
UNF-6KXL	Black	XL	Each	12/24	12
UNF-6KXXL	Black	2X	Each	12/24	12
UNF-6K3XL	Black	3X	Each	12/24	12
UNF-6K4XL	Black	4X	Each	12/24	12

Individually packaged in printed poly-bag



Color box with full case purchase



UNF-6WM



UNF-6KM

Replaces former UNF-5K series



# CHEF JACKETS



## MEN'S TAPERED FIT CHEF JACKETS - GRAY

- ◆ Double breasted with thermometer/pen pocket
- ◆ 65/35 poly-cotton blend
- ◆ Roll-tab sleeves with button
- ◆ Available in gray
- ◆ Color display box only available with full case (FC) qty

Refer to size chart at back of catalog



ITEM	COLOR	SIZE	UOM	CASE	QTY/FC
UNF-10GS	Black	S	Each	12/24	12
UNF-10GM	Black	M	Each	12/24	12
UNF-10GL	Black	L	Each	12/24	12
UNF-10GXL	Black	XL	Each	12/24	12
UNF-10GXXL	Black	2X	Each	12/24	12

Individually packaged in printed poly-bag



Color box with full case purchase



UNF-10GM



AVAILABLE IN AUGUST 2020



Pocket on sleeve

SEE PAGE 168 FOR MERCHANDISING DISPLAY

## WOMEN'S TAPERED FIT CHEF JACKETS - WHITE OR BLACK

- ◆ Double breasted with thermometer/pen pocket
- ◆ 65/35 poly-cotton blend
- ◆ Available in white or black
- ◆ Color display box only available with full case (FC) qty

Refer to size chart at back of catalog



ITEM	COLOR	SIZE	UOM	CASE	QTY/FC
UNF-7WS	White	S	Each	12/24	12
UNF-7WM	White	M	Each	12/24	12
UNF-7WL	White	L	Each	12/24	12
UNF-7KS	Black	S	Each	12/24	12
UNF-7KM	Black	M	Each	12/24	12
UNF-7KL	Black	L	Each	12/24	12

Individually packaged in printed poly-bag



Color box with full case purchase



UNF-7WM



UNF-7KM



## VENTILATED SHIRTS



### TAPERED FIT VENTILATED SHIRTS - WHITE OR BLACK

- ◆ Cool mesh panels on back, sides and underarms
- ◆ Wide chest pocket & double thermometer/pen pocket
- ◆ Lightweight 65/35 poly-cotton blend
- ◆ Available in white or black

◆ Color display box only available with full case (FC) qty

Refer to size chart at back of catalog

S M L XL 2X 3X

ITEM	COLOR	SIZE	UOM	CASE	QTY/FC
UNF-9WS	White	S	Each	18/36	18
UNF-9WM	White	M	Each	18/36	18
UNF-9WL	White	L	Each	18/36	18
UNF-9WXL	White	XL	Each	18/36	18
UNF-9WXXL	White	2X	Each	18/36	18
UNF-9W3XL	White	3X	Each	18/36	18
UNF-9KS	Black	S	Each	18/36	18
UNF-9KM	Black	M	Each	18/36	18
UNF-9KL	Black	L	Each	18/36	18
UNF-9KXL	Black	XL	Each	18/36	18
UNF-9KXXL	Black	2X	Each	18/36	18
UNF-9K3XL	Black	3X	Each	18/36	18

Individually packaged in printed poly-bag



Color box with full case purchase

AVAILABLE IN AUGUST 2020

NEW SIZE



UNF-9WM

COOL MESH

Ventilated back, sides and underarms

AVAILABLE IN AUGUST 2020

NEW SIZE



UNF-9KM

COOL MESH

Ventilated back, sides and underarms



Cool mesh



SEE PAGE 168 FOR MERCHANDISING DISPLAY

## SNAP-BUTTON SHIRTS



### SNAP-BUTTON SHIRTS - WHITE OR BLACK

- ◆ Short-sleeved chef shirts feature a chest pocket and snap-button fasteners
- ◆ Lightweight 65/35 poly-cotton blend
- ◆ Available in white or black

◆ Color display box only available with full case (FC) qty

Refer to size chart at back of catalog

S M L XL 2X 3X 4X

ITEM	COLOR	SIZE	UOM	CASE	QTY/FC
UNF-1WS	White	S	Each	24/48	24
UNF-1WM	White	M	Each	24/48	24
UNF-1WL	White	L	Each	24/48	24
UNF-1WXL	White	XL	Each	24/48	24
UNF-1WXXL	White	2X	Each	24/48	24
UNF-1W3XL	White	3X	Each	24/48	24
UNF-1W4XL	White	4X	Each	24/48	24
UNF-1KS	Black	S	Each	24/48	24
UNF-1KM	Black	M	Each	24/48	24
UNF-1KL	Black	L	Each	24/48	24
UNF-1KXL	Black	XL	Each	24/48	24
UNF-1KXXL	Black	2X	Each	24/48	24
UNF-1K3XL	Black	3X	Each	24/48	24
UNF-1K4XL	Black	4X	Each	24/48	24

Individually packaged in printed poly-bag



Color box with full case purchase



UNF-1WM



UNF-1KM

### **WOMEN'S CHEF PANTS - BLACK**

- ◆ Solid black, straight-leg
- ◆ Elastic drawstring waist
- ◆ Two front pockets
- ◆ 65/35 poly-cotton blend
- ◆ Color display box only available with full case (FC) qty

Refer to size chart at back of catalog

ITEM	COLOR	SIZE	UOM	CASE	QTY/FC
UNF-8KS	Black	S	Each	12/24	12
UNF-8KM	Black	M	Each	12/24	12
UNF-8KL	Black	L	Each	12/24	12



### **CARGO CHEF PANTS - BLACK**

- ◆ Solid black, straight-leg
- ◆ Elastic drawstring waist
- ◆ Cargo pockets with velcro closure
- ◆ 65/35 poly-cotton blend
- ◆ Color display box only available with full case (FC) qty

Refer to size chart at back of catalog

ITEM	COLOR	SIZE	UOM	CASE	QTY/FC
UNF-11KXS	Black	XS	Each	12/24	12
UNF-11KS	Black	S	Each	12/24	12
UNF-11KM	Black	M	Each	12/24	12
UNF-11KL	Black	L	Each	12/24	12
UNF-11KXL	Black	XL	Each	12/24	12
UNF-11KXXL	Black	2X	Each	12/24	12

### **CHEF PANTS - BLACK**

- ◆ Relaxed, universal fit; elastic drawstring waist
- ◆ Two side-seam pockets
- ◆ 65/35 poly-cotton blend
- ◆ Color display box only available with full case (FC) qty

Refer to size chart at back of catalog

ITEM	COLOR	SIZE	UOM	CASE	QTY/FC
UNF-2KS	Black	S	Each	12/24	12
UNF-2KM	Black	M	Each	12/24	12
UNF-2KL	Black	L	Each	12/24	12
UNF-2KXL	Black	XL	Each	12/24	12
UNF-2KXXL	Black	2X	Each	12/24	12

## BLACK PANTS



## UNIVERSAL FIT PANTS



UNF-3CM



Individually packaged in printed poly-bag



Woven pattern



Elastic drawstring waist

### CHEF PANTS - WOVEN CHALKSTRIPE

- ◆ Relaxed, universal fit; elastic drawstring waist
- ◆ Two side-seam pockets
- ◆ 65/35 poly-cotton blend
- ◆ Color display box only available with full case (FC) qty

Refer to size chart at back of catalog



ITEM	COLOR	SIZE	UOM	CASE	QTY/FC
UNF-3CS	Chalkstripe	S	Each	12/24	12
UNF-3CM	Chalkstripe	M	Each	12/24	12
UNF-3CL	Chalkstripe	L	Each	12/24	12
UNF-3CXL	Chalkstripe	XL	Each	12/24	12
UNF-3CXXL	Chalkstripe	2X	Each	12/24	12



UNF-4KM



Individually packaged in printed poly-bag

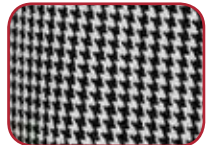

Pattern



Elastic waistband, inner drawstring

### CHEF PANTS - HOUNDSTOOTH

- ◆ Relaxed, universal fit; elastic waistband with inner drawstring
- ◆ Two side-seam pockets
- ◆ 65/35 poly-cotton blend
- ◆ Color display box only available with full case (FC) qty

Refer to size chart at back of catalog



ITEM	COLOR	SIZE	UOM	CASE	QTY/FC
UNF-4KS	Houndstooth	S	Each	12/24	12
UNF-4KM	Houndstooth	M	Each	12/24	12
UNF-4KL	Houndstooth	L	Each	12/24	12
UNF-4KXL	Houndstooth	XL	Each	12/24	12
UNF-4KXXL	Houndstooth	2X	Each	12/24	12

## BIB APRONS



### WOVEN CHALKSTRIPE BIB APRON

The stripe pattern of this bib apron is woven in, making for a lasting appearance that stands up to busy service and bartending shifts.

- ◆ 65/35 poly-cotton blend
- ◆ Two (2) waist pockets; designed to hold digital tablets up to 8" wide
- ◆ 33-1/2"L x 27"W



BA-3427CS



Model: 6'



Woven pattern

ITEM	DESCRIPTION	UOM	CASE
BA-3427CS	Chalkstripe w/Pockets	Each	12/60

INDIVIDUALLY PACKAGED IN PRINTED POLY-BAG

## BIB APRONS



SEE PAGE 168 FOR MERCHANDISING DISPLAY

### HEAVYWEIGHT DENIM BIB APRON, CROSS-BACK

The durable cross-back denim bib apron is a stylish choice for front of house. The dark wash masks spills and stains while keeping up appearances.

- ◆ 80/20 cotton-poly blend
- ◆ Heavyweight dark wash denim
- ◆ Contrast stitching, brass rivets
- ◆ Cross-back straps
- ◆ Metal rings to secure ties
- ◆ Two (2) slanted waist pockets
- ◆ Thermometer/pen pocket
- ◆ 31-3/4"L x 26-3/4"W



◆ Color display box only available with full case (FC) qty

ITEM	COLOR	UOM	CASE
BADN-3126	Dark Wash w/Brown Straps	Each	12/24



### HEAVYWEIGHT DENIM BIB APRON, ADJUSTABLE NECK

Outfit front of house staff with this hard-wearing dark wash denim apron. Adjust the neck strap to achieve the perfect length.

- ◆ 80/20 cotton-poly blend
- ◆ Heavyweight dark wash denim
- ◆ Contrast stitching
- ◆ Adjustable buckle neck strap
- ◆ Two (2) vertical waist pockets
- ◆ Open chest pocket
- ◆ Zippered cell-phone pocket
- ◆ 34-1/2"L x 30-1/4"W



◆ Color display box only available with full case (FC) qty

ITEM	COLOR	UOM	CASE
BADN-3430	Dark Wash w/Gray Straps	Each	12/24



### MID-WEIGHT BIB APRONS

These mid-weight bib aprons are the perfect addition to uniforms calling for a streamlined look. Features include an adjustable neck strap, a thermometer pocket, and eight (8) different size waist pockets.

- ◆ Blue apron is 65/35 poly-cotton blend
- ◆ Black apron is 80/20 poly-cotton blend
- ◆ Adjustable snap-button neck strap
- ◆ Thermometer/pen pocket
- ◆ Eight (8) waist pockets
- ◆ 33-1/2"L x 27"W

◆ Color display box only available with full case (FC) qty

ITEM	COLOR	UOM	CASE
BA-3327B	Blue	Each	24/48
BA-3327K	Black	Each	24/48



## BIB APRONS



### 3-POCKET MID-LENGTH BIB APRONS

- ◆ 65/35 poly-cotton blend
- ◆ Adjustable buckle neck strap
- ◆ Three (3) vertical waist pockets
- ◆ 24"L x 27-1/2"W

ITEM	COLOR	UOM	CASE
BA-2724W	White	Each	12/60
BA-2724K	Black	Each	12/60

INDIVIDUALLY  
PACKAGED IN  
PRINTED POLY-BAG



BA-2724K

Model: 5' 3"



BA-2724W



BA-PBL

Model: 6'



### FULL-LENGTH BIB APRONS, ASSORTED COLORS

- ◆ Pen and pad pockets on select items
- ◆ 65/35 poly-cotton blend, machine wash and dry; wrinkle-resistant
- ◆ Assorted colors available
- ◆ 33"L x 26"W

ITEM	DESCRIPTION	UOM	CASE
BA-3226WH	White, No Pockets	Each	12/60
BA-3226BK	Black, No Pockets	Each	12/60
BA-PBG	Burgundy, w/Pockets	Each	12/60
BA-PBK	Black, w/Pockets	Each	12/60
BA-PBL	Blue, w/Pockets	Each	12/60
BA-PGN	Green, w/Pockets	Each	12/60
BA-PLG	Light Green, w/Pockets	Each	12/60
BA-PRD	Red, w/Pockets	Each	12/60
BA-PWH	White, w/Pockets	Each	12/60

INDIVIDUALLY  
PACKAGED IN  
PRINTED POLY-BAG



BA-SERIES, WITHOUT POCKETS



Available Colors

BA-SERIES, WITH PEN & PAD POCKETS

## WHITE COTTON SERVICE GLOVES



### WHITE COTTON SERVICE GLOVES

ITEM	DESCRIPTION	UOM	CASE
GLC-M	Medium (6 pairs)	Doz	100
GLC-L	Large (6 pairs)	Doz	100

GLC-M





### BISTRO FULL LENGTH APRONS

These full length bistro/waist aprons are a versatile addition to staff uniforms, going from casual to formal, all with a polished look.

- ◆ 65/35 poly-cotton blend
- ◆ Two (2) large utility pockets; fits most digital tablets

ITEM	DESCRIPTION	UOM	CASE
WA-3129WH	White	Each	12/60
WA-3129BK	Black	Each	12/60

INDIVIDUALLY PACKAGED IN PRINTED POLY-BAG



Models (L to R): 6' / 5' 3" / 5' 7"

### SERVICE APRONS



WA-3129WH

WA-3129BK



### BISTRO HALF LENGTH APRONS

Simple and crisp, the half length bistro aprons are adaptable across a multitude of settings.

- ◆ 65/35 poly-cotton blend
- ◆ Two (2) utility pockets; fits most digital tablets
- ◆ 19"L x 28"W

ITEM	DESCRIPTION	UOM	CASE
WA-2819W	White	Each	12/60
WA-2819K	Black	Each	12/60

INDIVIDUALLY PACKAGED IN PRINTED POLY-BAG



WA-2819W

WA-2819K



### FOUR-WAY APRONS

These aprons offer four (4) surfaces for a quick-flip change to present a clean side on the fly, without the need for switching to a new apron.

- ◆ 65/35 poly-cotton blend
- ◆ 17"L x 34"W

ITEM	DESCRIPTION	UOM	CASE
WA4-3417W	White	Each	12/60
WA4-3417K	Black	Each	12/60

INDIVIDUALLY PACKAGED IN PRINTED POLY-BAG

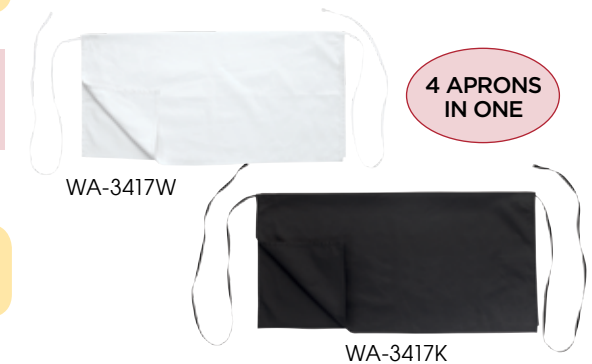

WA-3417W

WA-3417K



### 3-POCKET WAIST APRONS

- ◆ Cotton-poly blend, machine wash and dry, wrinkle resistant
- ◆ Available in four (4) colors
- ◆ 12-1/2"L x 21-3/4"W

ITEM	DESCRIPTION	UOM	CASE
WA-1221	Black	Each	12/60
WA-1221G	Green	Each	12/60
WA-1221R	Burgundy	Each	12/60
WA-1221RED	Red	Each	12/60
WA-1221W	White	Each	12/60

INDIVIDUALLY PACKAGED IN PRINTED POLY-BAG



WA-1221RED



WA-1221

WA-1221G

WA-1221R

WA-1221W



## DISHWASHING APRONS



BAW-2540BK



BAW-2740BN



Faux leather texture



### DISHWASHING APRONS

The easy on-and-off, full-length dishwashing aprons repel spills and splashes, keeping uniforms dry and presentable throughout a shift.

- ◆ Water resistant
- ◆ Black apron is lightweight nylon/PVC/polyester blend
- ◆ Brown apron is heavyweight vinyl with faux leather front

ITEM	DESCRIPTION	SIZE	UOM	CASE
BAW-2540BK	Black, Lightweight	40"L x 25-1/2"W	Each	12/60
BAW-2740BN	Brown, Heavyweight	40"H x 27-1/2"W	Each	12/60

INDIVIDUALLY PACKAGED IN PRINTED POLY-BAG

## HEAVY VINYL APRONS



BA-HN



BA-LA



### HEAVY VINYL BLACK APRONS

ITEM	DESCRIPTION	SIZE	UOM	CASE
BA-HN	Heavy Vinyl w/Pocket	41-1/4"L x 26-1/2"W	Each	12/24
BA-LA	Latex	44-1/2"L x 37"W	Each	12

INDIVIDUALLY PACKAGED IN PRINTED POLY-BAG

## DISPOSABLE CHEF HATS



DCH-12



DCH-9



DCH-3

### DISPOSABLE CHEF HATS

- ◆ White paper
- ◆ Three height options
- ◆ Wide head band

ITEM	DESCRIPTION	SIZE	UOM	CASE
DCH-3	3" H	100 pcs/Box	Box	1/10
DCH-9	9" H	10 pcs/Bag	Bag	1/20
DCH-12	12" H	10 pcs/Bag	Bag	1/20



### VENTILATED PILLBOX HATS

The lightweight pillbox hat features straight sides with no brim for a clean, professional look. The ventilated mesh top is designed to help keep a cool head, and the elastic band on the back allows for a snug, secure fit.

- ◆ 65/35 poly-cotton blend
- ◆ Cool mesh top panel
- ◆ Available in regular and extra-large sizes
- ◆ Color display box only available with full case (FC) qty

ITEM	DESCRIPTION	UOM	CASE	QTY/FC
◆ CHPB-3RR	3.5"H, Red, Regular	Each	48/96	48
◆ CHPB-3RX	3.5"H, Red, X-Large	Each	48/96	48
◆ CHPB-3WR	3.5"H, White, Regular	Each	48/96	48
◆ CHPB-3BR	3.5"H, Black, Regular	Each	48/96	48
◆ CHPB-3WX	3.5"H, White, X-Large	Each	48/96	48
◆ CHPB-3BX	3.5"H, Black, X-Large	Each	48/96	48

### CHEF HATS

**NEW COLOR** AVAILABLE IN JULY 2020



CHPB-3RR



CHPB-3WR



CHPB-3BR

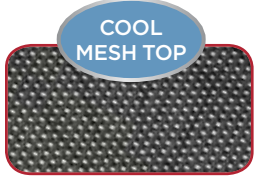

Cool mesh



All stylers feature an elastic back

### HEAD WRAP

- ◆ 65/35 poly-cotton blend
- ◆ Lightweight, breathable comfort
- ◆ Ties at back adjust for best fit
- ◆ One size fits most
- ◆ Color display box only available with full case (FC) qty

ITEM	DESCRIPTION	UOM	CASE	QTY/FC
◆ CHHW-3K	Black	Each	48/96	48



CHHW-3K



Adjust ties at back for best fit

### BASEBALL CAP

- ◆ 65/35 poly-cotton blend
- ◆ Adjustable metal buckle for best fit
- ◆ Sturdy visor
- ◆ Eyelet ventilation on top
- ◆ Built-in sweatband helps to wick away moisture
- ◆ Color display box only available with full case (FC) qty

ITEM	DESCRIPTION	UOM	CASE	QTY/FC
◆ CHBC-4BK	Black	Each	36/72	36



CHBC-4BK



Adjustable buckle

### FABRIC PROFESSIONAL CHEF HATS

- ◆ 65/35 poly-cotton blend
- ◆ Wrinkle resistant in assortment of colors
- ◆ Adjustable velcro closure from 21" to 24"
- ◆ Wide head band; 13" high overall

ITEM	DESCRIPTION	UOM	CASE
◆ CH-13BG	Burgundy	Each	24/96
◆ CH-13BK	Black	Each	24/96
◆ CH-13BL	Blue	Each	24/96
◆ CH-13GN	Green	Each	24/96
◆ CH-13LG	Light Green	Each	24/96
◆ CH-13RD	Red	Each	24/96
◆ CH-13WH	White	Each	24/96

INDIVIDUALLY PACKAGED IN PRINTED POLY-BAG



Adjustable velcro closure



CH-13BK



CH-13WH



Burgundy Blue Green Light Green Red

# THE SIGNATURE LOOK MERCHANDISING DISPLAY

*Holds 24 Cases*

**FREE**  
**SIGNATURE CHEF**  
**DISPLAY**

available with  
qualifying  
order

*1 display per location*

Items individually  
packaged in printed  
clear bag

Resealable  
zipper closure



Color Box is available  
with each FC/full case  
purchase per item.

Available with select  
items as noted.





"We only put our signature on something we *Truly believe in...* something that has **QUALITY** and a **HIGH STANDARD.**"



*The only cutlery endorsed by American Master Chefs' Order*

## ACERO FORGED CUTLERY



The Acero cutlery collection is crafted from forged German steel. Each knife is ice tempered for ultra-sharpness and edge retention, providing professional results that won't break the bank.

Acero is the only cutlery brand endorsed by the prestigious American Master Chefs' Order, a non-profit organization comprised of an elite chef group.

- ◆ Forged, ice tempered stainless steel holds a sharp edge
- ◆ Full-tang construction for precise control
- ◆ Crafted of X50 Cr Mo V15 German steel for ultimate durability
- ◆ POM injection-molded handle for balanced weight distribution
- ◆ 6-spot advanced polishing allows for comfortable grip
- ◆ NSF listed

ITEM	DESCRIPTION	BLADE	UOM	CASE
KFP-30	Peeling Knife	2-3/4" L	Each	6/72
KFP-35	Paring Knife	3-1/2" L	Each	6/72
KFP-50	Utility Knife	5" L	Each	6/72
KFP-51	Tomato Knife	5" L	Each	6/72
KFP-61	Boning Knife	6" L	Each	6/36
KFP-70	Santoku Knife	7" L	Each	6/36
KFP-73	Nakiri Knife	7" L	Each	6/36



The only cutlery endorsed by American Master Chefs' Order

#aceofblades



KFP-SERIES



KFP-30

AMCO must-have



KFP-35



KFP-50



KFP-51



KFP-61

AMCO must-have



KFP-70



KFP-73



- X50 CR MO V15 German Steel
- Fully Forged - Full Tang
- Ice Tempered Blade
- Unique POM Handle



SEE PAGE 196 FOR DISPLAY RACKS

# ACERO FORGED CUTLERY

## CHEF'S KNIVES

◆ NSF listed

ITEM	DESCRIPTION	BLADE	UOM	CASE
KFP-60	Chef's Knife	6" L	Each	6/36
KFP-80	Chef's Knife	8" L	Each	6/36
KFP-84	Chef's Knife, Hollow Ground	8" L	Each	6/36
KFP-85	Chef's Knife, Short Bolster	8" L	Each	6/36
KFP-100	Chef's Knife	10" L	Each	6/36
KFP-103	Chef's Knife, Hollow Ground	10" L	Each	6/36
KFP-104	Chef's Knife Short Bolster	10" L	Each	6/36
KFP-120	Chef's Knife	12" L	Each	6/36



The only cutlery endorsed by American Master Chefs' Order

#aceofblades



KFP-SERIES



KFP-60



KFP-80



KFP-84



KFP-85



KFP-100



KFP-103



KFP-104



KFP-120

FULLY FORGED BLADE



**ACERO FORGED CUTLERY**

◆ NSF listed

ITEM	DESCRIPTION	BLADE	UOM	CASE
KFP-74	Fillet Knife, Flexible	7" L	Each	6/36
KFP-83	Bread Knife, Offset	8" L	Each	6/36
KFP-82	Bread Knife	8" L	Each	6/36
KFP-81	Slicer	8" L	Each	6/36
KFP-101	Slicer, Granton Edge	10" L	Each	6/36
KFP-102	Fish/Roast Slicer, Granton Edge	10" L	Each	6/36

**ACERO FORGED CUTLERY**



The only cutlery endorsed by American Master Chefs' Order

**NSF** KFP-SERIES



KFP-74



KFP-83



KFP-82



KFP-81



KFP-101



KFP-102

**ACERO FORGED COOK'S FORKS**

◆ Extra heavyweight  
◆ NSF listed

ITEM	DESCRIPTION	PRONGS	UOM	CASE
KFP-71	Straight, 12" w/Hdl	6"L	Each	6/36
KFP-62	Curved, 12" w/Hdl	6"L	Each	6/36
KFP-121	Curved, 12" w/Hdl	4"L	Each	6/36
KFP-140	Curved, 14" w/Hdl	5"L	Each	6/36
KFP-180	Curved, 18" w/Hdl	5"L	Each	6/36

#aceofblades

**NSF** KFP-SERIES



KFP-71



KFP-62



KFP-121



KFP-140



KFP-180

### ACERO KNIFE BLOCK SET

Designed to outfit any kitchen, the 7-piece forged knife block set is stocked with essential cutlery for all food prep tasks. The space-saving knife block is comprised of top-of-the-line tools, including bonus kitchen shears. Storing knives in a block is a convenient way to preserve the knives' sharp edges.

◆ Knives included are NSF listed

ITEM	DESCRIPTION	UOM	CASE
KFP-BLKA	7-Pc Knife Block Set	Set	1/4

**Includes:**

- ◆ 3.5" Paring Knife (KFP-35)
- ◆ 5" Utility Knife (KFP-50)
- ◆ 6" Boning Knife (KFP-61)
- ◆ 8" Chef Knife (KFP-80)
- ◆ 8" Bread Knife (KFP-82)
- ◆ 8" Sharpening Steel
- ◆ Wooden Knife Block
- ◆ Bonus Shears (KS-06)



KFP-BLKA KNIVES NSF

### ACERO FORGED CUTLERY



The only cutlery endorsed by American Master Chefs' Order

### ACERO KNIFE KIT

This 8-piece kit features must-have chef essentials, including a carry case for convenient storage and easy transport from kitchen to kitchen.

◆ Knives included are NSF listed

ITEM	DESCRIPTION	UOM	CASE
KFP-KITA	7-Pc Knife Kit	Set	1/6

**Includes:**

- ◆ 3.5" Paring Knife (KFP-35)
- ◆ 6" Boning Knife (KFP-61)
- ◆ 8" Chef Knife (KFP-80)
- ◆ 8" Bread Knife (KFP-82)
- ◆ 10" Slicer (KFP-101)
- ◆ 12" Sharpening Steel (KFP-122)
- ◆ 11-slot Knife Bag (KBG-11)
- ◆ Bonus Shears (KS-06)



#aceofblades

### AMCO must-have



KFP-KITA KNIVES NSF

### ACERO DIAMOND STEEL SHARPENERS

Durable and long lasting, these diamond coated steel rods sharpen knives faster than conventional stones. The extra-fine grit allows for regular honing or final polishing.

◆ NSF listed

ITEM	DESCRIPTION	LENGTH	UOM	CASE
KFP-122	20mm Width, Oval	12"	Each	6/24
KFP-123	12mm Dia, Round	12"	Each	6/24



KFP-122



Shape of KFP-122



KFP-123

KFP-SHARPENERS NSF

## SOF-TEK™ SOFT GRIP CUTLERY



The SOF-TEK™ series is durable and built for the demands of busy, commercial kitchens. The specially designed slip-resistant, soft-grip handle allows exceptional control, while the sharp edge provides maximum cutting performance.

- ◆ Razor-sharp X50 Cr Mo V15 German steel blade
- ◆ The comfortable soft-touch, non-slip handle helps to reduce arm and hand fatigue
- ◆ Easy edge maintenance and rapid sharpening
- ◆ NSF listed

ITEM	DESCRIPTION	BLADE	UOM	CASE
KSTK-30	Paring Knife, 2-Pcs/Pk	3-1/4" L	Pack	6/36
KSTK-31	Serrated Paring Knife, 2-Pcs/Pk	3-1/2" L	Pack	6/36
KSTK-50	Utility Knife, Serrated Edge	5-1/2" L	Each	6/36
KSTK-60	Boning Knife, Curved	6" L	Each	6/36
KSTK-61	Boning Knife, Narrow	6" L	Each	6/36
KSTK-62	Boning Knife, Wide	6" L	Each	6/36
KSTK-82	Fillet Knife, Flexible	8" L	Each	6/36
KSTK-92	Bread/Utility Knife, Offset	9" L	Each	6/36
KSTK-91	Bread Knife, Curved, Wavy Edge	9-1/2" L	Each	6/36
KSTK-102	Bread/Pastry Knife, Wide	10" L	Each	6/36



2PCS PER PACK



KSTK-30



KSTK-31



KSTK-50



KSTK-60



KSTK-61



KSTK-62



KSTK-82



KSTK-92



KSTK-91



KSTK-102

• X50 CR MO V15 German Steel  
• High Carbon  
• Razor sharp blade



NON-SLIP PINCH GRIP FOR ADDED SAFETY

SEE PAGE 196 FOR DISPLAY RACKS



NSF KSTK-SERIES

New Item





**SOF-TEK™ CHEF'S KNIVES**

◆ NSF listed

ITEM	DESCRIPTION	BLADE	UOM	CASE
KSTK-70	Santoku	7" L	Each	6/36
KSTK-80	Chef's Knife, Wide	8" L	Each	6/36
KSTK-100	Chef's Knife, Wide	10" L	Each	6/36

**SOF-TEK™ SOFT GRIP CUTLERY**



KSTK-70

KSTK-80

KSTK-100

KSTK-SERIES **NSF**

**SOF-TEK™ SOFT GRIP CUTLERY**

◆ NSF listed

ITEM	DESCRIPTION	BLADE	UOM	CASE
KSTK-103	Cimeter, Hollow Ground	10" L	Each	6/36
KSTK-121	Slicer, Wavy Edge	12" L	Each	6/36
KSTK-122	Slicer	12" L	Each	6/36
KSTK-140	Slicer, Hollow Ground, Wide	14" L	Each	6/36



KSTK-103

KSTK-121

KSTK-122

KSTK-140

KSTK-SERIES **NSF**

# STÄL STAMPED CUTLERY



Stäl series, our most economically priced line, offers the same level of quality and performance as others costing twice as much.

- ◆ Razor-sharp X50 Cr Mo V15 German steel blade
- ◆ Ergonomically designed, slip-resistant white polypropylene handles offer exceptional comfort, helping to reduce arm and hand fatigue
- ◆ Protective finger guard
- ◆ Easy edge maintenance and rapid sharpening
- ◆ NSF listed

ITEM	DESCRIPTION	BLADE	UOM	CASE
KWP-30	Paring Knife, 2-Pcs/Pk	3-1/4" L	Pack	6/36
KWP-31	Serrated Paring Knife, 2-Pcs/Pk	3-1/2" L	Pack	6/36
KWP-50	Utility Knife, Wavy Edge	5-1/2" L	Each	6/36
KWP-63	Utility Knife, Wavy Edge	6" L	Each	6/36
KWP-60	Boning Knife, Curved	6" L	Each	6/36
KWP-61	Boning Knife, Narrow	6" L	Each	6/36
KWP-62	Boning Knife, Wide	6" L	Each	6/36
KWP-92	Offset Utility/Bread Knife	9" L	Each	6/36
KWP-91	Bread Knife	9-1/2" L	Each	6/36

2PCS PER PACK



KWP-30



KWP-31



KWP-50



KWP-63



KWP-60



KWP-61



KWP-62



KWP-92



KWP-91



- X50 CR MO V15 German Steel
- High Carbon
- Stain Resistant



SEE PAGE 196 FOR DISPLAY RACKS



NSF KWP-SERIES

New Item



**STÄL CHEF'S KNIVES**

◆ NSF listed

ITEM	DESCRIPTION	BLADE	UOM	CASE
KWP-70	Santoku	7" L	Each	6/36
KWP-80	Chef's Knife	8" L	Each	6/36
KWP-81	Hollow Ground	8" L	Each	6/36
KWP-100	Chef's Knife	10" L	Each	6/36
KWP-101	Hollow Ground	10" L	Each	6/36

**STÄL STAMPED CUTLERY**



KWP-70



KWP-80



KWP-81



KWP-100



KWP-101

KWP-SERIES

**STÄL STAMPED CUTLERY**

◆ NSF listed

ITEM	DESCRIPTION	BLADE	UOM	CASE
KWP-82	Breaking Knife	8" L	Each	6/36
KWP-90	Cimeter Steak Knife	9-1/2" L	Each	6/36
KWP-93	Hollow Ground Cimeter	9-1/2" L	Each	6/36



KWP-82



KWP-90



KWP-93

KWP-SERIES



STÄL STAMPED CUTLERY



NEW



KWP-102

NEW



KWP-124

NSF KWP-SERIES

STÄL BUTCHER KNIVES

◆ NSF listed

ITEM	DESCRIPTION	BLADE	UOM	CASE
KWP-102	Butcher Knife	10" L	Each	6/36
KWP-124	Butcher Knife	12" L	Each	6/36

STÄL SLICERS

◆ NSF listed

ITEM	DESCRIPTION	BLADE	UOM	CASE
KWP-121	Slicer, Wavy Edge	12" L	Each	6/36
KWP-122	Roast Beef Slicer	12" L	Each	6/36
KWP-123	Hollow Ground Slicer	12" L	Each	6/36



KWP-121



KWP-122



KWP-123

NSF KWP-SERIES

STÄL PARING KNIFE BULK PACK



Includes 7 handle colors

NSF KWP-3046

STÄL PARING KNIFE BULK PACK

The ultra-useful paring knife now comes in bulk, packed in a convenient display bucket, perfect for impulse purchases! Available in an assortment of seven different colored handles.

- ◆ 3-1/4" paring knife made of X50 Cr Mo V15 German Steel
- ◆ Ergonomic, slip-resistant polypropylene handle is comfortable and helps to reduce hand fatigue
- ◆ Protective finger guard
- ◆ NSF listed

ITEM	DESCRIPTION	UOM	CASE
KWP-3046	46-Pc/Pk	Pack	1/4

**STÄL KNIFE KIT**

Carry and store knives in style with the convenient and travel-friendly knife roll-up storage bag. Includes 6 razor sharp, German steel stamped knives, a sharpening steel and bonus nylon spoon.

- ◆ Knives are NSF listed

ITEM	DESCRIPTION	UOM	CASE
KWP-KIT1	7-Pc Knife Kit	Set	1/6

**Includes:**

- ◆ 3.25" Paring Knife (KWP-30)
- ◆ 5.5" Utility Knife (KWP-50)
- ◆ 6" Boning Knife, Flexible (KWP-60)
- ◆ 9.5" Offset Bread/Utility Knife (KWP-91)
- ◆ 10" Hollow Ground Chef Knife (KWP-101)
- ◆ 12" Wavy Edge Slicer (KWP-121)
- ◆ 12" Sharpening Steel (K-12S)
- ◆ 11-slot Knife Bag (KBG-11)
- ◆ Bonus Red Nylon Spoon (NS-12R)



**STÄL KNIFE KIT**



KWP-KIT1 KNIVES **NSF**

**WINCO® SPREADER BULK PACK**

Practical for many uses around the kitchen, the spreader is now available in bulk. Packed in a convenient display bucket for impulse purchase positioning.

- ◆ Assortment of seven (7) colors included in convenient display bucket
- ◆ 3-5/8" spreader with stainless steel, satin finish blade
- ◆ Slip-free comfort grip
- ◆ NSF listed

ITEM	DESCRIPTION	UOM	CASE
TWP-3135	35-Pc/Pk	Pack	1/4

**WINCO® SPREADER BULK PACK**



Includes 7 handle colors

TWP-3135 **NSF**



NSF KWP-COLOR SERIES

X50 CR MO V15  
GERMAN STEEL  
HIGH CARBON  
STAIN RESISTANT

SEE PAGE 293  
FOR COLOR-CODED  
CUTTING BOARDS

## STÄL COLORED HANDLES



A selection of Stäl knives now come with HAACP color-coded non-slip handles for preventing cross-contamination and a variety of other uses around the kitchen.

- ◆ Razor-sharp X50 Cr Mo V15 German steel blade
- ◆ Ergonomically designed, slip-resistant polypropylene handles offer exceptional comfort, and help to reduce arm and hand fatigue
- ◆ Protective finger guard
- ◆ Easy edge maintenance and rapid sharpening
- ◆ NSF listed

HAACP STANDARD COLOR-CODING SYSTEM		
Raw Meats	Raw Poultry	Vegetable & Fruit
Bakery & Dairy	Cooked Meats	Seafood

2PCS PER  
PACK



KWP-30R



### 3-1/4" PARING KNIFE

ITEM	DESCRIPTION	UOM	CASE
KWP-30R	Red, 2-Pcs/Pk	Pack	6/36
KWP-30Y	Yellow, 2-Pcs/Pk	Pack	6/36
KWP-30G	Green, 2-Pcs/Pk	Pack	6/36
KWP-30N	Brown, 2-Pcs/Pk	Pack	6/36
KWP-30U	Blue, 2-Pcs/Pk	Pack	6/36



KWP-60R



### 6" BONING KNIFE

ITEM	DESCRIPTION	UOM	CASE
KWP-60R	Red	Each	6/36
KWP-60Y	Yellow	Each	6/36
KWP-60G	Green	Each	6/36
KWP-60N	Brown	Each	6/36
KWP-60U	Blue	Each	6/36



KWP-61R



### 6" NARROW BONING KNIFE

ITEM	DESCRIPTION	UOM	CASE
KWP-61R	Red	Each	6/36
KWP-61Y	Yellow	Each	6/36
KWP-61G	Green	Each	6/36
KWP-61N	Brown	Each	6/36
KWP-61U	Blue	Each	6/36

## STÅL COLORED HANDLES

### 7" SANTOKU KNIFE

ITEM	DESCRIPTION	UOM	CASE
KWP-70R	Red	Each	6/36
KWP-70Y	Yellow	Each	6/36
KWP-70G	Green	Each	6/36
KWP-70N	Brown	Each	6/36
KWP-70U	Blue	Each	6/36



KWP-70R



### 8" CHEF'S KNIFE

ITEM	DESCRIPTION	UOM	CASE
KWP-80R	Red	Each	6/36
KWP-80Y	Yellow	Each	6/36
KWP-80G	Green	Each	6/36
KWP-80N	Brown	Each	6/36
KWP-80U	Blue	Each	6/36



KWP-80R



### 9" OFFSET BREAD KNIFE

ITEM	DESCRIPTION	UOM	CASE
KWP-92R	Red	Each	6/36
KWP-92Y	Yellow	Each	6/36
KWP-92G	Green	Each	6/36
KWP-92N	Brown	Each	6/36
KWP-92U	Blue	Each	6/36



KWP-92R



### 10" CHEF'S KNIFE

ITEM	DESCRIPTION	UOM	CASE
KWP-100R	Red	Each	6/36
KWP-100Y	Yellow	Each	6/36
KWP-100G	Green	Each	6/36
KWP-100N	Brown	Each	6/36
KWP-100U	Blue	Each	6/36



KWP-100R



### 12" WAVY EDGE SLICER KNIFE

ITEM	DESCRIPTION	UOM	CASE
KWP-121R	Red	Each	6/36
KWP-121Y	Yellow	Each	6/36
KWP-121G	Green	Each	6/36
KWP-121N	Brown	Each	6/36
KWP-121U	Blue	Each	6/36



KWP-121R



KWP-COLOR SERIES 

# BLADE STATION™

## HANDS-FREE KNIFE SHARPENER



## GET YOUR EDGE.

Blade Station™  
keeps the  
line moving



### TIME SAVING

Has knives as  
sharp as NEW  
in just **4 swipes**



### SAFE & SECURE

**Hands-Free!**  
Reduce liability by  
keeping employees  
safe from cuts



### MOVABLE

Easily  
transport to  
any worktop



### EASY TO CLEAN

Dishwasher safe



### DIAMOND COATED

Rod sharpens  
both sides  
together



### ADAPTABLE MOUNTING

Base can be  
screwed down  
or clamped on



ITEM	DESCRIPTION	UOM	CASE
KSP-6	Sharpener	Set	1/6
KSP-6W	Replacement Sharpening Rods, 3-pcs/pk	Set	12/72



"The Blade Station knife sharpener is  
**the only thing** at Chicago NRA show  
I had to have."

**Chef Brad Emel**

*Seabrook Classic Cafe, Seabrook, TX*





**FOUR-STAGE KNIFE SHARPENER**

When you need to sharpen standard or Asian style knives, look no further than this one tool for the job. Designed for the commercial kitchen, the wide, rubberized base provides stability for any busy chef to sharpen their favorite knife.

- ◆ For either standard or Asian style knives; coarse stages quickly sharpen dull knives, while fine stages hone to a razor sharp edge
- ◆ Reduced wobbling - the safest sharpener with oversized non-slip base
- ◆ Most ergonomic handle available for comfort, slip-resistance and excellent grip control

ITEM	DESCRIPTION	UOM	CASE
KSP-4	9-7/8"L x 2-5/8"W x 3-3/4"H	Each	12/24



KSP-4 Packaging



**FOUR-STAGE KNIFE SHARPENER**



#aceofblades



**PATENTED**



KSP-4

**DUAL-STAGE KNIFE SHARPENER**

- ◆ Soft-grip ergonomic handle with non-skid base
- ◆ Coarse carbide steel blades for sharpening and ceramic rods for honing

ITEM	DESCRIPTION	UOM	CASE
KSP-2	7-5/8"L x 2-1/2"W x 2"H	Each	12/48

**DUAL-STAGE KNIFE SHARPENER**



KSP-2

## SHARPENING STEELS



#aceofblades



NSF KFP-122



NSF KFP-123



NSF K-34S



NSF K-54S



NSF K-12S



NSF K-14S

## SHARPENING STONES & GUIDE

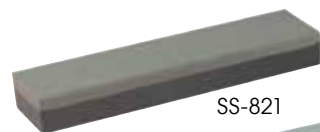

SS-821



SS-1211



K-4G



K-4G in use



## ACERO DIAMOND STEEL SHARPENERS

Durable and long lasting, these diamond coated steel rods sharpen knives faster than conventional stones. The extra-fine grit allows for regular honing or final polishing.

◆ NSF listed

ITEM	DESCRIPTION	LENGTH	UOM	CASE
KFP-122	20mm Width, Oval	12"	Each	6/24
KFP-123	12mm Dia, Round	12"	Each	6/24



Shape of KFP-122



## PREMIUM SHARPENING STEELS

Made of super hard HRC59-63 steel, these magnetic sharpening steels attract metal shavings during the sharpening process to prevent debris from sticking to knives and getting onto food.

◆ NSF listed

ITEM	DESCRIPTION	LENGTH	UOM	CASE
K-34S	13mm Dia, Round	14"	Each	6/24
K-54S	22mm Width, Oval	14"	Each	6/24

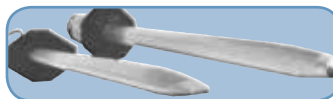

## SHARPENING STEELS

◆ NSF listed

ITEM	DESCRIPTION	LENGTH	UOM	CASE
K-12S	Stainless Steel	12"	Each	12/48
K-14S	Stainless Steel	14"	Each	12/48

## COMBINATION SHARPENING STONE

- ◆ Top-grade carbonized silicon
- ◆ Fine and medium grain



ITEM	DESCRIPTION	UOM	CASE
SS-821	8"L x 2"W x 1"H	Each	1/24
SS-1211	12"L x 2-1/2"W x 1-1/2"H	Each	1/12



## SHARPENING GUIDE WITH CERAMIC INSERTS

Sharpening knives has never been easier! Sharpening guides by Winco keep knives at the optimal angle while using sharpening stones.

- ◆ Ideal sharpening angle for ultimate knife performance
- ◆ Durable plastic body with protective ceramic inserts
- ◆ For use with 6" and larger chef's knives

ITEM	DESCRIPTION	UOM	CASE
K-4G	Sharpening Guide	Each	12/144

### SOF-TEK™ ALL-PURPOSE UTILITY KNIFE

A new angle on the utility knife for the ultimate in kitchen prep. Full of features, this handy little knife is outfitted with a soft-grip handle, a thumb groove for precision handling, and a partial serrated edge to easily pierce skins and peels,

- ◆ Angled soft-touch, non-slip handle keeps knuckles off cutting surface
- ◆ Thumb groove for added leverage
- ◆ Serrated edge ideal for piercing tough peels

ITEM	DESCRIPTION	UOM	CASE
KPR-30	3-1/2" L Blade	Doz	1/4



Thumb groove



Pierce tough peels



Serrated edge

### PP WHITE HANDLE PARING KNIFE

- ◆ NSF listed

ITEM	DESCRIPTION	UOM	CASE
K-40P	3" L Blade	Each	12/360



K-40P NSF

## UTILITY KNIVES



EACH PIECE IS  
LABELED FOR  
INDIVIDUAL  
SALE



KPR-30



Retail display holds 12 pieces

### STAINLESS STEEL PROTECTIVE MESH GLOVES

Made for meat processing, the rust-resistant 304L stainless steel rings that form these mesh gloves protect hands from cuts and punctures while deboning and butchering. Each glove is reversible and is fixed with a wrist strap that features a snap and cinch fastener to keep it secure.

- ◆ Light-weight and non-corrosive
- ◆ Wrist length

ITEM	DESCRIPTION	UOM	CASE
PMG-1S	Small, White Strap	Each	10/50
PMG-1M	Medium, Red Strap	Each	10/50
PMG-1L	Large, Blue Strap	Each	50



Closure Detail



Mesh Detail



PMG-1L

## PROTECTIVE GLOVES

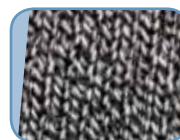

Fabric Detail



### ANTI-MICROBIAL CUT-RESISTANT GLOVES

Reduce cuts from sharp edges or a slip of the knife during food prep with these comfortable cut-resistant gloves. High-density fibers are strong, flexible and durable.

- ◆ Anti-microbial yarn reduces bacterial growth
- ◆ Color-coded wristband for quick size identification
- ◆ FDA approved materials for direct food contact

ITEM	DESCRIPTION	WRISTBAND	UOM	CASE
GCRA-S	Small	Red	Each	12/120
GCRA-M	Medium	Green	Each	12/120
GCRA-L	Large	Gray	Each	12/120
GCRA-XL	Extra Large	Black	Each	12/120

### CUT-RESISTANT GLOVES

ITEM	DESCRIPTION	UOM	CASE
GCR-M	Medium	Each	12/120
GCR-L	Large	Each	12/120



GCR-M

AMBIDEXTROUS



GCRA-M

NEW

ANTI-MICROBIAL

AVAILABLE IN  
JULY 2020

**CAUTION:** cut-resistant gloves are not cut-proof or puncture resistant. Do not use with/near serrated or moving blades.

KITCHEN SHEARS

 **KITCHEN SHEARS**

ITEM	DESCRIPTION	UOM	CASE
KS-01	All Purpose	Each	12/120
KS-06	All Purpose, Detachable	Each	12/72



KS-01



Built-in bottle cap opener

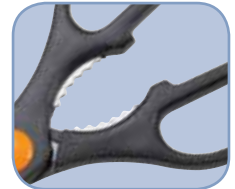

Built-in cracker or bottle cap grip



#aceofblades



KS-06



KS-06 is detachable



Built-in cracker or bottle cap grip



Built-in bottle cap opener

 **POULTRY SHEARS**

ITEM	DESCRIPTION	UOM	CASE
KS-02	Soft-Grip PP HdI	Each	12/72
KS-03	Stainless Steel	Each	10/50



KS-02



Locks closed



KS-03



Locks closed

 **HERB SHEARS**

*Chopping fresh herbs is now easy with these shears featuring five (5) durable stainless steel blades.*

- ◆ Works well on basil, thyme, mint and more
- ◆ Ideal for cutting, chopping and mincing herbs
- ◆ Comfortable PP and TPR handles for easy grip



KS-05



Cut, chop, mince herbs

ITEM	DESCRIPTION	UOM	CASE
KS-05	5-Layer Blade	Each	12/72

PROFESSIONAL CLEAVERS

- ACERO EXTRA HEAVY-DUTY CLEAVER**
  - ◆ Full tang, true forged, ice tempered blade
  - ◆ Triple riveted handle
  - ◆ NSF listed

ITEM	DESCRIPTION	UOM	CASE
KFP-72	7"L x 4-3/8"W Blade	Each	6/24



#aceofblades



KFP-72 NSF

- HEAVY-DUTY CLEAVER**
  - ◆ Wooden handle

ITEM	DESCRIPTION	UOM	CASE
KC-301	8"L x 3-1/2"W Blade	Each	6/24



KC-301

- STEEL HANDLE CHINESE CLEAVERS**
  - ◆ NSF listed

ITEM	DESCRIPTION	UOM	CASE
KC-401	8-1/4"L x 4"W Blade	Each	12/36
KC-501	8"L x 2-1/4"W Blade	Each	10/50



KC-401 NSF



KC-501 NSF

- POM HANDLE CHINESE CLEAVER**
  - ◆ NSF listed

ITEM	DESCRIPTION	UOM	CASE
KC-601	8"L x 3-1/2"W Blade	Each	6/36



KC-601 NSF

- WOODEN HANDLE CHINESE CLEAVERS**

ITEM	DESCRIPTION	UOM	CASE
KC-101	8"L x 3-1/2"W Blade	Each	12/24
KC-201R	7"L x 2"W Blade	Each	12/48



KC-101



KC-201R

## KNIFE BLADE GUARDS



#aceofblades



KGD-41



KGD-815

## KNIFE BLADE GUARDS



Safely store and transport knives with the durable blade guards from Winco®.

- ◆ Ideal for stamped or forged blades
- ◆ Felt interior prevents dulling

ITEM	DESCRIPTION	SIZE	UOM	CASE
KGD-41	Fits 2-1/2" to 3-1/2" blade, 2-Pcs/Pk	4" x 1"	Pack	12/72
KGD-61	Fits 5" to 6" blade, 2-Pcs/Pk	6" x 1"	Pack	12/72
KGD-62	Fits 6" blade	6" x 2"	Each	12/72
KGD-815	Fits 7" to 8" blade	8" x 1-1/2"	Each	12/72
KGD-82	Fits 7" to 8" blade	8" x 2"	Each	12/72
KGD-1015	Fits 10" blade	10" x 1-1/2"	Each	12/72
KGD-102	Fits 9" to 10" blade	10" x 2"	Each	12/72
KGD-122	Fits 11" to 12" blade	12" x 2"	Each	12/72

Can be used with bolsters and angled-handle knives



KGD-41 with KWP-30 knife



KGD-815 with KFP-80 knife

## KNIFE STORAGE



### MAGNETIC KNIFE BARS

ITEM	DESCRIPTION	UOM	CASE
WMB-12	12", Wooden Base	Each	1/36
WMB-18	18", Wooden Base	Each	1/24
WMB-24	24", Wooden Base	Each	1/24
PMB-13	13", Plastic Base	Each	1/36
PMB-18	18", Plastic Base	Each	1/36
PMB-24	24", Plastic Base	Each	1/24



WMB-18



PMB-18



KR-9

### STAINLESS STEEL KNIFE RACK

- ◆ Hooks onto wall

ITEM	DESCRIPTION	UOM	CASE
KR-9	7 Slots	Each	1/12

**KNIFE BACKPACK & INNER CASE**

For the chef-on-the-go, Winco® introduces the ideal, multi-functional backpack. As a stand-alone, the backpack has an array of useful features, from laptop sleeve to audio interface. Used with the knife case, this combo easily solves every chef's dilemma of how to safely and securely transport knives.

- ◆ Backpack features wide, ergonomic straps with a back airflow system for extra comfort
- ◆ Padded laptop sleeve compartment with locking zippers
- ◆ Perfectly accommodates Winco's KBP-2 hard case
- ◆ The KBP-2 hard case has 10 slots to fit a variety of knives; has removable strap, which can be used for carrying without backpack

**KNIFE BACKPACK & INNER CASE**



#aceofblades



KBP-S

Backpack and Inner Case set



ITEM	DESCRIPTION	UOM	CASE
KBP-1	Backpack	Each	12
KBP-2	Inner Case	Each	12
KBP-S	Backpack w/Inner Knife Case	Set	4



HARD CASE

KBP-2



KBP-1

- Easy-access lined top pocket fits glasses or cell phone
- Wide, ergonomic shoulder straps with zippered stash pocket
- Lockable zippers on compartment that fits a standard laptop
- Securely lock zippers on large main compartment
- Audio interface and zipper pocket on front
- Airflow back system for extra comfort
- Internal zipper pockets for wallet or valuables
- Wide mesh pocket on each side, great for water bottle

**KNIFE BAGS**

ITEM	DESCRIPTION	UOM	CASE
KBG-8	8 Slot Knife Roll	Each	24
KBG-11*	11 Slot Knife Bag	Each	12
KBG-29	29 Slot Triple-Zip Knife Bag	Each	12

\* Replaces former KBG-10

**KNIFE BAGS**



KBG-29



KBG-11



KBG-8

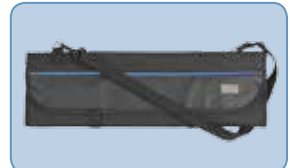

# SPATULAS & TURNERS

- ◆ Stainless steel, satin finish blade
- ◆ Ergonomic handle with slip-free comfort grip reduces hand fatigue
- ◆ Dishwasher safe
- ◆ NSF listed (TNH-Series)

**SAME QUALITY AS OTHERS FOR MUCH LESS**



DESCRIPTION	BLADE SIZE (L X W)	UOM	HIGH-HEAT ORANGE NYLON ERGO HANDLE		WOODEN HANDLE	
			ITEM	CASE	ITEM	CASE
Mini Turner	2" x 2-1/4"	* Each			TN32	12/120
Sandwich Spreader	3-5/8" x 1-1/4"	Each			TN713	12/144
Small Scraper	4-1/2" x 3-1/8"	Each			TN526	12/72
Large Scraper	4-7/8" x 4"	Each			TN54	12/72
Steak/Burger Turner	4-1/8" x 3-3/4"	* Each			TN46	12/72
Turner	8" x 4"	Each	TNH-42	12/48	TN48	12/24
Grill Spatula	4-1/4" x 2-3/16"	* Each			TN165	12/72
Teppanyaki Turner, Full Tang	4" x 3-1/2"	* Each			TN43	12/72
Pie Server	4-5/8" x 2-3/8"	* Each			TN166	12/72
Fish Spatula	6-3/4" x 3-1/4"	Each	TNH-60	12/144	FST-6	12/144
Hamburger Turner	5-1/8" x 2-7/8"	* Each	TNH-61	12/72	TN719	12/72
Extra Heavy Turner, Cutting Edge Blade	5" x 6"	* Each	TNH-63	12/48	TN56	12/48
Square Edge Turner	6-1/4" x 3"	* Each	TNH-64	12/72		
Square Edge Turner	7-1/4" x 3"	* Each	TNH-70	12/48		
Flexible Turner	8-1/4" x 2-7/8"	* Each	TNH-90	12/48	TN249	12/48
Flexible Turner (Perforated Blade)	8-1/4" x 2-7/8"	* Each	TNH-91	12/48	TN409	12/48
Offset Giant Turner	8-1/2" x 2-7/8"	* Each			TN44	12/48
Offset Spatula	3-1/2" x 3/4"	* Each			TOS-4	24/288
Offset Spatula	6-1/2" x 1-5/16"	* Each			TOS-7	12/144
Offset Spatula	8-1/2" x 1-1/2"	* Each			TOS-9	12/72
Bakery Spatula	4" x 3/4"	Each			TNS-4	24/288
Bakery Spatula	7-15/16" x 1-1/4"	Each			TNS-7	12/144
Bakery Spatula	10" x 1-3/8"	Each			TNS-9	12/72

\*Measurement reflects blade size not including offset

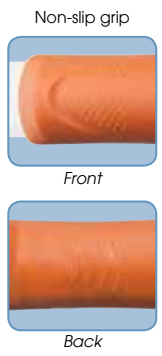
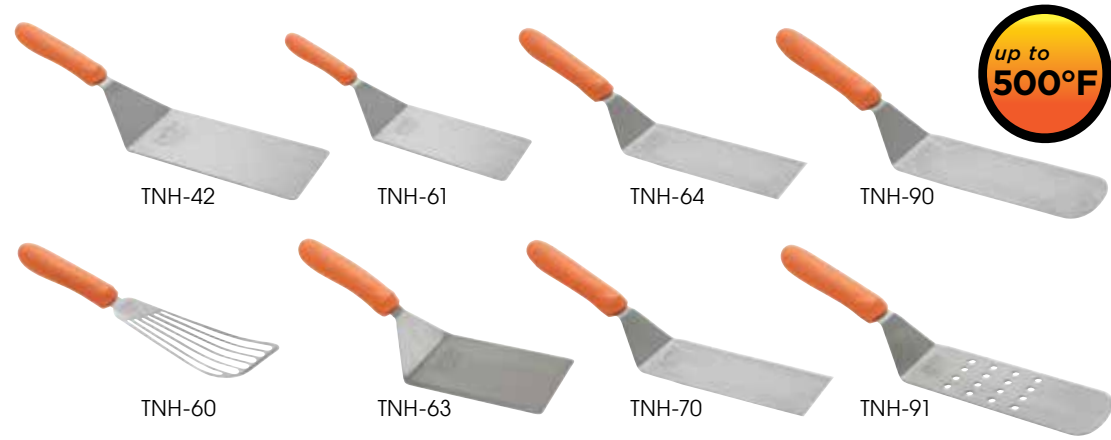

**NSF** TNH-SERIES (ORANGE)



Relative size comparisons shown



# SPATULAS & TURNERS

- ◆ Stainless steel, satin finish blade
- ◆ Ergonomic handle with slip-free comfort grip reduces hand fatigue
- ◆ Dishwasher safe
- ◆ NSF listed



TKP-SERIES (BLACK) **NSF**

TWP-SERIES (WHITE) **NSF**

DESCRIPTION	BLADE SIZE (L X W)	UOM	BLACK ERGO HANDLE		WHITE ERGO HANDLE	
			ITEM	CASE	ITEM	CASE
Mini Turner	2" x 2-1/4"	* Each	TKP-30	12/120	TWP-30	12/120
Sandwich Spreader	3-5/8" x 1-1/4"	Each	TKP-31	12/144	TWP-31	12/144
Small Scraper	4-1/2" x 3-1/8"	Each	TKP-32	12/72	TWP-32	12/72
Large Scraper	4-7/8" x 4"	Each	TKP-40	12/72	TWP-40	12/120
Steak/Burger Turner	4-1/8" x 3-3/4"	* Each	TKP-41	12/72	TWP-41	12/72
Turner	8" x 4"	Each	TKP-42	12/48	TWP-42	12/48
Grill Spatula	4-1/4" x 2-3/16"	* Each	TKP-50	12/72	TWP-50	12/72
Pie Server	4-5/8" x 2-3/8"	* Each	TKP-51	12/72	TWP-51	12/72
Fish Spatula	6-3/4" x 3-1/4"	Each	TKP-60	12/144	TWP-60	12/144
Hamburger Turner	5-1/8" x 2-7/8"	* Each	TKP-61	12/72	TWP-61	12/72
Extra Heavy Turner, Cutting Edge Blade	5" x 6"	* Each	TKP-63	12/48		
Flexible Turner	8-1/4" x 2-7/8"	* Each	TKP-90	12/72	TWP-90	12/48
Flexible Turner (Perforated Blade)	8-1/4" x 2-7/8"	* Each	TKP-91	12/72	TWP-91	12/48
Offset Spatula	3-1/2" x 3/4"	* Each	TKPO-4	24/288	TWPO-4	24/288
Offset Spatula	6-1/2" x 1-5/16"	* Each	TKPO-7	12/144	TWPO-7	12/144
Offset Spatula	8-1/2" x 1-1/2"	* Each	TKPO-9	12/144	TWPO-9	12/144
Bakery Spatula	4" x 3/4"	Each	TKPS-4	24/288	TWPS-4	24/288
Bakery Spatula	7-15/16" x 1-1/4"	Each	TKPS-7	12/144	TWPS-7	12/144
Bakery Spatula	10" x 1-3/8"	Each	TKPS-9	12/144	TWPS-9	12/72

\*Measurement reflects blade size not including offset



Allergen Free  
SEE PAGE 297 FOR ALLERGEN-FREE PURPLE HANDLES



TKP-30



TKP-31



TKP-32



TKP-40



TKP-41



TKP-42



TKP-50



TKP-51



TKP-60



TKP-61



TKP-63



TKP-90



TKP-91



TKPO-9



TKPS-9

## PIZZA CUTTERS



**NEW**



**NSF** KSTK-40



PWC-4



PPC-4



VP-316



PPC-4W

**NSF** PPC & VP-SERIES



**NSF** KPP-18



**NSF** KPP-20

### SOFT-TEK™ PIZZA CUTTER

The specially designed soft-touch, non-slip handle of the Sof-Tek™ series is now available as a pizza cutter.

- ◆ Razor sharp 4" diameter blade
- ◆ Protective finger guard

ITEM	DESCRIPTION	BLADE	UOM	CASE
KSTK-40	Sof-Tek Handle	4" Dia	Each	6/36

### PIZZA CUTTERS

- ◆ NSF listed (plastic handles)

ITEM	DESCRIPTION	BLADE	UOM	CASE
PWC-4	Wooden Handle	4" Dia	Each	12/72
PPC-2	Black PP Handle, NSF	2-1/2" Dia	Each	12/72
PPC-4	Black PP Handle, NSF	4" Dia	Each	12/72
PPC-2W	White Handle, NSF	2-1/2" Dia	Each	12/72
PPC-4W	White Handle, NSF	4" Dia	Each	12/72
VP-315	Soft Grip Handle, NSF	2-1/2" Dia	Each	12/72
VP-316	Soft Grip Handle, NSF	4" Dia	Each	12/72

### PIZZA KNIVES

- ◆ NSF listed

ITEM	DESCRIPTION	UOM	CASE
KPP-18	18" Pizza Knife	Each	6/24
KPP-20	20" Pizza Rocker Knife	Each	6/24

## CHOPPING KNIVES



KCC-3



KCC-4



**NSF** KCC-1



**NSF** KCC-2

### MEZZALUNA CHOPPING KNIVES

- ◆ Rock the crescent-shaped blade side-to-side to effortlessly chop tender herbs and greens
- ◆ Use an up-and-down motion to chop larger, more dense vegetables
- ◆ Ergonomic design allows you to chop effortlessly
- ◆ Durable 18/8 stainless steel

ITEM	DESCRIPTION	UOM	CASE
KCC-3	Single Blade	Each	12/72
KCC-4	Double Blade	Each	12/72

### CHOPPING KNIVES

- ◆ Use flat blade on cutting boards to chop and mince food
- ◆ Use rounded edges inside mixing bowls to cut and fold ingredients
- ◆ Dishwasher safe
- ◆ NSF listed

ITEM	DESCRIPTION	UOM	CASE
KCC-1	Single Blade	Each	6/72
KCC-2	Double Blade	Each	6/48

## OYSTER/CLAM KNIVES

**NSF** VP-314



**NSF** KCL-5P



KCL-1



KCL-2



KCL-3



### OYSTER/CLAM KNIVES

ITEM	DESCRIPTION	SIZE	UOM	CASE
VP-314	2-7/8" Blade, Soft Rubber Grip NSF	7-5/8" O.L.	Each	12/72
KCL-5P	3" Blade, Plastic Handle, NSF	6-3/4" O.L.	Each	12/72
KCL-1	2-3/4" Blade, Wooden Handle	5-7/8" O.L.	Each	12/72
KCL-2	2-7/8" Blade, Wooden Handle	6-5/8" O.L.	Each	12/72
KCL-3	3-1/2" Blade, Wooden Handle	7-1/2" O.L.	Each	12/72

### DOUBLE HANDLE CHEESE KNIFE

◆ NSF listed

ITEM	DESCRIPTION	UOM	CASE
KCP-15	15"L, Double PP Handles	Each	6/24

### CHEESE CUTLERY



KCP-15 NSF

### WIRE CHEESE SLICERS

- ◆ Provides a smoother cut than cheese knives
- ◆ Wire is 44" long 18/8 stainless steel
- ◆ Customized control over slicing thickness and angle
- ◆ Easy cleanup

ITEM	DESCRIPTION	UOM	CASE
CS-44P	Polyethylene Handles	Each	24/144
CS-44W	Wooden Handles	Each	24/144



CS-44P

CS-44W

### CAST ALUMINUM CHEESE SLICER

ITEM	DESCRIPTION	UOM	CASE
ACS-4	5" Wide Blade, S/S Wire	Each	12/36



ACS-4

### CHEESE PLANE

- ◆ Comfortable non-slip soft-grip handle
- ◆ Dishwasher safe
- ◆ NSF listed

ITEM	DESCRIPTION	UOM	CASE
VP-309	Stainless Steel	Each	12/72



VP-309 NSF

### ERGONOMIC HANDLE CHEESE GRATERS

- ◆ Extra strength wire frame resists bending
- ◆ Comfortable non-slip soft-grip handle
- ◆ Dishwasher safe
- ◆ NSF listed

ITEM	DESCRIPTION	UOM	CASE
VP-311	Small Holes, 1.5mm Dia	Each	12/72
VP-312	Medium Holes, 3mm Dia	Each	12/72
VP-313	Large Holes, 6mm Dia	Each	12/72



VP-311



VP-312



VP-313

VP-SERIES NSF

### STAINLESS STEEL CHEESE GRATER

- ◆ 18/8 stainless steel rotary grater with one drum for grating fine cheeses

ITEM	DESCRIPTION	UOM	CASE
GRTS-1	8-1/4"L x 4-3/4"W x 3-3/8"H	Each	12/36



GRTS-1

### PLASTIC CHEESE GRATER

ITEM	DESCRIPTION	UOM	CASE
PRTS-2	Cheese Grater	Each	6/24



PRTS-2

### CHEESE KNIFE SETS

*Whether it's for a wine tasting event or to accompany dessert, elegantly present and serve a full range of cheeses with these 6-piece cheese knife sets.*

- ◆ Each set includes six (6) knives for hard, soft, firm, crumbly cheeses
- ◆ Stainless steel blades

ITEM	DESCRIPTION	UOM	CASE
KCS-6	6-Pc Set w/POM Hdls	Set	1/24
KCS-6W	6-Pc Set w/Wooden Hdls	Set	6/48



KCS-6



KCS-6W

STEAK KNIVES



4 Piece Boxed Set

NSF SK-1



ACERO STEAK KNIVES

A Winco® exclusive, these heavyweight knives are a must-have on the tables of any steak house. With its sharp serrated edge and pointed tip, the Acero knife is designed to make simple work of cutting through steaks and chops. A stainless steel end cap provides excellent balance and control.

ITEM	DESCRIPTION	BLADE	UOM	CASE
SK-22	Acero Gourmet Steak Knives, Round Tip	5"	Doz	1/6
SK-12	Acero Gourmet Steak Knives, 12-pc Bulk Pack	5"	Doz	1/6
SK-1	Acero Gourmet Steak Knives, 4-pc Gift Pack	5"	Pack	1/6



NSF SK-22



NSF SK-12



NSF K-81P



JUMBO PLASTIC HANDLE STEAK KNIVES

Complete steak house table settings with these attractive and durable steak knives.

◆ NSF listed

ITEM	DESCRIPTION	BLADE	UOM	CASE
K-81P	Round Tip, Solid POM Hdl	4-3/4"	Pack	6/12
K-85P	Round Tip, Plastic Hdl	5"	Doz	1/12



NSF K-85P



K-81P  
6-piece  
Jumbo  
steak knives  
packaging



K-70P



K-71P



K-80P

SOLID POM HANDLE STEAK KNIVES

ITEM	DESCRIPTION	BLADE	UOM	CASE
K-70P	Pointed Tip, POM Hdl	5"	Doz	1/24
K-71P	Round Tip, POM Hdl	4-1/2"	Doz	1/24
K-80P	Round Tip, POM Hdl	5"	Doz	1/25



NSF K-60P

PLASTIC HANDLE STEAK KNIVES

◆ NSF listed

ITEM	DESCRIPTION	BLADE	UOM	CASE
K-60P	Pointed Tip	5"	Doz	1/24
K-50P	Round Tip	5"	Doz	1/48



NSF K-50P



### EURO SLIM STEAK KNIFE

Attractive and sturdy, the euro slim steak knife offers elegance and function.

◆ 12 pcs packaged in hanging clear-view pack

ITEM	DESCRIPTION	BLADE	UOM	CASE
K-73PC	Pointed Tip, ABS Handle, 3 Rivets	4-1/2"	Doz	1/24

Replaces K-73P

### STEAK KNIVES



Serrated blade



Metal plaque detail



NEW PACKAGING

K-73PC  
12-piece Euro-slim handle knives hanging clear pack



K-73PC



### JUMBO WOODEN HANDLE STEAK KNIVES

Bring a refined rustic aesthetic to steak house table settings with wooden handle steak knives.



ITEM	DESCRIPTION	BLADE	UOM	CASE
K-82	Pointed Tip, Polywood Handle, 3 Rivets	4-3/4"	Pack	6/12
KB-15W	Round Tip, Oak Wood Handle	5"	Doz	1/12
KB-30W	Pointed Tip, Oak Wood Handle	5"	Doz	1/12



K-82  
6-piece Polywood handle steak knives packaging



K-82



KB-15W



KB-30W

### WOODEN HANDLE STEAK KNIVES

ITEM	DESCRIPTION	BLADE	UOM	CASE
K-55W	Rounded Tip	4-1/2"	Doz	1/48
K-45W	Pointed Tip	4-1/2"	Doz	1/48
K-438W	Pointed Tip and Handle	4-3/8"	Doz	1/24
K-35W	Economy, Pointed Tip	4"	Doz	1/48



K-55W



K-45W



K-438W



K-35W



# WINCO® CUTLERY MERCHANDISING DISPLAYS

**FREE DISPLAY**  
available with **qualifying order**  
*1 display per location*

## ACERO



## STÄL



## SOF-TEK™



Each rack includes hooks to hang product,  
(1) header sign and (2) header clips.

INDUCTION-READY

# TRI-GEN™

by **winco**®

TRI-GEN™  
COOKWARE

## NEXT GENERATION COOKWARE

NSF®



Fry Pans  
Sauté Pans  
Sauce Pans  
Stock Pots  
Braziers

HANDLE WITH  
**Comfort  
and  
Purpose**





**EXCALIBUR**  
Non-stick finish

Excalibur non-stick finish is reinforced externally with a proprietary stainless-steel alloy

**Highest performing commercial coating available**



**TRI-PLY INDUCTION-READY FRY PANS**

- ◆ Handles offer excellent comfort and pan control, minimizing hand fatigue for high-volume operators
- ◆ Triangular positioned rivets provide strength - will not loosen in high-volume commercial kitchens
- ◆ Available in natural and Excalibur® non-stick finishes
- ◆ Five (5) sizes available
- ◆ NSF listed

ITEM	DESCRIPTION	SIZE	UOM	CASE
TGFP-7	Natural Finish	7"	Each	1/6
TGFP-7NS	Non-stick	7"	Each	1/6
TGFP-8	Natural Finish	8"	Each	1/6
TGFP-8NS	Non-stick	8"	Each	1/6
TGFP-10	Natural Finish	10"	Each	1/6
TGFP-10NS	Non-stick	10"	Each	1/6
TGFP-12	Natural Finish	12"	Each	1/2
TGFP-12NS	Non-stick	12"	Each	1/2
TGFP-14	Natural Finish	14"	Each	1/2
TGFP-14NS	Non-stick	14"	Each	1/2

7"



8"



12"



10"



14"



TGFP-SERIES



NON-STICK FRY PANS

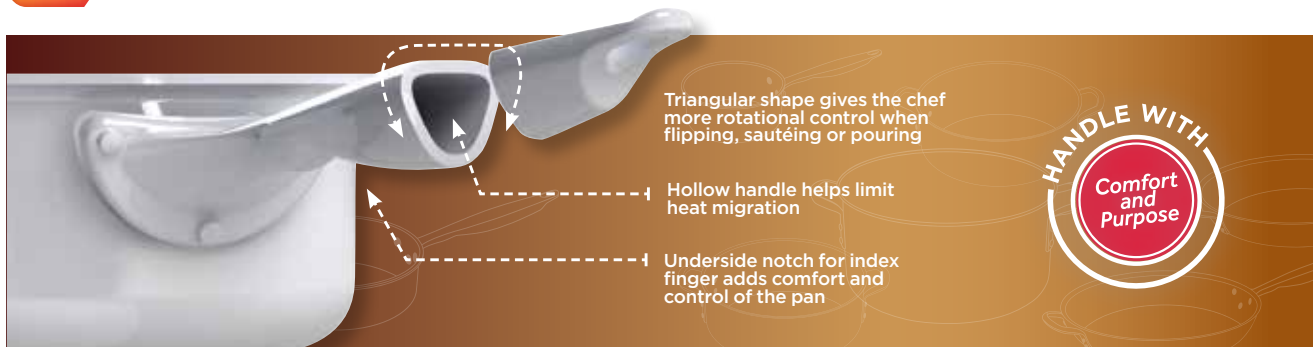



**TRI-PLY INDUCTION-READY SAUCE PANS**

- ◆ Perfect for preparing many dishes with style and comfort
- ◆ Triangular positioned rivets provide strength - will not loosen in high-volume commercial kitchens
- ◆ Mirror finish exterior; satin finish interior
- ◆ Five (5) sizes available
- ◆ NSF listed

ITEM	DESCRIPTION	SIZE	DIA	UOM	CASE
TGAP-2	Sauce Pan w/ Cover	1.5 Qt	6"	Set	1/6
TGAP-3	Sauce Pan w/ Cover	2.5 Qt	7"	Set	1/6
TGAP-4	Sauce Pan w/ Cover	3.5 Qt	8"	Set	1/4
TGAP-5	Sauce Pan w/ Cover	4.5 Qt	8.5"	Set	1/4
TGAP-7	Sauce Pan w/ Cover, Helper Hdl	7 Qt	9.5"	Set	1/2

Handles built for comfort and purpose.



TGAP-5  
17-3/8"L x 9-1/4"W including handle  
5-1/8"H pan only



TGAP-2  
14-1/2"L x 7"W including handle  
3-5/8"H pan only



TGAP-3  
15-1/8" x 7-3/4" including handle  
4-1/8" pan only



TGAP-7  
19-7/8"L x 10"W including handles  
6-1/2"H pan only



TGAP-4  
16-5/8" x 8-1/2" including handle  
4-3/4" pan only

TGAP-SERIES  

Visually stunning  
 Highly functional

**TRI-PLY INDUCTION-READY SAUTÉ PANS**

- ◆ Deep, straight sides for easy stirring, mixing or flipping food without spilling
- ◆ Sauté, brown or stir-fry with ease
- ◆ Mirror finish exterior; satin finish interior
- ◆ Four (4) sizes available
- ◆ NSF listed

ITEM	DESCRIPTION	SIZE	DIA	UOM	CASE
TGET-2	Sauté Pan w/ Cover	2 Qt	8"	Set	1/6
TGET-3	Sauté Pan w/ Cover	3 Qt	9.5"	Set	1/6
TGET-6	Sauté Pan w/ Cover, Helper Hdl	6 Qt	12.5"	Set	1/4
TGET-7	Sauté Pan w/ Cover, Helper Hdl	7 Qt	14"	Set	1/2

2qt



TGET-2

16-5/8"L x 8-1/2"W  
 including handle  
 3-1/4"H pan only

6qt



TGET-6

24-1/4"L x 13-1/8"W  
 including handles  
 4-1/8"H pan only

3qt



TGET-3

18-1/8"L x 10"W  
 including handle  
 3-5/8"H pan only

7qt



TGET-7

26-1/8"L x 15"W  
 including handles  
 4"H pan only



TGET-SERIES



Triangular shaped handle with outward sloping top provides the chef with better control and a more comfortable thumb rest.

Compatible with Induction, Gas & Electric



**TRI-PLY INDUCTION-READY STOCK POTS**

- ◆ Larger sizes for higher volume food preparation
- ◆ Securely riveted wide loop handles provide excellent stability, especially for larger hands when handling with hot pads
- ◆ Mirror finish exterior; satin finish interior
- ◆ Six (6) sizes available
- ◆ NSF listed



Strength  
& Balance

ITEM	DESCRIPTION	SIZE	DIA	UOM	CASE
TGSP-4	Stock Pot w/Cover	4.5 Qt	8.5"	Set	1/6
TGSP-6	Stock Pot w/Cover	6 Qt	8.5"	Set	1/6
TGSP-8	Stock Pot w/Cover	8 Qt	9.5"	Set	1/6
TGSP-12	Stock Pot w/Cover	12 Qt	12"	Set	1/4
TGSP-16	Stock Pot w/Cover	16 Qt	12.5"	Set	1/4
TGSP-20	Stock Pot w/Cover	20 Qt	14"	Set	1/4

12qt



TGSP-12  
16-1/2"W including handles  
7-1/4"H pot only

4.5qt



TGSP-4  
13"W including handles  
5-1/4"H pot only

16qt



TGSP-16  
17-1/4"W including handles  
8-1/4"H pot only

6qt



TGSP-6  
13"W including handles  
6-5/8"H pot only

20qt





TGSP-20  
19"W including handles  
8-1/4"H pot only

8qt



TGSP-8  
13-3/4"W including handles  
7-3/8"H pot only

TGSP-SERIES  

-  Induction
-  Gas
-  Electric

 **TRI-PLY INDUCTION-READY BRAZIER**

- ◆ Larger sizes for higher volume food preparation
- ◆ Securely riveted wide loop handles provide excellent stability, especially for larger hands when handling with hot pads
- ◆ Mirror finish exterior; satin finish interior
- ◆ Two (2) sizes available
- ◆ NSF listed

ITEM	DESCRIPTION	SIZE	DIA	UOM	CASE
TGBZ-12	Brazier w/Cover	12 Qt	13.5"	Set	1/4
TGBZ-14	Brazier w/Cover	14 Qt	14"	Set	1/4

12qt



TGBZ-12

18"W including handles  
5-1/2"H brazier only

14qt



TGBZ-14

19"W including handles  
6"H brazier only



TGBZ-SERIES

Packaging





## PREMIUM STAINLESS STEEL COOKWARE

- ◆ Commercial-quality 18/8 stainless steel offers excellent corrosion resistance and a bright finish
- ◆ Tri-ply heavy-duty bottom for even heat distribution
- ◆ Extra sturdy 6-point welding on handles
- ◆ Induction ready
- ◆ NSF listed



PREMIUM STAINLESS STEEL COOKWARE

### STOCK POTS WITH COVER INCLUDED

ITEM	DESCRIPTION	SIZE (DIA X HEIGHT)	UOM	CASE
SST-8	8 Qt	9-1/2" x 6-3/4"	Set	1/4
SST-12	12 Qt	11" x 7-1/8"	Set	1/4
SST-16	16 Qt	11" x 9-3/4"	Set	1/4
SST-20	20 Qt	11-3/4" x 10-1/4"	Set	1/4
SST-24	24 Qt	13-3/8" x 10-1/4"	Set	1/2
SST-32	32 Qt	14-1/4" x 11-3/4"	Set	1/2
SST-40	40 Qt	15-3/4" x 11-3/4"	Set	1/2
SST-60	60 Qt	17-3/4" x 14-1/4"	Set	1
SST-80	80 Qt	19-3/4" x 15-3/4"	Set	1

### REPLACEMENT COVERS

ITEM	UOM	CASE
SSTC-8	Each	6/12
SSTC-12	Each	6/12
SSTC-12	Each	6/12
SSTC-20	Each	6/12
SSTC-24	Each	6
SSTC-32	Each	6
SSTC-40	Each	6
SSTC-60	Each	6
SSTC-80	Each	6

### SAUCE PANS WITH COVER INCLUDED

ITEM	DESCRIPTION	SIZE (DIA X HEIGHT)	UOM	CASE
SSSP-2	2 Qt	6-3/8" x 3-3/4"	Set	1/6
SSSP-3	3 -1/2 Qt	8" x 4-1/4"	Set	1/6
SSSP-4	4 -1/2 Qt	8" x 5-1/2"	Set	1/6
SSSP-6	6 Qt	9-1/2" x 5"	Set	1/6
SSSP-7	7 -1/2 Qt w/Hdl	9-1/2" x 6-1/8"	Set	1/2
SSSP-10	10 Qt w/Hdl	11" x 6-1/8"	Set	1/2

### REPLACEMENT COVERS

ITEM	UOM	CASE
SSTC-2	Each	6
SSTC-8F	Each	6/12
SSTC-8F	Each	6/12
SSTC-8	Each	6/12
SSTC-8	Each	6/12
SSTC-12	Each	6/12

### BRAZERS WITH COVER INCLUDED

ITEM	DESCRIPTION	SIZE (DIA X HEIGHT)	UOM	CASE
SSLB-8	8 Qt	11" x 5-1/8"	Set	1/4
SSLB-10	10 Qt	11-11/16" x 5-1/2"	Set	1/4
SSLB-15	15 Qt	14-1/4" x 5-1/2"	Set	1/4
SSLB-20	20 Qt	15-3/4" x 6"	Set	1/4
SSLB-25	25 Qt	17-3/4" x 6"	Set	1/2
SSLB-30	30 Qt	19-3/4" x 6"	Set	1/2

### REPLACEMENT COVERS

ITEM	UOM	CASE
SSTC-12	Each	6/12
SSTC-20	Each	6/12
SSTC-32	Each	6
SSTC-40	Each	6
SSTC-60	Each	6
SSTC-80	Each	6

### SAUTÉ PANS WITH COVER INCLUDED

ITEM	DESCRIPTION	SIZE (DIA X HEIGHT)	UOM	CASE
SSET-3	3 Qt	10" x 2-3/4"	Set	1/6
SSET-5	5 Qt	12-3/8" x 3-1/8"	Set	1/4
SSET-7	7 Qt	14" x 3-1/2"	Set	1/4

### REPLACEMENT COVERS

ITEM	UOM	CASE
SSTC-8	Each	6/12
SSTC-20	Each	6/12
SSTC-24	Each	6

## PREMIUM STAINLESS STEEL DISPLAY PANS



SSOP-8



SSOP-11



SSOP-14

## STAINLESS STEEL DISPLAY PANS

ITEM	DESCRIPTION	SIZE (DIA X H)	UOM	CASE
SSOP-8	8"	8" x 1-3/4"	Each	1/6
SSOP-9	9-1/2"	9-1/2" x 2"	Each	1/6
SSOP-11	11"	11" x 2-1/8"	Each	1/6
SSOP-12	12-1/2"	12-1/2" x 2-1/4"	Each	1/2
SSOP-14	14"	14" x 2-1/4"	Each	1/2



SSOP-SERIES

## PREMIUM STAINLESS STEEL FRY PANS



SSFP-11



SSFP-14



SSFP-11NS



SSFP-14NS

- ◆ Heavy-duty premium 18/8 stainless steel offers excellent corrosion resistance and a bright finish
- ◆ Tri-ply bottom for even heat distribution
- ◆ Extra-sturdy, riveted, 6-point welded handles

## STAINLESS STEEL FRY PANS

- ◆ Induction ready
- ◆ NSF listed

ITEM	DESCRIPTION	SIZE	UOM	CASE
SSFP-8	8"	8" x 1-1/2"	Each	1/6
SSFP-9	9-1/2"	9-1/2" x 1-3/4"	Each	1/6
SSFP-11	11"	11" x 2"	Each	1/6
SSFP-12	12", Help Hdl	12-1/2" x 2"	Each	1/2
SSFP-14	14", Help Hdl	14-1/4" x 2-1/2"	Each	1/2

## NON-STICK FRY PANS

- ◆ Excalibur® non-stick coating
- ◆ Induction ready
- ◆ PTFE/PFOA-free; NSF listed

ITEM	DESCRIPTION	SIZE	UOM	CASE
SSFP-8NS	8"	8" x 1-1/2"	Each	1/6
SSFP-9NS	9-1/2"	9-1/2" x 1-3/4"	Each	1/6
SSFP-11NS	11"	11" x 2"	Each	1/6
SSFP-12NS	12", Help Hdl	12-1/2" x 2"	Each	1/2
SSFP-14NS	14", Help Hdl	14-1/4" x 2-1/2"	Each	2

## COVERS FOR STAINLESS STEEL FRY PANS

ITEM	DESCRIPTION	UOM	CASE
SSTC-8F	Cover for 8" Fry Pans	Each	6/12
SSTC-8	Cover for 9-1/2" Fry Pans	Each	6/12
SSTC-12	Cover for 10" and 11" Fry Pans	Each	6/12
SSTC-12F	Cover for 12" Fry Pans	Each	6/12
SSTC-32	Cover for 14" Fry Pans	Each	6



SSFP-SERIES

NON-STICK FRY PANS



**PREMIUM STAINLESS STEEL 7PC COOKWARE SET**

- ◆ Induction ready
- ◆ Extra heavy-weight 18/8 stainless steel with double riveted handles
- ◆ Aluminum core, best for fast and even distribution of heat, is impact bonded between two layers of stainless steel, ensuring a lifetime of use

ITEM	DESCRIPTION	UOM	CASE
SPC-7H	7-Pc Set	Set	1/2



SPC-7H  

**PREMIUM STAINLESS STEEL 7PC COOKWARE SET**

**Set Includes:**

- ◆ 1 Qt Sauce Pan w/Cover
- ◆ 2 Qt Sauce Pan w/Cover
- ◆ 5 Qt Dutch Oven w/Cover
- ◆ 9-1/2" Sauté Pan

**EGG POACHER SET: STAINLESS STEEL PAN WITH INNER NON-STICK CUPS**

When a meal calls for perfectly poached eggs, this 4-cup set gets the job done quickly. The glass lid provides easy monitoring without the loss of heat so eggs cook uniformly. Also functions as mini double-boiler to melt butter or chocolate, or steam individual custard portions.

- ◆ Suitable for all stove tops, including induction
- ◆ Handles on lid and pan covered with permanent cool-touch material for easier handling
- ◆ Interior of pan, tray and cups feature PTFE/PFOA-free non-stick coating for easy release and cleaning
- ◆ Dishwasher safe



ITEM	DESCRIPTION	UOM	CASE
CEP-4	Pan, Lid & 4-Cup Set	Set	1/6

**EGG POACHER SET**

**Set Includes:**

- ◆ S/S sauce pan
- ◆ Glass cover
- ◆ Inner tray with 4 cups, each with cool-touch handles



CEP-4  

INTERIOR OF PAN, TRAY, & CUPS

**STAINLESS STEEL MIRROR FINISH SAUCE PANS**

- ◆ Triple-riveted handle

ITEM	DESCRIPTION	UOM	CASE
SAP-1.5	1-1/2 Qt	Each	12/36
SAP-2	2 Qt	Each	12/36

**MIRRORED SAUCE PANS**



SAP-2

**DOUBLE POT HOOK**

ITEM	DESCRIPTION	UOM	CASE
PH-2	Pot Hook	Each	24/240

**DOUBLE POT HOOK**



PH-2

# STAINLESS STEEL DOUBLE BOILERS & PERFORATED STEAMERS



## STAINLESS STEEL DOUBLE BOILERS & PERF'D STEAMERS

- ◆ Induction ready
- ◆ 18/8 Stainless steel; tri-ply bottom
- ◆ Cover included

ITEM	DESCRIPTION	SIZE	UOM	CASE
SSDB-8	8 Qt Double Boiler	9-1/2" x 6-3/4" & 7-1/2"	Set	1/6
SSDB-12	12 Qt Double Boiler	10-1/4" x 8-1/2" & 9-3/8"	Set	1/6
SSDB-16	16 Qt Double Boiler	11" x 9-5/8" & 10-1/2"	Set	1/4
SSDB-20	20 Qt Double Boiler	11-7/8" x 10-5/8" & 11-1/2"	Set	1/4
SSDB-8S	8 Qt Steamer/Pasta Cooker	9-1/2" x 6-3/4" & 7-1/2"	Set	1/6
SSDB-12S	12 Qt Steamer/Pasta Cooker	10-1/4" x 8-1/2" & 9-3/8"	Set	1/6
SSDB-16S	16 Qt Steamer/Pasta Cooker	11" x 9-5/8" & 10-1/2"	Set	1/4
SSDB-20S	20 Qt Steamer/Pasta Cooker	11-7/8" x 10-5/8" & 11-1/2"	Set	1/4



SSDB-20

### REPLACEMENT COVERS

ITEM	DESCRIPTION	UOM	CASE
SSTC-8	Replacement Cover for 8 Qt	Each	6/12
SSTC-10	Replacement Cover for 12 Qt	Each	6
SSTC-12	Replacement Cover for 16 Qt	Each	6/12
SSTC-20	Replacement Cover for 20 Qt	Each	6/12



SSDB-20S



SSDB-8 & SSDB-8S

SSDB-12 & SSDB-12S

SSDB-16 & SSDB-16S

SSDB-20 & SSDB-20S



SSDB-SERIES  
SSTC-SERIES





### CARBON STEEL FRENCH-STYLE FRY PANS

The Spanish-made, French-style fry pan is ideal for high-heat cooking. Well suited for long pre-heating and searing. Hand wash for best results.

- ◆ Made in Spain
- ◆ High-quality carbon steel pan allows for long pre-heating at high temperatures; suitable for searing
- ◆ Sturdy, riveted handle
- ◆ **Hand wash**, dry immediately and completely; rub on light coat of cooking oil and store in dry, non-humid area

ITEM	DESCRIPTION	UOM	CASE
CSFP-7	7-7/8"	Each	5
CSFP-8	8-5/8"	Each	8
CSFP-9	9-1/2"	Each	7
CSFP-11	10-3/8"	Each	4
CSFP-12	11-1/8"	Each	3

\*Replaces former FSFP-Series

### CARBON STEEL PANS



CSFP-11

CSFP-SERIES



### CARBON STEEL PAELLA PANS

These Spanish-made carbon steel pans are ideal for the creation and display of authentic paella dishes, roasting meat, making stir-fry, and much more!

- ◆ Made in Spain
- ◆ **Hand wash**, dry thoroughly and store in dry area

ITEM	DESCRIPTION	FINISH	UOM	CASE
CSPP-7	7-7/8"	Polished	Each	12
CSPP-11	11"	Polished	Each	10
CSPP-14	14-1/8"	Polished	Each	5
CSPP-23	23-5/8"	Polished	Each	1
CSPP-35	35-1/2", 4 Hds	Polished	Each	1
CSPP-11E	11"	Enameled	Each	10
CSPP-14E	14-1/8"	Enameled	Each	5
CSPP-23E	23-5/8"	Enameled	Each	1



CSPP-11

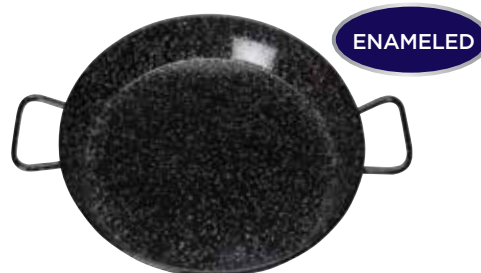

CSPP-14E



CSPP-35

## WOKS & ACCESSORIES



WOK-16W



WOK-16N Joint



WOK-36



WKCS-14



WKR-8

### CHINESE WOKS

- ◆ Stainless steel mirror finish

ITEM	DESCRIPTION	UOM	CASE
WOK-14N	14", Riveted Joint	Each	12
WOK-16N	16", Riveted Joint	Each	12
WOK-14W	14", Welded Hdl	Each	12
WOK-16W	16", Welded Hdl	Each	12

### BLACK CARBON STEEL JAPANESE-STYLE WOKS

- ◆ Integrated handle with welded joint for enhanced strength
- ◆ 1.2 mm thickness

ITEM	DESCRIPTION	UOM	CASE
WOK-34	14"	Each	12
WOK-36	16"	Each	12

### WOK COVERS

- ◆ Stainless steel

ITEM	DESCRIPTION	UOM	CASE
WKCS-14	13-3/4"	Each	12/60
WKCS-15	15-3/8"	Each	12/48
WKCS-18	17-3/4"	Each	12/36

### WOK RING STAND

- ◆ Stainless steel

ITEM	DESCRIPTION	UOM	CASE
WKR-8	8"	Each	12/120

## GRIDDLES



HAG-2012



IGD-2095



Flat griddle side



### DELUXE HARD-ANODIZED ALUMINUM GRIDDLE

- ◆ Great for use on all kinds of ranges
- ◆ Convert open range-top to griddle surface
- ◆ Raised handles are silicone wrapped, preventing heat transfer; provide easy transport

ITEM	DESCRIPTION	UOM	CASE
HAG-2012	19-5/8"L x 12-1/4"W	Each	1/6

### REVERSIBLE CAST IRON GRILL/GRIDDLE

- ◆ Ribbed grill surface on one side, flat griddle on the other
- ◆ Pre-seasoned

ITEM	DESCRIPTION	UOM	CASE
IGD-2095	20"L x 9-1/2"W	Each	4

## FAJITA SERVERS



FS-2



ISP-3

### FAJITA SERVERS

- ◆ Attractive wooden underliner provides protective barrier between tabletop and hot platter; resists splitting or cracking under hot cast iron pan



ITEM	DESCRIPTION	UOM	CASE
FS-2	Fajita Server, 2-pc Set	Set	1/12
FS-2-UL	Replacement Underliner for FS-2	Each	12
ISP-3	Steak Platter with Gripper, 3-Pc Set	Set	1/12
ISP-3-UL	Replacement Underliner for ISP-3	Each	12



## PAN HANDLE SLEEVES



HDH-6C



HDH-7S

### SKILLET/PAN HANDLE SLEEVES

- ◆ Heat-resistant up to 250°F (120°C)

ITEM	DESCRIPTION	SIZE	UOM	CASE
HDH-6C	Chili Peppers Cotton Sleeve	3-1/2" x 6-1/2"	Doz	1/24
HDH-7S	Cotton Sleeve	3-1/2" x 6-1/2"	Doz	1/24



**FIREIRON™ CAST IRON COOKWARE**

Designed to last for generations, FireIron™ cast iron pans are pre-seasoned and induction ready. Great for kitchen-to-table service.

- ◆ Fine, smooth surface for excellent sear; also sauté, fry, boil, braise, bake and roast
- ◆ Wide-grip dual handles with thumbrest for comfortable grip and better handling
- ◆ Induction ready; multiple cooking surfaces compatible

**FIREIRON™ CAST IRON SKILLETS WITH DUAL HANDLES**

ITEM	DESCRIPTION	UOM	CASE
CASD-8	8" Dia	Each	6
CASD-10	10" Dia	Each	4
CASD-12	12" Dia	Each	4

**FIREIRON™ CAST IRON GRILL PANS W/ HELPER HANDLE**

ITEM	DESCRIPTION	UOM	CASE
CAGP-10R	10-1/4" Dia	Each	4
CAGP-10S	10-1/2" Square	Each	4



Wide handles



Thumbrest

**FIREIRON™ CAST IRON SKILLETS**

ITEM	DESCRIPTION	UOM	CASE
CAST-6	6"	Each	6
CAST-8	8"	Each	6
CAST-10	10" with Helper Handle	Each	4
CAST-12	12" with Helper Handle	Each	4

SEE PAGE 82 FOR SINGLE-SERVE MINI CAST IRON

**ROUND CAST IRON GRILL PAN**

ITEM	DESCRIPTION	UOM	CASE
IGL-10	10", Black Coating	Each	8

**CAST IRON COOKWARE**



**NEW**  
CASD-12

CASD-SERIES



**NEW**  
CAGP-10R



**NEW**  
CAGP-10S

CAGP-SERIES



CAST-6  
CAST-8  
CAST-10  
CAST-12  
CAST-SERIES



IGL-10

# ALUMINUM COOKWARE



Fry Pans | Sauce Pots | Braziers | Stock Pots | Sauté Pans

**INDUCTION  
READY**



**PFOA  
FREE**



pg 212

**GLADIATOR™**

with



Non-stick

**PFOA  
FREE**



pg 213



Excellent quality for the price

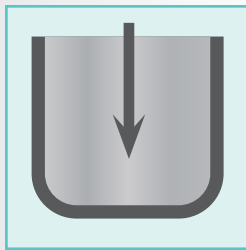

Deep-drawn structure for better strength and durability



Ergonomic handles for comfort



3003 aluminum for fast and even heat distribution with no hot spots

## SUPER ALUMINUM

6.0 mm,  
1/4" thickness

4.0 mm,  
3/16" thickness

pg 214-216



## MAJESTIC™

with



Non-stick

PFOA  
FREE

pg 213



## INDUCTION READY ALUMINUM COOKWARE



Induction ready pot/pan base



AFPI-10H



AFPI-SERIES



NON-STICK FRY PANS



New hybrid technology bonds a stainless steel plate to aluminum cookware, as effective in utilizing induction technology as full stainless steel cookware.

- ◆ Deep drawn 3003 Aluminum body is durable and highly conductive, better than stainless steel cookware for quickly and evenly distributing heat
- ◆ Stainless steel bonded plate allows for magnetic contact with induction cooktops
- ◆ Thicker handles and heavier rivets than standard cookware allow for secure comfort in transporting cookware
- ◆ Can also be safely used with gas or electric ranges
- ◆ NSF listed

### NATURAL FINISH INDUCTION READY ALUMINUM FRY PANS

- ◆ Ergonomic comfort handle is heat resistant to 500°F (260°C)

ITEM	DESCRIPTION	PLATE SIZE	UOM	CASE
AFPI-8H*	8"Dia	5"	Each	6
AFPI-10H	10"Dia	6-1/4"	Each	6
AFPI-12H	12"Dia	6-7/8"	Each	6

\*Compatible with all Winco® induction cookers. (May not be compatible with all induction cookers on the market.)

### NON-STICK INDUCTION READY ALUMINUM FRY PANS

- ◆ Quantum2® non-stick finish bonds to the aluminum for long-lasting, scratch-resistance
- ◆ Ergonomic comfort handle is heat resistant to 500°F (260°C)
- ◆ PTFE/PFOA-free

ITEM	DESCRIPTION	PLATE SIZE	UOM	CASE
AFPI-8NH*	8"Dia	5"	Each	6
AFPI-10NH	10"Dia	6-1/4"	Each	6
AFPI-12NH	12"Dia	6-7/8"	Each	6

\*Compatible with all Winco® induction cookers. (May not be compatible with all induction cookers on the market.)

### INDUCTION READY STOCK POTS

- ◆ Reinforced rim adds extra durability, extending the integrity of the cookware
- ◆ 3003 Aluminum, 4.0mm, 3/16" thick
- ◆ 10" diameter opening

ITEM	DESCRIPTION	HEIGHT	PLATE SIZE	UOM	CASE
AXSI-8	8 Qt	6-1/2"H	7-1/2"	Each	1
AXSI-10	10 Qt	7-1/2"H	7-1/2"	Each	1
AXSI-12	12 Qt	9"H	7-1/2"	Each	1
AXSI-16	16 Qt	12"H	7-1/2"	Each	1

### INDUCTION READY SAUTÉ PAN

- ◆ Thicker handle and heavier rivets than standard cookware allow for secure comfort when lifting and carrying
- ◆ 3003 Aluminum, 4.0mm, 3/16" thick

ITEM	DESCRIPTION	PLATE SIZE	UOM	CASE
AXTI-3	3 Qt	7-1/2"	Each	6

SEE PAGE 392 FOR INDUCTION COOKTOPS



AXSI-16



AXSI-SERIES



AXTI-3



## COVERS FOR ALUMINUM FRY PANS



AXS-20C



AXS-SERIES

## COVERS FOR ALUMINUM FRY PANS

ITEM	DESCRIPTION	UOM	CASE
ASP-2C	For 8" Fry Pan	Each	12
AXS-16C	For 10" Fry Pan	Each	6
AXS-20C	For 12" Fry Pan	Each	6
AXS-40C	For 14" Fry Pan	Each	6

Constructed of 3003 series aluminum alloy with riveted heavy weight handles, the Gladiator fry pans will keep up with the rigorous demands of a commercial kitchen, in addition to providing excellent heat distribution for searing, browning and frying.

- ◆ 3.5mm thickness
- ◆ NSF listed

### GLADIATOR™ NATURAL FINISH

ITEM	DESCRIPTION	UOM	CASE
AFP-7A	7"Dia	Each	6
AFP-8A	8"Dia	Each	6
AFP-10A	10"Dia	Each	6
AFP-12A	12"Dia	Each	6
AFP-14A	14"Dia	Each	6
AFP-7A-H	7"Dia with Sleeve	Each	6
AFP-8A-H	8"Dia with Sleeve	Each	6
AFP-10A-H	10"Dia with Sleeve	Each	6
AFP-12A-H	12"Dia with Sleeve	Each	6
AFP-14A-H	14"Dia with Sleeve	Each	6

### GLADIATOR™ EXCALIBUR® NON-STICK

- ◆ Excalibur® non-stick finish bonds to the aluminum for a long lasting, scratch-resistant finish

ITEM	DESCRIPTION	UOM	CASE
AFP-7XC	7"Dia	Each	6
AFP-8XC	8"Dia	Each	6
AFP-10XC	10"Dia	Each	6
AFP-12XC	12"Dia	Each	6
AFP-14XC	14"Dia	Each	6
AFP-7XC-H	7"Dia with Sleeve	Each	6
AFP-8XC-H	8"Dia with Sleeve	Each	6
AFP-10XC-H	10"Dia with Sleeve	Each	6
AFP-12XC-H	12"Dia with Sleeve	Each	6
AFP-14XC-H	14"Dia with Sleeve	Each	6

- ◆ Made of 3003 aluminum alloy, the Majestic™ fry pans offer exceptional performance at a great value
- ◆ Available in three finishes: Majestic™ mirror, Majestic™ natural & Majestic™ Quantum2® non-stick
- ◆ 3.5mm thickness
- ◆ NSF listed

### MAJESTIC™ NATURAL FINISH

ITEM	DESCRIPTION	UOM	CASE
AFP-7S	7"Dia	Each	6
AFP-8S	8"Dia	Each	6
AFP-10S	10"Dia	Each	6
AFP-12S	12"Dia	Each	6
AFP-14S	14"Dia	Each	6

### MAJESTIC™ MIRROR FINISH

ITEM	DESCRIPTION	UOM	CASE
AFP-7	7"Dia	Each	6
AFP-8	8"Dia	Each	6
AFP-10	10"Dia	Each	6
AFP-12	12"Dia	Each	6
AFP-14	14"Dia	Each	6

### MAJESTIC™ QUANTUM2® NON-STICK

ITEM	DESCRIPTION	UOM	CASE
AFP-7NS	7"Dia	Each	6
AFP-8NS	8"Dia	Each	6
AFP-10NS	10"Dia	Each	6
AFP-12NS	12"Dia	Each	6
AFP-14NS	14"Dia	Each	6
AFP-7NS-H	7"Dia with Sleeve	Each	6
AFP-8NS-H	8"Dia with Sleeve	Each	6
AFP-10NS-H	10"Dia with Sleeve	Each	6
AFP-12NS-H	12"Dia with Sleeve	Each	6
AFP-14NS-H	14"Dia with Sleeve	Each	6

## GLADIATOR™ FRY PANS



AFP-10A

AFP-10A-H



AFP-10XC

AFP-10XC-H



## MAJESTIC™ FRY PANS



AFP-8S

AFP-10

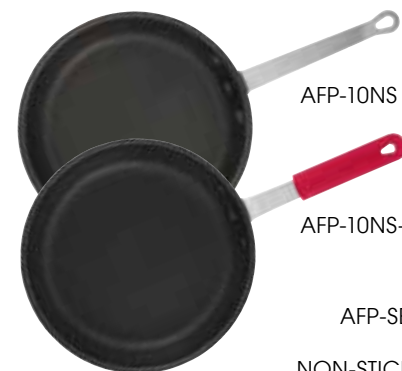

AFP-10NS

AFP-10NS-H



SEE PAGE 216 FOR 140QT & 160QT



AXHB-28



AXHA-60



AXHH-40

**SUPER ALUMINUM EXTRA-HEAVYWEIGHT COOKWARE**

**6.0 mm, 1/4" thickness**

- ◆ Extra-durable 6mm thick aluminum core ensures long-lasting performance through washing & constant heating
- ◆ 3003 Aluminum for superior heat distribution
- ◆ Riveted handles designed for strength & durability
- ◆ Wide base & deep-drawn high walls allow for recipe versatility



Sturdy Handles

**EXTRA HEAVYWEIGHT ALUMINUM STOCK POTS**

ITEM	DESCRIPTION	SIZE (DIA X HEIGHT)	UOM	CASE
AXHH-12	12 Qt	10" x 9-1/4"	Each	1
AXHH-16	16 Qt	10" x 12"	Each	1
AXHH-20	20 Qt	12" x 10-1/2"	Each	1
AXHH-24	24 Qt	12" x 12-1/2"	Each	1
AXHH-32	32 Qt	13" x 14"	Each	1
AXHH-40	40 Qt	14" x 15"	Each	1
AXHH-60	60 Qt	16" x 17"	Each	1
AXHH-80	80 Qt	18" x 18-1/4"	Each	1
AXHH-100*	100 Qt	20" x 19"	Each	1
AXHH-120*	120 Qt	20" x 23"	Each	1
AXHH-120H*	120 Qt, 4 Hdls	20" x 23"	Each	1

\*Replaces ALHP-Series

**COVERS**

ITEM	UOM	CASE
AXS-16C	Each	6
AXS-16C	Each	6
AXS-20C	Each	6
AXS-20C	Each	6
AXS-32C	Each	6
AXS-40C	Each	6
AXS-60C	Each	6
AXS-80C	Each	6
AXS-100C	Each	6
AXS-100C	Each	6
AXS-100C	Each	6

**EXTRA HEAVYWEIGHT ALUMINUM SAUCE POTS**

ITEM	DESCRIPTION	SIZE (DIA X HEIGHT)	UOM	CASE
AXHA-8	8 Qt	10" x 6-1/8"	Each	1
AXHA-14	14 Qt	12" x 7-3/4"	Each	1
AXHA-20	20 Qt	13" x 9-1/4"	Each	1
AXHA-26	26 Qt	14" x 10-1/4"	Each	1
AXHA-34	34 Qt	16" x 10-1/4"	Each	1
AXHA-40	40 Qt	16" x 11-3/4"	Each	1
AXHA-60	60 Qt	18" x 13-3/4"	Each	1

**COVERS**

ITEM	UOM	CASE
AXS-16C	Each	6
AXS-20C	Each	6
AXS-32C	Each	6
AXS-40C	Each	6
AXS-60C	Each	6
AXS-60C	Each	6
AXS-80C	Each	6

**EXTRA HEAVYWEIGHT ALUMINUM BRAZIER**

ITEM	DESCRIPTION	SIZE (DIA X HEIGHT)	UOM	CASE
AXHB-15	15 Qt	14" x 5-7/8"	Each	1
AXHB-18	18 Qt	16" x 5-13/32"	Each	1
AXHB-24	24 Qt	18" x 5-5/8"	Each	1
AXHB-28	28 Qt	18" x 6-7/16"	Each	1
AXHB-35	35 Qt	20" x 7"	Each	1
AXHB-40	40 Qt	20" x 8"	Each	1

**COVERS**

ITEM	UOM	CASE
AXS-40C	Each	6
AXS-60C	Each	6
AXS-80C	Each	6
AXS-80C	Each	6
AXS-100C	Each	6
AXS-100C	Each	6





SUPER ALUMINUM COOKWARE



AXS-50



AXBZ-15



AXAP-20



AXST-5

SEE PAGE 216 FOR SAUTÉ PAN HANDLE SLEEVES



Sturdy Handles

**SUPER ALUMINUM HEAVYWEIGHT COOKWARE**

**4.0 mm, 3/16" thickness**

- ◆ Durable 4mm thick aluminum core ensures long-lasting performance with constant heating
- ◆ 3003 Aluminum for superior heat distribution
- ◆ Riveted handles designed for strength & durability
- ◆ Wide base & deep-drawn high walls allow for recipe versatility

**HEAVYWEIGHT ALUMINUM STOCK POTS**

ITEM	DESCRIPTION	SIZE (DIA X HEIGHT)	UOM	CASE
AXS-8	8.5 Qt	10" x 6-1/2"	Each	1
AXS-10	10 Qt	10" x 7-1/2"	Each	1
AXS-12	12 Qt	10" x 9"	Each	1
AXS-16	16 Qt	10" x 12"	Each	1
AXS-20	20 Qt	12" x 10-1/2"	Each	1
AXS-24	24 Qt	12" x 12-1/4"	Each	1
AXS-32	32 Qt	13" x 14"	Each	1
AXS-40	40 Qt	14" x 15"	Each	1
AXS-50	50 Qt	16" x 14"	Each	1
AXS-60	60 Qt	16" x 17"	Each	1
AXS-80	80 Qt	18" x 18-1/4"	Each	1
AXS-100	100 Qt	20" x 19"	Each	1

**COVERS**

ITEM	UOM	CASE
AXS-16C	Each	6
AXS-16C	Each	6
AXS-16C	Each	6
AXS-16C	Each	6
AXS-20C	Each	6
AXS-20C	Each	6
AXS-20C	Each	6
AXS-32C	Each	6
AXS-32C	Each	6
AXS-40C	Each	6
AXS-40C	Each	6
AXS-60C	Each	6
AXS-60C	Each	6
AXS-80C	Each	6
AXS-80C	Each	6
AXS-100C	Each	6

**HEAVYWEIGHT ALUMINUM SAUCE POTS**

ITEM	DESCRIPTION	SIZE (DIA X HEIGHT)	UOM	CASE
AXAP-8	8 Qt	10" x 6"	Each	1
AXAP-14	14 Qt	12" x 7-1/2"	Each	1
AXAP-20	20 Qt	13" x 9"	Each	1
AXAP-26	26 Qt	14" x 10"	Each	1
AXAP-34	34 Qt	16" x 10"	Each	1
AXAP-40	40 Qt	16" x 11-1/2"	Each	1

**COVERS**

ITEM	UOM	CASE
AXS-16C	Each	6
AXS-20C	Each	6
AXS-32C	Each	6
AXS-40C	Each	6
AXS-60C	Each	6
AXS-60C	Each	6

**HEAVYWEIGHT ALUMINUM BRAZIER**

ITEM	DESCRIPTION	SIZE (DIA X HEIGHT)	UOM	CASE
AXBZ-15	15 Qt	14-3/8" x 5-3/4"	Each	1
AXBZ-18	18 Qt	16-3/8" x 5-1/2"	Each	1
AXBZ-24	24 Qt	18-3/8" x 5-3/4"	Each	1
AXBZ-28	28 Qt	18-3/8" x 6-1/2"	Each	1
AXBZ-35	35 Qt	20" x 6-3/4"	Each	1
AXBZ-40	40 Qt	20" x 7-3/4"	Each	1

**COVERS**

ITEM	UOM	CASE
AXS-40C	Each	6
AXS-60C	Each	6
AXS-80C	Each	6
AXS-80C	Each	6
AXS-100C	Each	6
AXS-100C	Each	6

**HEAVYWEIGHT ALUMINUM SAUTÉ PANS (NON-NSF)**

ITEM	DESCRIPTION	SIZE	UOM	CASE
AXST-3	3 Qt	10" x 2-1/2"	Each	6
AXST-5	5 Qt	12-1/2" x 2-1/2"	Each	6
AXST-7	7-1/2 Qt	14-1/2" x 2-3/4"	Each	6

**COVERS**

ITEM	UOM	CASE
AXS-16C	Each	6
AXS-20C	Each	6
AXS-40C	Each	6



**EXTRA-HEAVYWEIGHT ALUMINUM COOKWARE**

**6.0 mm, 1/4" thickness**

- ◆ Durable, long-lasting performance
- ◆ Wide base & deep-drawn high walls for recipe versatility



ALHP-140



ALHP-140H

**EXTRA HEAVYWEIGHT ALUMINUM STOCK POTS**

ITEM	DESCRIPTION	SIZE (DIA X HEIGHT)	UOM	CASE
ALHP-140	140 Qt	22-7/8" x 20-3/8"	Each	1
ALHP-160	160 Qt	22-7/8" x 23-1/4"	Each	1
ALHP-140H	140 Qt, 4 Hdls	22-7/8" x 20-3/8"	Each	1
ALHP-160H	160 Qt, 4 Hdls	22-7/8" x 23-1/4"	Each	1

**NSF. PRECISION ALUMINUM COOKWARE**



ALPC-140

**ALUMINUM COVER**

ITEM	DESCRIPTION	UOM	CASE
ALPC-140	Fits ALHP-140/140H/160/160H	Each	6

**COOKWARE ACCESSORIES**

**PAN GRABBER**

- ◆ Heat-resistant up to 400°F (205°C)



PH-811W

SEE PAGE 261 FOR OVEN MITTS

ITEM	DESCRIPTION	SIZE (L X W)	UOM	CASE
PH-811W	Terry Cloth	11" x 8"	Doz	15

**REMOVABLE SILICONE SLEEVES FOR FRY & SAUCE PANS**

- ◆ Heat-resistant up to 450°F (230°C)



AFP-1HR



AFP-1HX



AFP-2HR



AFP-2HX



AFP-3HR



AFP-3HX

ITEM	DESCRIPTION	COLOR	UOM	CASE
AFP-1HR	Fits AFP-7, -8, ASP-1, -2	Red	Each	12/120
AFP-2HR	Fits AFP-10, -12, ASP-3, -4, -5, -7, ASFP-11, AXST-3	Red	Each	12/120
AFP-3HR	Fits AFP-14, ASP-10, AXST-5, -7	Red	Each	12/120
AFP-1HX	Fits AFP-7, -8, ASP-1, -2	Blue	Each	12/120
AFP-2HX	Fits AFP-10, -12, ASP-3, -4, -5, -7, ASFP-11, AXST-3	Blue	Each	12/120
AFP-3HX	Fits AFP-14, ASP-10, AXST-5, -7	Blue	Each	12/120

SEE PAGE 295 FOR MORE OF THE ALLERGEN-FREE LINE



AFP-10HP

**ALLERGEN-FREE SILICONE SLEEVE**

ITEM	DESCRIPTION	COLOR	UOM	CASE
AFP-10HP	Fits AFP-10, ASFP-11, ASP-3, -4	Purple	Each	1/120

### DOUBLE ROASTER COMBINATION

◆ Heavy-duty 10 gauge aluminum

ITEM	DESCRIPTION	SIZE	UOM	CASE
ALRP-1824	Roaster with Straps	24"L x 18"W x 4-1/2"H	Each	2
ALRP-1824L	Roaster with Straps & Lugs	24"L x 18"W x 4-1/2"H	Each	2

### ALUMINUM ROASTING PANS



ALRP-1824



ALRP-1824L

REINFORCED,  
IMPROVED  
FINISH

### BAKE/ROAST PANS

◆ Heavy-duty 12 gauge aluminum

ITEM	DESCRIPTION	SIZE	UOM	CASE
ALRP-1826	Pan without Handles	25-3/4"L x 17-3/4"W x 2-1/4"H	Each	3
ALRP-1826H	Pan with Handles	25-3/4"L x 17-3/4"W x 3-1/2"H	Each	3



ALRP-1826H



ALRP-1826

### BAKE/ROAST PAN

◆ Aluminum

ITEM	DESCRIPTION	SIZE	UOM	CASE
ALBP-1218	Pan with Handles	17-3/4"L x 11-1/2"W x 2-1/4"H	Each	6/24



ALBP-1218

### HEAVY-DUTY ALUMINUM SHEET PANS

Reinforced with galvanized wire, count on Winco® sheet pans to hold their shape in high-heat oven temperatures during baking, roasting or broiling.

- ◆ Closed bead with galvanized wire for rust resistance and reinforcement
- ◆ Made of 3003 aluminum

ITEM	DESCRIPTION	SIZE	GAUGE	UOM	CASE
ALXP-1200	Full-Size Open Bead, NSF	18" x 26"	12	Each	12
ALXP-2618H	Full-Size Closed Bead	18" x 26"	16	Each	12



Open bead



ALXP-1200



SEE PAGE 238  
FOR MORE  
SHEET PANS



## ALUMINUM GYRO PAN



Curved front



**NSF** AGP-10

## 10" ALUMINUM GYRO PAN

The perfect pan for catching meat that is carved off of a gyro cone when rotating on a vertical broiler.

- ◆ Ergonomically designed, insulated silicone handle is heat-resistant up to 450°F (230°C)
- ◆ NSF listed

ITEM	DESCRIPTION	UOM	CASE
AGP-10	10" Gyro Pan	Each	12

## HEAVY-DUTY STRAIGHT ALUMINUM SAUCE PANS



ASP-6SW

**NSF** ASP-SERIES

## ALUMINUM STRAIGHT-SIDED SAUCE PANS

- ◆ 3003 Aluminum, 4.0mm thickness
- ◆ Broad base offers widest area for optimal heating; ideal for cooking sauces or vegetables

ITEM	DESCRIPTION	SIZE (DIA X H)	UOM	CASE
ASP-2SW	2-1/2 Qt	7-1/2" x 3-5/16"	Each	12
ASP-4SW	4 Qt	7-1/2" x 5-1/4"	Each	6
ASP-6SW	6-1/2 Qt	10" x 5"	Each	6
ASP-8SW	8-1/2 Qt	10" x 6-1/2"	Each	6

### COVERS

ITEM	DESCRIPTION	UOM	CASE
ASP-2C	Cover for 2-1/2 Qt & 4 Qt	Each	12
ASP-5C	Cover for 6-1/2 Qt & 8-1/2 Qt	Each	12

## HEAVY-DUTY TAPERED ALUMINUM SAUCE PANS



ASP-5

ASP-5C

**NSF** ASP-SERIES

## ALUMINUM TAPERED SAUCE PANS

- ◆ 3003 Aluminum, 3.0mm thickness
- ◆ Flared sides for easier stirring and churning

ITEM	DESCRIPTION	SIZE (DIA X H)	UOM	CASE
ASP-1	1-1/2 Qt	5-3/4" x 3-5/8"	Each	12
ASP-2	2-1/2 Qt	7-3/4" x 4-1/8"	Each	12
ASP-3	3-3/4 Qt	9" x 4-1/4"	Each	12
ASP-4	4-1/4 Qt	9" x 4-5/8"	Each	12
ASP-5	5 Qt	9-3/4" x 5-1/8"	Each	12
ASP-7	7 Qt, Help Hdl	10-1/2" x 5-1/4"	Each	6
ASP-10	10 Qt, Help Hdl	11-1/2" x 5-3/4"	Each	6

### COVERS

ITEM	DESCRIPTION	UOM	CASE
ASP-1C	Cover for 1-1/2 Qt	Each	12
ASP-2C	Cover for 2-1/2 Qt	Each	12
ASP-3C	Cover for 3-3/4 Qt	Each	12
ASP-4C	Cover for 4-1/4 Qt	Each	12
ASP-5C	Cover for 5 Qt	Each	12
ASP-7C	Cover for 7 Qt	Each	12
ASP-10C	Cover for 10 Qt	Each	12

**ALUMINUM STIR FRY PANS**

- ◆ 3003 Aluminum, 4.0mm thickness
- ◆ Ergonomic, heat-resistant silicone handle
- ◆ NSF listed

ITEM	DESCRIPTION	SIZE (DIA X H)	UOM	CASE
ASFP-11	Natural Finish	11" x 3-5/8"	Each	6
ASFP-11NS	Non-stick, Quantum2® Coating	11" x 3-5/8"	Each	6



**ALUMINUM STIR FRY PANS**



ASFP-11



ASFP-11NS

ASFP-SERIES **NSF**

ASFP-11NS **PFOA FREE**

**PASTA COOKER SET**

- ◆ Heavyweight 3003 aluminum pot, 3.5mm
- ◆ Includes 4 stainless steel inserts, 0.7mm thick
- ◆ Handles are heat-resistant up to 500°F (260°C)

ITEM	DESCRIPTION	UOM	CASE
APS-20	20 Qt Pasta Cooker Set	Set	1
APS-INS	Quarter-Size S/S Inset	Each	4
APS-PT	Replacement Pot	Each	1

**PASTA COOKER SET**



APS-20

**ALUMINUM STEAMER BASKETS**

ITEM	DESCRIPTION	UOM	CASE
ALSB-20	20 Qt Fits ALST-20, ALHP-20, AXHH-20, & AXS-20	Each	1
ALSB-32	32 Qt Fits ALST-32, ALHP-32, AXHH-32, & AXS-32	Each	1
ALSB-40	40 Qt Fits ALST-40, ALHP-40, AXHH-40, & AXS-40	Each	1
ALSB-60	60 Qt Fits ALST-60, ALHP-60, AXHH-60, & AXS-60	Each	1
ALSB-80	80 Qt Fits ALST-80, ALHP-80, AXHH-80, & AXS-80	Each	1

**ALUMINUM STEAMER BASKETS**



ALSB-32

**POT SCRUBBING BRUSHES**

- ◆ Plastic handle with nylon bristles

ITEM	DESCRIPTION	UOM	CASE
BRN-8P	8"	Each	12/72
BRN-20P	20"	Each	12/72

**POT SCRUBBING BRUSHES**



BRN-20P



BRN-8P

**POT BRUSHES**

- ◆ Wooden handle with coir bristles

ITEM	DESCRIPTION	UOM	CASE
BRP-10	10"	Each	12/72
BRP-20	20"	Each	6/48



BRP-20



BRP-10

# FRY BASKET STRUCTURE

NICKEL PLATED  
NON-WELDED, ONE-PIECE  
CONSTRUCTION

Corners reinforced  
with heavy-gauge wire

One piece from handle to hook



Heavy-gauge wire  
handle with high-  
temperature resistant  
colored plastic coating

# FRY BASKETS DIMENSIONS

CHIMICHANGA/BURRITO  
FRY BASKET

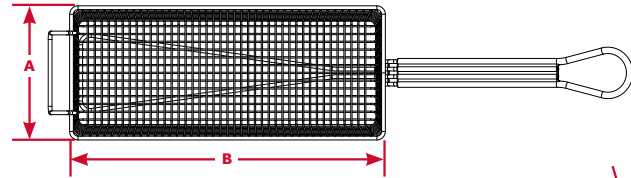
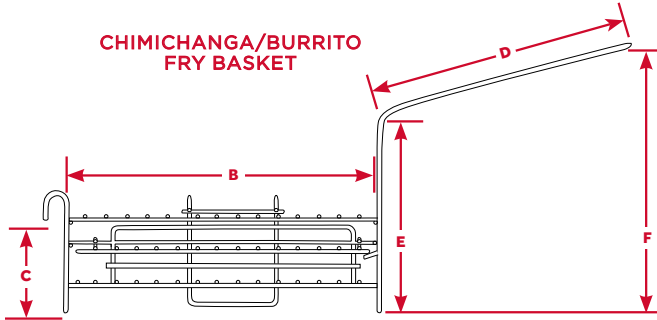

STANDARD  
FRY BASKET

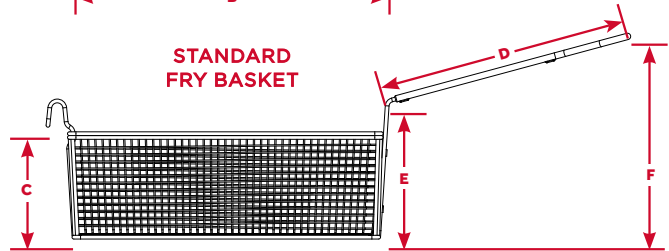

MODEL NO.	PRODUCT NAME	DIMENSIONS (IN.)					
		Length B	Width A	Height C	Handle D	Handle E	Handle F
FB-03	Chimichanga/Burrito Fry Basket	11-1/2	6	3-7/8 (4-5/8 with hook)	8	8-1/4	12
FB-05	Fry Basket	11	5-3/8	4-1/4	10-1/2	6-1/4	8-1/2
FB-10	Fry Basket	12-1/4	6-1/2	5-1/4	10-1/2	9-1/4	11-1/2
FB-20	Fry Basket	13-1/4	5-3/4	5-5/8	10-1/2	9-1/4	10-3/4
FB-25	Fry Basket	12-7/8	6-5/8	5-1/4	10-1/2	9	10-1/8
FB-30	Fry Basket	13-1/4	6-1/2	6	10-1/2	9	11
FB-35	Fry Basket	13-3/8	9-1/2	6-1/8	10-1/2	9-1/4	11-1/4
FB-40	Fry Basket	17	8-3/8	6	12	8	10-7/8

## FRY BASKET ACCESSORIES



### FRY BASKET DIVIDER

- ◆ Removable handles for easy cleaning
- ◆ Divide a fryer basket into multiple compartments for small-batch, portioned frying
- ◆ Fits Winco® fry basket models FB-10, FB-25, FB-30 (6-1/2"W)

ITEM	DESCRIPTION	UOM	CASE
FB-DIV	Fry Basket Divider	Each	12/72



Divide fry baskets for  
smaller batches  
Shown with FB-25



FB-DIV

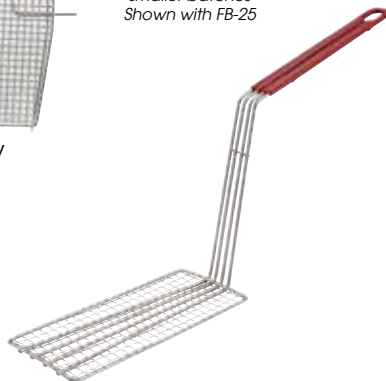

FB-PB

### FRY BASKET PRESSES

- ◆ Heavy gauge wire handles with high-temperature resistant colored plastic coating
- ◆ Nickel plated

ITEM	DESCRIPTION	COLOR	UOM	CASE
FB-PS	Press Fits FB-10 & FB-20, 11" Handle	Red	Each	20
FB-PB	Press Fits FB-30, 11" Handle	Red	Each	20

## FRY BASKETS

- ◆ One-piece construction, non-welded structure
- ◆ Reinforced, strong, long-lasting frame
- ◆ Heavy gauge wire handles with high-temperature resistant colored plastic coating
- ◆ Nickel plated

ITEM	DESCRIPTION	COLOR	UOM	CASE
FB-05	11" x 5-3/8" x 4-1/4", 10-1/2" Handle	Black	Each	6
FB-10	12-1/4" x 6-1/2" x 5-1/4", 10-1/2" Handle	Orange	Each	6
FB-20	13-1/4" x 5-3/4" x 5-5/8", 10-1/2" Handle	Blue	Each	6
FB-25	12-7/8" x 6-5/8" x 5-1/4", 10-1/2" Handle	Red	Each	6
FB-30	13-1/4" x 6-1/2" x 6", 10-1/2" Handle	Green	Each	6
FB-35	13-3/8" x 9-1/2" x 6-1/8", 10-1/2" Handle	Grey	Each	6
FB-40	17" x 8-3/8" x 6", 12" Handle	Yellow	Each	6



Packaging lists the models each FB item fits

## FRY BASKETS

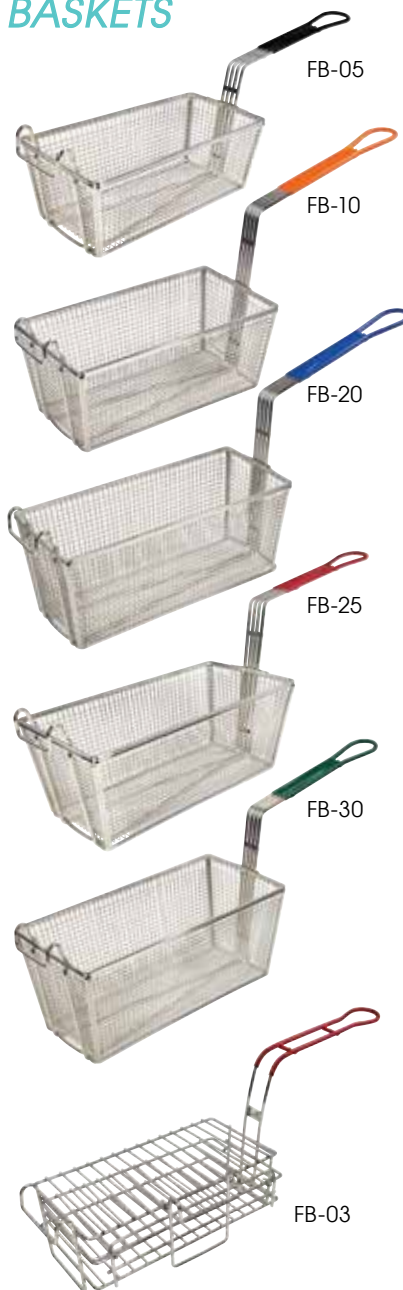

VIEW FRY BASKET FIT GUIDE ONLINE AT [WWW.WINCOUS.COM](http://WWW.WINCOUS.COM)



## CHIMICHANGA/BURRITO FRY BASKET

- ◆ Heavy gauge wire handle coated with high-temperature resistant colored plastic
- ◆ Commercial quality 18/8 stainless steel
- ◆ Two hinged wire shelves; front and side hooks

ITEM	DESCRIPTION	UOM	CASE
FB-03	11-1/2" x 6" x 3-7/8" w/o hook, 8" Handle	Each	6



## CHROME-PLATED TORTILLA SHELL FRY BASKET

- ◆ Place tortilla on surface of oil in fryer, then push tortilla into the oil with fry basket

ITEM	DESCRIPTION	UOM	CASE
TB-25	25" Long Handle, 6-1/4" Dia Basket	Each	8

## NICKLE PLATED TACO & TOSTADA BASKETS

ITEM	DESCRIPTION	UOM	CASE
TB-22	18" Hdl, Triangle Basket	Each	12
TB-20	18" Hdl, Round Basket	Each	12
TB-18	Tostada Basket, Eighteen 6" Tostada Shells	Each	8
TB-8	Taco Basket, Eight 6" Taco Shells	Each	8



## FRYER ACCESSORIES



FFBN-1R



FFBN-2

**NSF** FFBN-SERIES



FFB-1R



FFB-2



FF-10 & FF-RC

## FRYER SPLASH GUARD



SFSG-2018

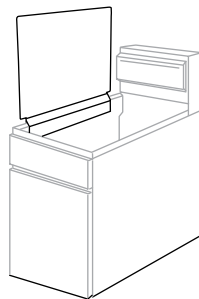

Use on either left or right of fryer

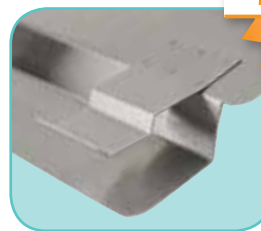

Clips fit 1" wide walls

**18/8**  
**Fits 1" Wall**  
**Stainless Steel**

## WINCO PRIME™ STAINLESS STEEL FRENCH FRY BAGGERS

- ◆ Removable handles for easy cleaning
- ◆ NSF listed

ITEM	DESCRIPTION	UOM	CASE
FFBN-1R	Right Handle, NSF	Each	12/36
FFBN-2	Dual Handles, NSF	Each	12/36

## FRENCH FRY BAGGERS

ITEM	DESCRIPTION	UOM	CASE
FFB-1R	Right Handle	Each	12/36
FFB-2	Dual Handles	Each	12/36

## FRYER FILTER STAND & FILTER

- ◆ Cloth filters are heat resistant up to 392°F (200°C)

ITEM	DESCRIPTION	UOM	CASE
FF-10	10" Fryer Filter Stand	Each	20
FF-RC	Rayon Cloth Filter Cones (10-Pcs/ Box)	Box	1/60



## 18 GAUGE, 18/8 STAINLESS STEEL FRYER SPLASH GUARD

- ◆ 20-1/2"L x 18"H
- ◆ Clips fit most fryers with 1 inch wide walls
- ◆ Use on either left or right side of fryer to prevent oil splashes on walls, floors or other equipment
- ◆ Easily detaches for cleaning

ITEM	DESCRIPTION	UOM	CASE
SFSG-2018	20-1/2"L x 18"H	Each	1/6

## FRYER SCREEN

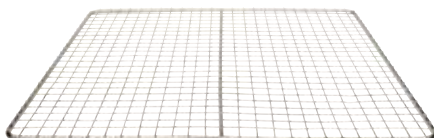

FS-1313

## FRYER SCREEN

- ◆ For use with: Imperial: IFS-40; DCS: FRFG-40; American Range: AF-45; PITCO: 35C and 45C
- ◆ Chrome-plated

ITEM	DESCRIPTION	UOM	CASE
FS-1313	13" x 13"	Each	12/48



The Connoisseur extra-heavyweight premium pasta baskets stand up to constantly knocking the edges when removing pasta. Water flows freely through the cylindrical design for even cooking. Hang-dry with the open-end handles. Most pasta cooker machines and standard stock pots will accommodate these baskets.

**PASTA BASKETS**  
Connoisseur Premium Cookware

**SUPER FINE MESH PASTA BASKETS**

- ◆ Electro-plated 18/8 stainless steel for corrosion resistance; reinforced frame
- ◆ Designed specifically for fine pasta, such as capellini and linguine

ITEM	DESCRIPTION	UOM	CASE
MPF-57	5"Dia x 7"H, Short	Each	1/8
MPF-59	5"Dia x 9"H, Tall	Each	1/8
MPF-67	6-1/2"Dia x 7"H, Wide	Each	1/8

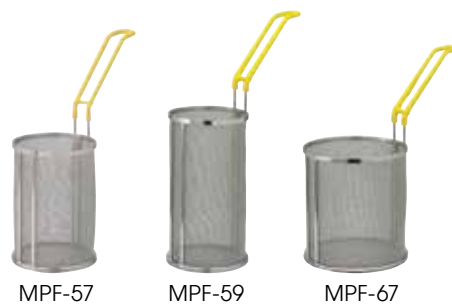

**PASTA BOIL BASKETS**

- ◆ 18/8 stainless steel frame and normal mesh makes it ideal for cooking capellini
- ◆ Fits standard pasta cookers and stock pots

ITEM	DESCRIPTION	UOM	CASE
MPN-57	5-1/4" Dia x 7"H, Short	Each	2/8
MPN-59	5" Dia x 9"H, Tall	Each	2/8
MPN-67	6-1/2" Dia x 7"H, Wide	Each	2/6

**PASTA BOIL BASKETS**

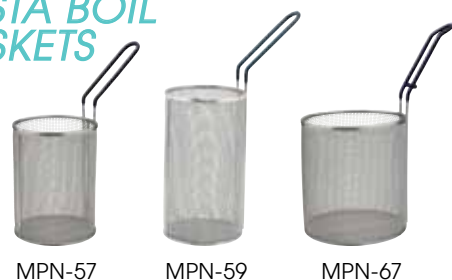

**BULK PASTA/IMMERSION BASKET**

- ◆ Durable 18/8 stainless steel
- ◆ Plastic coated handles rated for temperatures up to 250°F (120°C)
- ◆ Suitable for cooking most types of pasta in bulk
- ◆ Fits standard cookers

ITEM	DESCRIPTION	UOM	CASE
MPN-1613	16-1/4"L x 12-7/8"W x 10"H	Each	2

**BULK PASTA BASKET**



**FRYER PANS**

- ◆ Aluminum hook-on fry pan keeps fry basket secure

ITEM	DESCRIPTION	SIZE	UOM	CASE
ALSP-5	5.5 Qt	10"Dia x 5"H	Each	6
ALSP-7	7 Qt	10-7/8"Dia x 5-3/4"H	Each	6
ALSP-10	10 Qt	12"Dia x 6-1/4"H	Each	6

**FRYER/PASTA COMBINATION PANS**

**ROUND 6 MESH WIRE FRY BASKETS**

- ◆ Nickel plated 1/8" mesh

ITEM	DESCRIPTION	HANDLE	UOM	CASE
FBRS-8	8-11/16"Dia x 4-15/16"H	7-1/4"	Each	20
FBRS-9	9-5/8"Dia x 4-15/16"H	7-1/4"	Each	20
FBRS-11	10-7/16"Dia x 5-5/16"H	9"	Each	20



**ROUND 4 MESH WIRE FRY BASKETS**

- ◆ Nickel plated 1/4" mesh

ITEM	DESCRIPTION	HANDLE	UOM	CASE
FBR-8	8-1/2"Dia x 4-1/4"H	7-1/2"	Each	20
FBR-9	9-1/2"Dia x 5-3/4"H	8"	Each	20
FBR-11	10-1/2"Dia x 6"H	9"	Each	20

STEAM TABLE PANS, STAINLESS STEEL

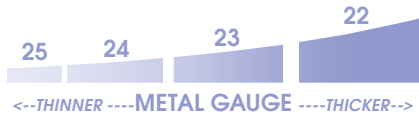

- ◆ Winco® offers the most complete collection of steam table pans in the industry
- ◆ Anti-jamming pans available in all gauges; straight sided pans available in standard weight
- ◆ Every gauge weight is made of 18/8 stainless steel
- ◆ NSF listed

NSF STEAM TABLE PANS



ADD 30% MORE COUNTER CAPACITY!

NSF SPJH-906GN

WINCO® EXCLUSIVE SIZE



HEAVYWEIGHT

TRUE 24 GAUGE ANTI-JAMMING

TRUE 23 GAUGE ANTI-JAMMING

TRUE 22 GAUGE ANTI-JAMMING

SIZE	DEPTH	UOM	CASE	ITEM	ITEM	ITEM
Full-Size 20-3/4" x 12-3/4"	1-1/4"	Each	6/12	SPJM-102 SPJM-104 SPJM-106	SPJP-102 SPJP-104 SPJP-106	SPJH-101 SPJH-102 SPJH-104 SPJH-106
	2-1/2"	Each	6/12			
	4"	Each	6/12			
	6"	Each	6/12			
Half-Size 10-3/8" x 12-3/4"	1-1/4"	Each	12/24	SPJM-202 SPJM-204 SPJM-206	SPJP-202 SPJP-204 SPJP-206	SPJH-201 SPJH-202 SPJH-204 SPJH-206
	2-1/2"	Each	12/24			
	4"	Each	6/24			
	6"	Each	6/12			
Third-Size 6-7/8" x 12-3/4"	2-1/2"	Each	12/48	SPJM-302 SPJM-304 SPJM-306	SPJP-302 SPJP-304 SPJP-306	SPJH-302 SPJH-304 SPJH-306
	4"	Each	12/24			
	6"	Each	12/24			
Quarter-Size 10-5/6" x 6-5/16"	2-1/2"	Each	12/72	SPJM-402 SPJM-404 SPJM-406	SPJP-402 SPJP-404 SPJP-406	SPJH-402 SPJH-404 SPJH-406
	4"	Each	12/48			
	6"	Each	12/24			
Sixth-Size 6-7/8" x 6-5/16"	2-1/2"	Each	12/72	SPJM-602 SPJM-604 SPJM-606	SPJP-602 SPJP-604 SPJP-606	SPJH-602 SPJH-604 SPJH-606
	4"	Each	12/48			
	6"	Each	12/48			
Ninth-Size 6-3/4" x 4-1/4"	2-1/2"	Each	12/72	SPJM-902 SPJM-904	SPJP-902 SPJP-904	SPJH-902 SPJH-904 SPJH-906GN
	4"	Each	12/72			
	6"	Each	12/24			
Eighteenth Size 4-1/4" x 3-1/2"	2"	Each	24/96			SPJH-1802



NSF SPJH-1802

STANDARD WEIGHT

25 GAUGE STRAIGHT-SIDED

25 GAUGE ANTI-JAMMING

SIZE	DEPTH	UOM	CASE	ITEM	ITEM
Full-Size 20-3/4" x 12-3/4"	1-1/4"	Each	6/12	SPF1 SPF2 SPF4 SPF6	SPJL-102 SPJL-104 SPJL-106
	2-1/2"	Each	6/12		
	4"	Each	6/12		
	6"	Each	6/12		
Two-Third Size 14" x 12-7/8"	2-1/2"	Each	12/24	SPTT2 SPTT4 SPTT6	
	4"	Each	6/24		
	6"	Each	6/12		
Half-Size 10-3/8" x 12-3/4"	1-1/4"	Each	12/24	SPH1 SPH2 SPH4 SPH6	SPJL-202 SPJL-204 SPJL-206
	2-1/2"	Each	12/24		
	4"	Each	6/24		
	6"	Each	6/12		
Third-Size 6-7/8" x 12-3/4"	2-1/2"	Each	12/48	SPT2 SPT4 SPT6	SPJL-302 SPJL-304 SPJL-306
	4"	Each	12/24		
	6"	Each	12/24		
Quarter-Size 10-5/6" x 6-5/16"	2-1/2"	Each	12/72	SPQ2 SPQ4 SPQ6	SPJL-402 SPJL-404 SPJL-406
	4"	Each	12/48		
	6"	Each	12/24		
Sixth-Size 6-7/8" x 6-5/16"	2-1/2"	Each	12/72	SPS2 SPS4 SPS6	SPJL-602 SPJL-604 SPJL-606
	4"	Each	12/48		
	6"	Each	12/48		
Ninth-Size 6-3/4" x 4-1/4"	2-1/2"	Each	12/72	SPN2 SPN4	SPJL-902 SPJL-904
	4"	Each	12/72		



Anti-jamming



Straight-sided

NSF STEAM TABLE PANS

**GET-A-GRIP™ CHAFING DISH FOOD PAN**

- ◆ Patented pan and handle system prevents steam burns
- ◆ Stainless steel

ITEM	DESCRIPTION	UOM	CASE
SPF2-HD	Full-Size w/Handles	Each	6

**SPECIALTY PANS**



Patented handle system



SPF2-HD

**22 GAUGE PERFORATED STEAM PANS**

- ◆ Stainless steel; anti-jamming; NSF listed

ITEM	DESCRIPTION	DEPTH	UOM	CASE
SPJH-102PF	Full-Size, Perf'd	2-1/2"	Each	6/12
SPJH-104PF	Full-Size, Perf'd	4"	Each	6/12
SPJH-106PF	Full-Size, Perf'd	6"	Each	6/12
SPJH-202PF	Half-Size, Perf'd	2-1/2"	Each	12/24
SPJH-204PF	Half-Size, Perf'd	4"	Each	6/24
SPJH-206PF	Half-Size, Perf'd	6"	Each	6/12



SPJH-SERIES



SPJH/SPFP-SERIES PERFORATED STEAM PANS

SPFP-SERIES



**25 GAUGE PERFORATED STEAM PANS**

- ◆ Stainless steel; NSF listed

ITEM	DESCRIPTION	DEPTH	UOM	CASE
SPFP2	Full-Size, Perf'd	2-1/2"	Each	6/12
SPFP4	Full-Size, Perf'd	4"	Each	6/12
SPFP6	Full-Size, Perf'd	6"	Each	6/12
SPHP2	Half-Size, Perf'd	2-1/2"	Each	6/24
SPHP4	Half-Size, Perf'd	4"	Each	6/24
SPHP6	Half-Size, Perf'd	6"	Each	6/12

Ample holes allow drainage, also great for steaming

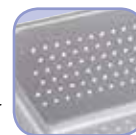

**22 GAUGE HALF LONG STEAM PANS**

- ◆ Stainless steel; anti-jamming; NSF listed

ITEM	DESCRIPTION	DEPTH	UOM	CASE
SPJH-2HL	Half Long Pan	2-1/2"	Each	6/24
SPJH-4HL	Half Long Pan	4"	Each	6/24
SPJH-6HL	Half Long Pan	6"	Each	6/12



SPJH-SERIES



SPJH/SPJL-SERIES HALF LONG STEAM PANS

SPJL-SERIES



**25 GAUGE HALF LONG STEAM PANS**

- ◆ Stainless steel; anti-jamming; NSF listed

ITEM	DESCRIPTION	DEPTH	UOM	CASE
SPJL-2HL	Half Long Pan	2-1/2"	Each	6/24
SPJL-4HL	Half Long Pan	4"	Each	6/24
SPJL-6HL	Half Long Pan	6"	Each	6/12



SPFD2



**DIVIDED FOOD PANS**

- ◆ Stainless steel

ITEM	DESCRIPTION	DEPTH	UOM	CASE
SPFD2	Full-Size, Two Sections, NSF	2-1/2"	Each	6/12
SPFD-2R	15-1/4" Dia Round, Two Sections, Fits 103A, 103B, 602 and 308A Chafers	2-1/2"	Each	10



SPFD-2R

**WATER & SPILLAGE PANS**

- ◆ Stainless steel

ITEM	DESCRIPTION	DEPTH	UOM	CASE
C-WPF	Full-Size Water Pan, Dripless Edge	4"	Each	6
C-WPF6	Full-Size Spillage Pan, Upright Standing Edge, NSF	6"	Each	5/10
C-WPP	Full-Size Spillage Pan, Flat Edge, NSF	6"	Each	6/12

**WATER & SPILLAGE PANS**



Upright Standing Edge



C-WPF6



Dripless Edge



C-WPF



Flat Edge



C-WPP



## ROLL-TOP COVER



C-RCF

SEE PAGE 224 FOR FOOD PAN

## ROLL-TOP COVER

- ◆ 18/8 satin finish stainless steel
- ◆ Fits full-size 12" x 20" food well opening
- ◆ Easy access hinged cover
- ◆ Plastic handle is heat resistant up to 220°F (105°C)

ITEM	DESCRIPTION	UOM	CASE
C-RCF	20-3/4"L x 13"W x 11-7/8"H	Each	1/2



Open



Closed on a food pan



Open on a food pan

## STEAM PAN COVERS

NSF SOLID COVERS



SPSCF



SPCF

NSF SLOTTED COVERS

SEE PAGE 231 FOR POLYCARBONATE COVERS



C-HFC1



C-HDC



C-DCF



C-DCH



SPJL-HCN



SPJL-HCS

## FLAT COVERS

- ◆ Center handle for easy opening and closing
- ◆ 18/8 stainless steel
- ◆ NSF listed

ITEM	DESCRIPTION	UOM	CASE
SPSCF	1/1 Solid Cover	Each	12/24
SPSCH	1/2 Solid Cover	Each	12/48
SPSCT	1/3 Solid Cover	Each	12/72
SPSCQ	1/4 Solid Cover	Each	12/72
SPSCS	1/6 Solid Cover	Each	12/72
SPSCN	1/9 Solid Cover	Each	12/72
SPSCN-GN	1/9 Solid Cover for SPJH-906GN	Each	10/40
SPSCTT	2/3 Solid Cover	Each	12/24
SPCF	1/1 Slotted Cover	Each	12/24
SPCH	1/2 Slotted Cover	Each	12/48
SPCT	1/3 Slotted Cover	Each	12/72
SPCQ	1/4 Slotted Cover	Each	12/72
SPCS	1/6 Slotted Cover	Each	12/72
SPCN	1/9 Slotted Cover	Each	12/72
SPCN-GN	1/9 Slotted Cover for SPJH-906GN	Each	10/40
SPCTT	2/3 Slotted Cover	Each	12/24

## HINGED COVERS

ITEM	DESCRIPTION	UOM	CASE
C-HFC1	Full-Size Flat Hinged Cover with Handles	Each	6/12
C-HDC	Full-Size Hinged Dome Cover with Handles	Each	12

## DOME COVERS

ITEM	DESCRIPTION	UOM	CASE
C-DCF	Full-Size Dome Cover with Handle	Each	12
C-DCH	Half-Size Dome Cover with Handle	Each	24

## HALF LONG COVERS

ITEM	DESCRIPTION	UOM	CASE
SPJL-HCN	Half Long Cover, Notched	Each	12/24
SPJL-HCS	Half Long Cover, Solid	Each	12/24

## ANGLED DISPLAY ADAPTOR



ADB-4

## ANGLED DISPLAY ADAPTOR

Add some dimension to a buffet with an angled display adaptor to give steam table pans a lift so guests can have better visibility and easier access to food.

ITEM	DESCRIPTION	UOM	CASE
ADB-4	Full-Size, S/S	Each	2/6

### STAINLESS STEEL STEAM PAN GRATES

- ◆ Feet elevate food to keep from sticking to steam pan
- ◆ Can also be used as a cooling or icing rack
- ◆ Rust resistant

ITEM	DESCRIPTION	STEAM PAN SIZE	UOM	CASE
PGWS-1018	For Full-Size	10" x 18"	Each	12/48
PGWS-810	For Half-Size	8" x 10"	Each	12/48
PGWS-510	For Third-Size	5" x 10-1/2"	Each	12/48

### STEAM PAN GRATES

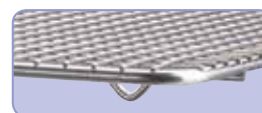

Raised Feet

SEE PAGE 239 FOR SHEET PAN GRATES

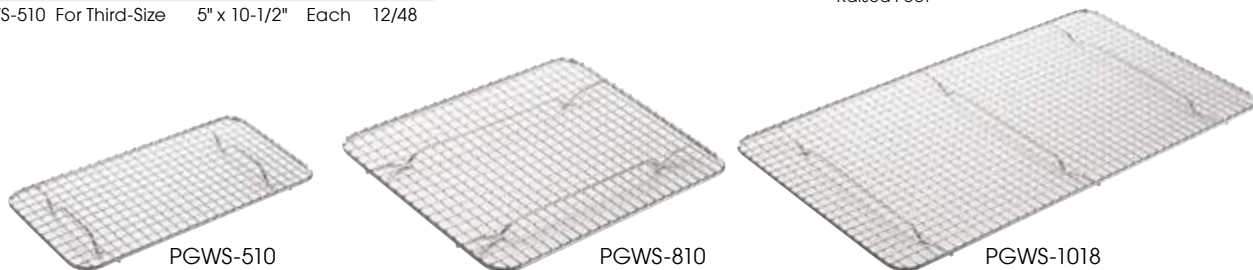

### CHROME-PLATED STEAM PAN GRATES

ITEM	DESCRIPTION	STEAM PAN SIZE	UOM	CASE
PGW-1018	For Full-Size	10" x 18"	Each	12/48
PGW-810	For Half-Size	8" x 10"	Each	12/48
PGW-510	For Third-Size	5" x 10-1/2"	Each	12/48

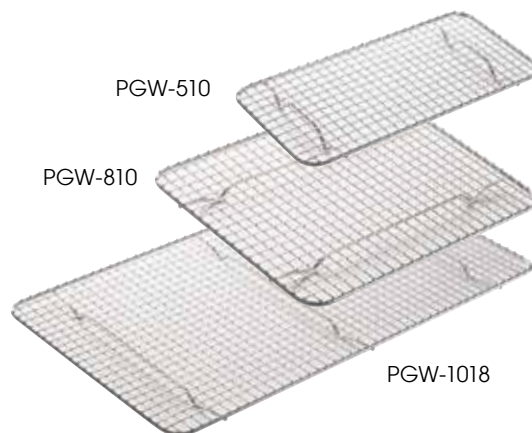

### FALSE BOTTOMS

- ◆ 18/8 stainless steel
- ◆ Rust resistant
- ◆ Fits standard steam pan sizes
- ◆ NSF listed

ITEM	DESCRIPTION	UOM	CASE
SPFB-1	Full-Size	Each	10/20
SPFB-2	Half-Size	Each	10/40
SPFB-3	Third-Size	Each	12/48
SPFB-4	Quarter-Size	Each	12/48
SPFB-6	Sixth-Size	Each	12/72
SPFB-9	Ninth-Size	Each	12/72

### FALSE BOTTOMS

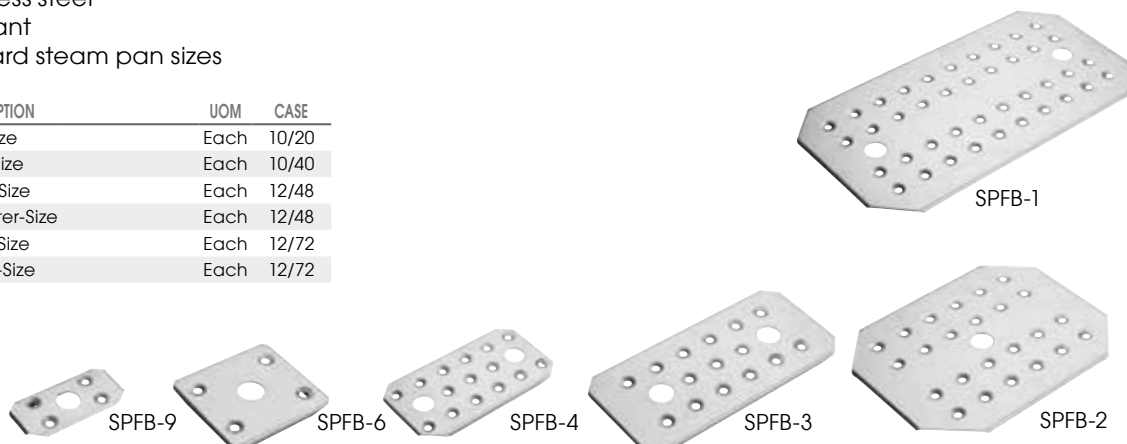

SPFB-SERIES

### ADAPTOR BARS

- ◆ Stainless steel

ITEM	DESCRIPTION	UOM	CASE
ADB-12	12"L x 1"W	Each	12/144
ADB-20	20"L x 1"W	Each	12/120

### ADAPTOR BARS



ADB-SERIES



## Step up to Winco® Prime – A Cut Above

Winco Prime products are made with industry approved materials that comply with or exceed accepted industry standards. All products in the Winco Prime family are NSF® listed to give a comfort level that every effort has been made to provide a safe and durable product at an affordable price. Winco Prime products are safe to be used and will hold up well in the most demanding food service environment!

### NSF® BAIN-MARIES

### NSF® INSETS



BAMN-6



BAMN-6C



INSN-7



INSC-7M

#### WINCO® PRIME BAIN-MARIES

◆ Stainless steel satin finish

ITEM	DESCRIPTION	SIZE	UOM	CASE
BAMN-1.25	1.25 Qt	5" x 6"	Each	6/48
BAMN-1.5	1.5 Qt	5-1/2" x 5-1/4"	Each	6/48
BAMN-2	2 Qt	5-3/4" x 7"	Each	6/48
BAMN-3.5	3.5 Qt	7-1/4" x 7"	Each	6/36
BAMN-4.25	4.25 Qt	7-1/4" x 7-3/4"	Each	6/36
BAMN-6	6 Qt	8" x 8-3/4"	Each	6/24
BAMN-8.25	8.25 Qt	9" x 9-3/4"	Each	6/24
BAMN-12	12 Qt	10" x 10-1/2"	Each	6/12

#### BAIN-MARIE COVERS

◆ Stainless steel satin finish

ITEM	DESCRIPTION	UOM	CASE
BAMN-1.25C	Cover for BAMN-1.25	Each	12/144
BAMN-1.5C	Cover for BAMN-1.5	Each	12/144
BAMN-2C	Cover for BAMN-2	Each	12/144
BAMN-3.5C	Cover for BAMN-3.5	Each	12/144
BAMN-4.25C	Cover for BAMN-4.25	Each	12/72
BAMN-6C	Cover for BAMN-6	Each	12/72
BAMN-8.25C	Cover for BAMN-8.25	Each	12/48
BAMN-12C	Cover for BAMN-12	Each	12/24

#### WINCO® PRIME INSET PANS

◆ Stainless steel satin finish

ITEM	DESCRIPTION	SIZE	UOM	CASE
INSN-2.5	2.5 Qt	6" x 7-1/2"	Each	6/36
INSN-4	4 Qt	7-1/2" x 7-1/2"	Each	6/36
INSN-7	7 Qt	9-1/2" x 8"	Each	6/24
INSN-11	11 Qt	11-1/2" x 9"	Each	6/12

#### INSET COVERS (NON-NSF)

◆ Stainless steel mirror finish

ITEM	DESCRIPTION	UOM	CASE
INSC-2.5	Cover for INSN-2.5	Each	6/72
INSC-4	Cover for INSN-4	Each	6/36
INSC-7M	Cover for INSN-7	Each	6/48
INSC-11M	Cover for INSN-11	Each	6/36

### BAIN-MARIES

- ◆ Stainless steel mirror finish
- ◆ Bent rim for easier handling and lifting

ITEM	DESCRIPTION	SIZE	UOM	CASE
BAM-1.25	1.25 Qt	5" x 6"	Each	6/48
BAM-1.5	1.5 Qt	5-1/2" x 5-1/4"	Each	6/48
BAM-2	2 Qt	5-3/4" x 7"	Each	6/48
BAM-3.5	3.5 Qt	7-1/4" x 7"	Each	6/36
BAM-4.25	4.25 Qt	7-1/4" x 7-3/4"	Each	6/36
BAM-6	6 Qt	8" x 8-3/4"	Each	6/24
BAM-8.25	8.25 Qt	9" x 9-3/4"	Each	6/24
BAM-12	12 Qt	10" x 10-1/2"	Each	3/6

### BAIN-MARIE COVERS

- ◆ Stainless steel mirror finish

ITEM	DESCRIPTION	UOM	CASE
BAMC-1.25	For 1.25 Qt Bain Marie	Each	12/144
BAMC-2	For 2 Qt Bain Marie	Each	12/144
BAMC-3.5	For 3.5 Qt Bain Marie	Each	12/144
BAMC-4.25	For 4.25 Qt Bain Marie	Each	12/72
BAMC-6	For 6 Qt Bain Marie	Each	12/72
BAMC-8.25	For 8.25 Qt Bain Marie	Each	12/48
BAMC-12	For 12 Qt Bain Marie	Each	12/24

### INSET PAN

- ◆ Stainless steel mirror finish

ITEM	DESCRIPTION	SIZE	UOM	CASE
INS-2.5	2.5 Qt	6" x 7-1/2"	Each	6/36
INS-4.0	4 Qt	7-1/2" x 7-1/2"	Each	6/36
INS-7.0M	7 Qt, 24 gauge	9-1/2" x 8"	Each	6/24
INS-11.0M	11 Qt, 24 gauge	11-1/2" x 9"	Each	6/12

### INSET COVERS

- ◆ Stainless steel mirror finish

ITEM	DESCRIPTION	UOM	CASE
INSC-2.5	For 2.5 Qt Inset	Each	6/72
INSC-4	For 4 Qt Inset	Each	6/36
INSC-7M	For 7 Qt Inset	Each	6/48
INSC-11M	For 11 Qt Inset	Each	6/36

### HINGED COVERS

- ◆ Stainless steel mirror finish

ITEM	DESCRIPTION	UOM	CASE
INSH-7	For 7 Qt Inset	Each	6/24
INSH-11	For 11 Qt Inset	Each	6/24

### STAINLESS STEEL ADAPTOR PLATES

- ◆ 12" x 20" overall size

ITEM	DESCRIPTION	SIZE	UOM	CASE
ADP-608	6-3/8" and 8-3/8" Inset Holes	Fits 4 Qt and 7 Qt	Each	10
ADP-610	6-3/8" and 10-3/8" Inset Holes	Fits 4 Qt and 11 Qt	Each	10
ADP-666	Three 6-3/8" Inset Holes	Fits 4 Qt	Each	10
ADP-808	Two 8-3/8" Inset Holes	Fits 7 Qt	Each	10
ADP-810	8-3/8" and 10-3/8" Inset Holes	Fits 7 Qt and 11 Qt	Each	10
ADP-444	Adaptor Plate, Six 4-3/4" Inset Holes	Fits 2.5 Qt	Each	10

### BAIN-MARIES



BAM-6



BAMC-SERIES

### INSETS



INS-7.0M



INSC-7M

INSH-7

### ADAPTOR PLATES

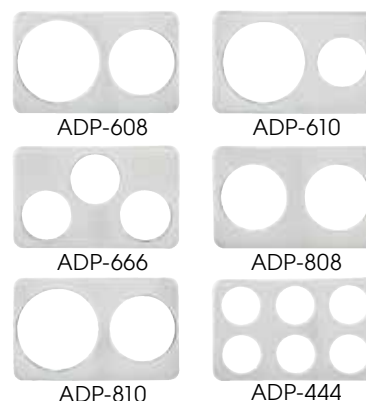

OVERALL SIZE: 21" X 13"

STAINLESS STEEL  
STEAM TABLE PAN/  
FOOD PAN RACKS



36-TIER  
CAPACITY UP  
TO 1,000 LBS

SRK-36  
Fits a combination of full,  
half or third-size pans

STAINLESS STEEL STEAM TABLE PAN/FOOD PAN RACKS

- ◆ Stainless steel construction
- ◆ Customize with a variety of steam table pans and food pans for the best configuration
- ◆ Dual-ended locking bars prevent pans from sliding out
- ◆ Caster bumpers protect walls, doors and rack during minor collisions
- ◆ Channel ledges are tightly welded to rails providing better support for pans
- ◆ 4" dia double-bearing, full-swivel casters help stabilize weight capacity
- ◆ Capacities: up to 1,000 Lbs (SRK-36) or up to 500 Lbs (SRK-12, SRK-12D)
- ◆ Ships knocked down
- ◆ 1-1/2" and 1-3/4" spacing between each tier

FULL HEIGHT RACKS - 36-TIER

ITEM	DESCRIPTION	SIZE	UOM	CASE
SRK-36	36-Tier END-LOAD Rack	15-1/8"L x 21-5/8"W x 63-1/4"H	Set	1

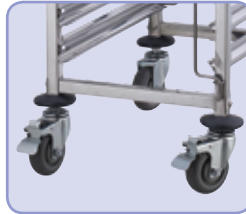

Caster bumpers protect  
walls, doors and rack  
against minor collisions



SEE PAGE 224  
FOR STEAM  
TABLE PANS

Customize with a variety of  
steam table pans and food pans  
for the best configuration

UNDER-COUNTER RACKS - 12-TIER

ITEM	DESCRIPTION	SIZE	UOM	CASE
SRK-12	12-Tier END-LOAD Rack	15-1/8"L x 21-5/8"W x 31-1/2"H	Set	1
SRK-12D	12-Tier SIDE-LOAD Rack	23-1/4"L x 26"W x 31-1/2"H	Set	1

REPLACEMENT CASTERS

ITEM	DESCRIPTION	SIZE	UOM	CASE
SRK-CT	Caster for SRK-Series		Each	4/16
SRK-CTB	Caster w/Brake for SRK-Series		Each	4/16

NEW  
SIZES  
12-TIER  
CAPACITY UP  
TO 1,000 LBS



SRK-12  
Fits a combination of full,  
half or third-size pans



SRK-12D  
Fits full-size pans only, two per tier



SRK-CT  
4" caster



SRK-CTB  
4" caster with brake



# POLYCARBONATE FOOD PANS

## PAN SIZING

SIZE	DIMENSIONS
Full-Size	20-3/4" x 12-1/2"
1/2-Size	12-3/4" x 10-3/8"
1/3-Size	12-5/8" x 6-7/8"
1/4-Size	10-1/4" x 6-1/4"
1/6-Size	6-3/4" x 6-1/4"
1/9-Size	6-7/8" x 4-1/4"

WITHSTAND  
TEMPS FROM  
-40°F TO 210°F



SP7906

SEE PAGE 227  
FOR ADAPTOR  
BARS

## FOOD PANS

◆ NSF listed

ITEM	PAN SIZE	DEPTH	UOM	CASE
SP7102	Full-Size	2-1/2"	Each	6/12
SP7104	Full-Size	3-1/2"	Each	6/12
SP7106	Full-Size	5-1/2"	Each	6/12
SP7108	Full-Size	7-3/4"	Each	6/12
SP7202	1/2-Size	2-1/2"	Each	12/24
SP7204	1/2-Size	3-1/2"	Each	6/24
SP7206	1/2-Size	5-1/2"	Each	6/12
SP7208	1/2-Size	7-3/4"	Each	6/12
SP7302	1/3-Size	2-1/2"	Each	12/24
SP7304	1/3-Size	3-1/2"	Each	12/24
SP7306	1/3-Size	5-1/2"	Each	6/24
SP7308	1/3-Size	7-3/4"	Each	6/12
SP7402	1/4-Size	2-1/2"	Each	12/36
SP7404	1/4-Size	3-1/2"	Each	12/36
SP7406	1/4-Size	5-1/2"	Each	6/24
SP7602	1/6-Size	2-1/2"	Each	12/36
SP7604	1/6-Size	3-1/2"	Each	12/48
SP7606	1/6-Size	5-1/2"	Each	6/24
SP7902	1/9-Size	2-1/2"	Each	12/72
SP7904	1/9-Size	3-1/2"	Each	12/72
SP7906	1/9-Size	6"	Each	12/72

## COVERS FOR FOOD PANS

◆ NSF listed

ITEM	COVER STYLE	UOM	CASE
SP7100C	Slotted	Each	12/24
SP7100S	Solid	Each	12/24
SP7200C	Slotted	Each	12/48
SP7200S	Solid	Each	12/48
SP7300C	Slotted	Each	12/72
SP7300S	Solid	Each	12/72
SP7400C	Slotted	Each	12/72
SP7400S	Solid	Each	12/72
SP7600C	Slotted	Each	12/72
SP7600S	Solid	Each	12/72
SP7900C	Slotted	Each	12/72
SP7900S	Solid	Each	12/72

NSF

## DOMES COVERS

- ◆ Made of durable polycarbonate plastic
- ◆ C-DP1, C-DPF1 and C-DPFH fit full-size steam table pans and poly pans
- ◆ C-DP2 and C-DPF2 fit half-size steam table pans and poly pans
- ◆ NSF listed

ITEM	DESCRIPTION	SIZE	UOM	CASE
C-DP1	Full-Size Cover, NSF	21-1/2" x 13-3/4"	Each	12
C-DP2	1/2-Size Cover, NSF	13-1/2" x 11"	Each	24
C-DPF1	Full-Size Flip Cover, NSF	21-1/2" x 13-3/4"	Each	12
C-DPF2	1/2-Size Cut-out Cover, NSF	13-1/2" x 11"	Each	24
C-DPFH	Full-Size Hinged Cover	21" x 13"	Each	12



DOMES COVERS NSF

SP79DS

SP7-SERIES NSF

## DRAIN SHELVES

◆ NSF listed

ITEM	DESCRIPTION	SIZE	UOM	CASE
SP71DS	Full-Size	18-5/16" x 10-1/4"	Each	10/20
SP72DS	1/2-Size	10-1/4" x 7-7/8"	Each	10/40
SP73DS	1/3-Size	10-1/4" x 4-7/16"	Each	20/80
SP74DS	1/4-Size	8" x 3-15/16"	Each	20/80
SP76DS	1/6-Size	4-7/16" x 4-1/4"	Each	20/120
SP79DS	1/9-Size	4-7/16" x 2-1/8"	Each	60/120

## SQUARE FOOD STORAGE CONTAINERS



NSF® PCSC-SERIES



NSF® BPA FREE PTSC-SERIES



NSF® BPA FREE PESC-SERIES

SEE PAGE 295 FOR MORE OF THE ALLERGEN-FREE LINE



PECC-128P, PECC-68P, PECC-24P



PECC-24, PECC-68, PECC-128



PECC-S, PECC-M, PECC-L

Winco® offers a wide selection of NSF listed boxes and containers to meet all your food storage needs. Our food storage containers come in round and square shapes, in both clear polycarbonate (PC) and polypropylene (PP).

- ◆ Clear polycarbonate is extremely durable, stackable, withstands temperatures from -40°F to 210°F, and is ideal for the storage and transport of raw or prepared food
- ◆ Polypropylene is stain resistant, withstands temperatures from -40°F to 160°F, and is ideal for the storage and transport of prepared food only
- ◆ Built-in handles, graduation markings in liters and quarts
- ◆ Dishwasher safe

### CLEAR POLYCARBONATE

- ◆ NSF listed

ITEM	DESCRIPTION	UOM	CASE
PCSC-2C	2 Qt	Each	12/60
PCSC-4C	4 Qt	Each	12/48
PCSC-6C	6 Qt	Each	12/24
PCSC-8C	8 Qt	Each	12/24
PCSC-12C	12 Qt	Each	12
PCSC-18C	18 Qt	Each	12
PCSC-22C	22 Qt	Each	6

### TRANSLUCENT POLYPROPYLENE

- ◆ NSF listed, BPA-free

ITEM	DESCRIPTION	UOM	CASE
PTSC-2	2 Qt	Each	12/60
PTSC-4	4 Qt	Each	12/48
PTSC-6	6 Qt	Each	12/24
PTSC-8	8 Qt	Each	12/24
PTSC-12	12 Qt	Each	12
PTSC-18	18 Qt	Each	12
PTSC-22	22 Qt	Each	6

### WHITE POLYPROPYLENE

- ◆ NSF listed, BPA-free

ITEM	DESCRIPTION	UOM	CASE
PESC-2	2 Qt	Each	12/60
PESC-4	4 Qt	Each	12/48
PESC-6	6 Qt	Each	12/24
PESC-8	8 Qt	Each	12/24
PESC-12	12 Qt	Each	12
PESC-18	18 Qt	Each	12
PESC-22	22 Qt	Each	6

### POLYETHYLENE ALLERGEN-FREE COVERS

Solve the challenges of maintaining an allergen-aware kitchen! Improve customer dining experiences while raising the bar for food safety. Prevent cross-contaminating allergens with the extensive line of Allergen-Free tools by Winco®. Whether it's gluten, nuts or more, use this stand-out purple color to designate these storage containers as allergen-free.

ITEM	DESCRIPTION	COLOR	UOM	CASE
PECC-24P	Fits 2 Qt & 4 Qt	Purple	Each	12
PECC-68P	Fits 6 Qt & 8 Qt	Purple	Each	12
PECC-128P	Fits 12 Qt, 18 Qt, 22 Qt	Purple	Each	6

### POLYETHYLENE COVERS

ITEM	DESCRIPTION	COLOR	UOM	CASE
PECC-24	Fits 2 Qt & 4 Qt	Green	Each	12
PECC-68	Fits 6 Qt & 8 Qt	Red	Each	12
PECC-128	Fits 12 Qt, 18 Qt, 22 Qt	Blue	Each	6
PECC-S	Fits 2 Qt & 4 Qt	White	Each	12
PECC-M	Fits 6 Qt & 8 Qt	White	Each	12
PECC-L	Fits 12 Qt, 18 Qt, 22 Qt	White	Each	6

Winco® offers a wide selection of NSF listed boxes and containers to meet all your food storage needs. Our food storage containers come in round and square shapes, in both clear polycarbonate and polypropylene.

- ◆ Clear polycarbonate is extremely durable, stackable, withstands temperatures from -40°F to 210°F, and is ideal for the storage and transport of raw or prepared food
- ◆ Polypropylene is stain resistant, withstands temperatures from -40°F to 160°F, and is ideal for the storage and transport of prepared food only
- ◆ Built-in handles, graduation markings in liters and quarts
- ◆ Dishwasher safe

## ROUND FOOD STORAGE CONTAINERS

### CLEAR POLYCARBONATE

- ◆ NSF listed

ITEM	DESCRIPTION	UOM	CASE
PCRC-1	1 Qt	Each	48
PCRC-2	2 Qt	Each	24
PCRC-4	4 Qt	Each	12
PCRC-6	6 Qt	Each	12
PCRC-8	8 Qt	Each	12
PCRC-12	12 Qt	Each	12
PCRC-18	18 Qt	Each	6
PCRC-22	22 Qt	Each	6
PCRC-1C	Cover, Fits 1 Qt	Each	12
PCRC-24C	Cover, Fits 2 Qt and 4 Qt	Each	12
PCRC-68C	Cover, Fits 6 Qt and 8 Qt	Each	12
PCRC-1222C	Cover, Fits 12 Qt, 18 Qt, 22 Qt	Each	6



PCRC-SERIES **NSF**

### TRANSLUCENT POLYPROPYLENE

- ◆ NSF listed, BPA-free

ITEM	DESCRIPTION	UOM	CASE
PTRC-1	1 Qt	Each	48
PTRC-2	2 Qt	Each	24
PTRC-4	4 Qt	Each	12
PTRC-6	6 Qt	Each	12
PTRC-8	8 Qt	Each	12
PTRC-12	12 Qt	Each	12
PTRC-18	18 Qt	Each	6
PTRC-22	22 Qt	Each	6
PTRC-1C	Cover, Fits 1 Qt	Each	12
PTRC-24C	Cover, Fits 2 Qt and 4 Qt	Each	12
PTRC-68C	Cover, Fits 6 Qt and 8 Qt	Each	12
PTRC-1222C	Cover, Fits 12 Qt, 18 Qt, 22 Qt	Each	6



PTRC-SERIES **NSF**  
**BPA FREE**

### WHITE POLYPROPYLENE

- ◆ NSF listed, BPA-free

ITEM	DESCRIPTION	UOM	CASE
PPRC-1W	1 Qt	Each	48
PPRC-2W	2 Qt	Each	24
PPRC-4W	4 Qt	Each	12
PPRC-6W	6 Qt	Each	12
PPRC-8W	8 Qt	Each	12
PPRC-12W	12 Qt	Each	12
PPRC-18W	18 Qt	Each	6
PPRC-22W	22 Qt	Each	6
PPRC-1C	Cover, Fits 1 Qt	Each	12
PPRC-24C	Cover, Fits 2 Qt and 4 Qt	Each	12
PPRC-68C	Cover, Fits 6 Qt and 8 Qt	Each	12
PPRC-1222C	Cover, Fits 12 Qt, 18 Qt, 22 Qt	Each	6



PPRC-SERIES **NSF**  
**BPA FREE**

## FOOD STORAGE BOXES

NEW SIZE



NSF PFSF & PFSH-SERIES

PFSF-C



AVAILABLE IN JULY 2020

PFSF-3

NEW



PFSF-5C

AVAILABLE IN JULY 2020

PFSF-8C



Perforations along bottom and all sides



Use with PFSF-6

NSF PFSF-SERIES COLANDERS

PFFW-C



NSF

BPA FREE

PFFW & PFHW-SERIES

## HEAVYWEIGHT CLEAR POLYCARBONATE

- ◆ Full-size measures 18" x 26"
- ◆ Half-size measures 18" x 12"
- ◆ Withstands temperatures from -40°F (-40°C) to 212°F (100°C)
- ◆ NSF listed

ITEM	DESCRIPTION	CAPACITY	UOM	CASE
PFSF-3	Full-Size 3-1/2"	5 gal	Each	1/8
PFSF-6	Full-Size 6"	9 gal	Each	6
PFSF-9	Full-Size 9"	13 gal	Each	4
PFSF-12	Full-Size 12"	17 gal	Each	3
PFSF-15	Full-Size 15"	22 gal	Each	3
PFSF-C	Full-Size Cover for PFSF-Series		Each	12
PFSH-3	Half-Size 3-1/2"	1.75 gal	Each	12
PFSH-6	Half-Size 6"	3.5 gal	Each	6
PFSH-9	Half-Size 9"	5 gal	Each	6
PFSH-C	Half-Size Cover for PFSH-Series		Each	24

## HEAVYWEIGHT CLEAR POLYCARBONATE FOOD BOX COLANDERS

Whether used alone or in a compatible food storage box, effectively drain fruits & vegetables, thaw meats or keep seafood on ice with these colanders.

- ◆ Stands up to hot, cold or frozen food items
- ◆ Withstands temperatures from -40°F (-40°C) to 212°F (100°C)
- ◆ NSF listed

ITEM	DESCRIPTION	UOM	CASE
PFSF-5C	5" Deep, For PFSF-6	Each	6
PFSF-8C	8" Deep, For PFSF-9	Each	6

## WHITE POLYPROPYLENE

- ◆ Full-size measures 18" x 26"
- ◆ Half-size measures 18" x 12"
- ◆ Withstands temperatures from -40°F (-40°C) to 160°F (71°C)
- ◆ NSF listed, BPA-free

ITEM	DESCRIPTION	CAPACITY	UOM	CASE
PFFW-3	Full-Size 3"	5 gal	Each	6
PFFW-6	Full-Size 6"	9 gal	Each	6
PFFW-9	Full-Size 9"	13 gal	Each	6
PFFW-12	Full-Size 12"	17 gal	Each	6
PFFW-15	Full-Size 15"	22 gal	Each	6
PFFW-C	Full-Size Cover for PFFW-Series		Each	6
PFHW-3	Half-Size 3"	1.75 gal	Each	12
PFHW-6	Half-Size 6"	3.5 gal	Each	12
PFHW-9	Half-Size 9"	5 gal	Each	12
PFHW-C	Half-Size Cover for PFHW-Series		Each	6

## DRAIN SHELVES



PFSF-DS

NSF DRAIN SHELVES

## POLYCARBONATE DRAIN SHELVES

- ◆ NSF listed

ITEM	DESCRIPTION	SIZE	UOM	CASE
PFSF-DS	Drain Shelf for PFSF	18" x 26"	Each	12
PFSH-DS	Drain Shelf for PFSH	12" x 18"	Each	24

### POLYPROPYLENE DRY INGREDIENT MOBILE BINS

- ◆ Ideal durable mobile storage for dry bulk ingredients
- ◆ Space-efficient under-counter height
- ◆ Advanced super-clasp slanted lid design easily slides open to scoop ingredients; when closing, lid slides over the bin to reduce possible debris on the lid from falling in
- ◆ Quickly view contents through the clear cover to identify ingredients and manage inventory
- ◆ Four 3" caster wheels (2 fixed & 2 swivel w/brakes)
- ◆ Built-in storage holds the included scoop, effectively keeping the handle out of ingredients
- ◆ NSF listed

ITEM	DESCRIPTION	SIZE	UOM	CASE
IB-21	21 Gallon	13" x 29-1/4" x 28"	Set	1
IB-27	27 Gallon	15-1/2" x 29-1/2" x 28"	Set	1
IB-C3	Fixed Caster	3" Dia, Fits IB-21 & -27	Each	1
IB-C3B	Swivel Caster w/Brake	3" Dia, Fits IB-21 & -27	Each	1
IB-21-LE	Lid	Fits IB-21	Each	6
IB-27-LE	Lid	Fits IB-27	Each	6

ITEM #	WEIGHT SUGAR	WEIGHT FLOUR
IB-21	159 lbs	124 lbs
IB-27	197 lbs	154 lbs



IB-C3  
Fixed caster



IB-C3B  
Swivel caster with brake



Built-in storage holds scoop

### DRY BULK INGREDIENT MOBILE BINS



IB-21



IB-27

IB-SERIES



### POLYPROPYLENE DRY INGREDIENT SHELF BINS

- ◆ Stackable for more storage space
- ◆ One-handed lift lid design to increase efficiency
- ◆ Clear plastic polycarbonate front lid to quickly identify ingredients
- ◆ Scoop with dedicated clip to ensure sanitation compliance
- ◆ NSF listed

ITEM	DESCRIPTION	SIZE	UOM	CASE
IB-2S	2 Gallon, 40 Cup	11-3/4" x 14-1/4" x 8-3/8"	Each	1
IB-5S	5 Gallon, 80 Cup	11-1/8" x 23-3/8" x 16-7/8"	Each	1
IB-10S	10 Gallon, 150 Cup	19-1/4" x 23-3/8" x 16-7/8"	Each	1

### DRY BULK INGREDIENT SHELF BINS



IB-10S



IB-5S



IB-2S

IB-SERIES



## FOOD STORAGE CONTAINERS



FCW-32 & FCW-32RC



FCW-32L  
24-3/8" Dia

**NSF** FCW-SERIES

**BPA FREE** CONTAINERS & SOLID LIDS

## POLYETHYLENE FOOD STORAGE CONTAINERS

◆ Lids sold separately, NSF listed

ITEM	DESCRIPTION	UOM	CASE
FCW-10	Container, 10 Gal	Each	1/6
FCW-20*	Container, 20 Gal	Each	1/6
FCW-32*	Container, 32 Gal	Each	1/6
FCW-10L	PP Lid for FCW-10	Each	1/24
FCW-20L	PP Lid for FCW-20	Each	1/12
FCW-32L	PP Lid for FCW-32	Each	1/12
FCW-10RC	PC Rotating Lid for FCW-10	Each	1/6
FCW-20RC	PC Rotating Lid for FCW-20	Each	1/6
FCW-32RC	PC Rotating Lid for FCW-32	Each	1/6

\*Fits DLR-series dollies

ITEM #	CAPACITY (GALLONS)	CAPACITY (CUPS)	FLOUR (LBS)	SUGAR (LBS)
FCW-10	10	150	47	65
FCW-20	20	300	94	130
FCW-32	32	500	156	217

## DELI CROCKS & COVERS



**BPA FREE** CRK-SERIES



CRKC-13

CRKC-10

## DELI CROCKS

The beautiful fluted-finish, combined with durable SAN plastic makes these crocks ideal for deli counter and picnic buffet presentations.

◆ BPA-free

ITEM	DESCRIPTION	COLOR	UOM	CASE
CRK-10R	10" x 7" x 3"	Red	Each	24
CRK-10K	10" x 7" x 3"	Black	Each	24
CRK-10C	10" x 7" x 3"	Clear	Each	24
CRK-10W	10" x 7" x 3"	White	Each	24
CRK-13R	13" x 10" x 3"	Red	Each	12
CRK-13K	13" x 10" x 3"	Black	Each	12
CRK-13C	13" x 10" x 3"	Clear	Each	12
CRK-13W	13" x 10" x 3"	White	Each	12

## COVERS FOR DELI CROCKS

ITEM	DESCRIPTION	COLOR	UOM	CASE
CRKC-10	Cover for CRK-10 Series	Clear	Each	48
CRKC-13	Cover for CRK-13 Series	Clear	Each	48

## BEVERAGE DISPENSER



PBDW-22

**BPA FREE** PBDW-SERIES



## POLYPROPYLENE BEVERAGE CONTAINER/DISPENSER

This container dispenser comes with a secure fit snap-on lid and handle for easy transport.

- ◆ Leak-proof faucet and snap-on lid
- ◆ Bail-style handle with comfortable handgrip
- ◆ Red graduations in liters and quarts
- ◆ Temperature range from -40°F to 160°F
- ◆ Dishwasher safe

ITEM	DESCRIPTION	UOM	CASE
PBDW-22	6 Gal, PP	Each	1/4
PBDW-FS	Faucet for PBDW-22	Each	1

### DOUGH BOXES & COVER

- ◆ Boxes stack tight to maintain freshness of contents
- ◆ Great for storing and proofing dough
- ◆ Reinforced structure resists breakage/bending over time
- ◆ Made of durable polypropylene
- ◆ BPA-free

ITEM	DESCRIPTION	UOM	CASE
PL-3N	25-5/8"L x 18"W x 3-1/4"H	Each	6
PL-6N	25-1/2"L x 17-1/2"W x 6"H	Each	3
PL-36NC	Cover	Each	12



IMPROVED STRUCTURE



Stackable



Reinforced edges & corners

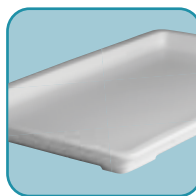

Lid can be used as tray



Seamless fit for fresh storage

NSF®

PL-SERIES

BPA FREE

### WIRE DOUGH BOX DOLLY

Transport multiple dough boxes with ease using this wire dolly, currently the only one on the market!

- ◆ Capacity up to 400 lbs
- ◆ Winco® exclusive
- ◆ Casters measure 3-3/4" diameter each

ITEM	DESCRIPTION	UOM	CASE
DWR-2617	27"L x 18-1/4"W x 2-1/2"H	Each	1
DWR-CT	Caster for DWR-2617	Each	4/24
DWR-CTB	Caster w/ Brake for DWR-2617	Each	4/24



Transport dough boxes

### WIRE DOUGH BOX DOLLY



DWR-2617

## SHEET PANS

**NSF** ALXP-0609



**NEW SIZE**

**NSF** ALXP-1204



Closed bead



ALXP-2216H

**NSF** ALXP-1200



Open bead

**NEW**

**GLAZED**

ALXN-1826P

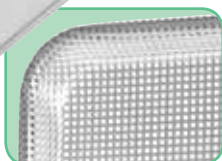

Fully perforated

ALXP-1318P



Perforated

FFT-1826

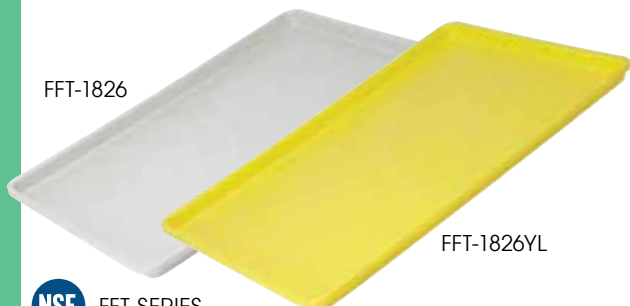

FFT-1826YL

**NSF** FFT-SERIES

## ALUMINUM SHEET PANS

Whether they are reinforced with galvanized wire or extra heavy-duty open bead, Winco® sheet pans can be counted on to hold their shape in high oven temperatures during baking, roasting or broiling.

- ◆ Made of 3003 aluminum
- ◆ Closed bead has galvanized wire for rust resistance and reinforcement
- ◆ Heavy-duty open bead pans ideal for roasting
- ◆ ALXP-0609, -1200 & -1204 are NSF listed

ITEM	DESCRIPTION	SIZE	GAUGE	UOM	CASE
ALXP-0609	1/8-Size Open Bead, NSF	6-1/2" x 9-1/2"	16	Each	24
ALXP-1013	1/4-Size Closed Bead	9-1/2" x 13"	20	Each	24
ALXP-1310H	1/4-Size Closed Bead	10" x 13"	18	Each	24
ALXP-1204	1/4-Size Open Bead, NSF	9-1/2" x 13"	16	Each	24
ALXP-1318	1/2-Size Closed Bead	13" x 18"	20	Each	12
ALXP-1813H	1/2-Size Closed Bead	13" x 18"	18	Each	12
ALXP-1622	2/3-Size Closed Bead	16" x 22"	19	Each	12
ALXP-2216H	2/3-Size Closed Bead	16" x 22"	18	Each	12
ALXP-1826	Full-Size Closed Bead	18" x 26"	18	Each	12
ALXP-2618H	Full-Size Closed Bead	18" x 26"	16	Each	12
ALXP-1200	Full-Size Open Bead, NSF	18" x 26"	12	Each	12

## FULLY PERFORATED ALUMINUM SHEET PANS

Fully perforated for even better air circulation to achieve all-around crispness

- ◆ Closed bead; 3003 aluminum; glazed non-stick coating
- ◆ 3/32" (2.3mm) square perforations

ITEM	DESCRIPTION	SIZE	GAUGE	UOM	CASE
ALXN-1318P	1/2-Size	13" x 18"	16	Each	12
ALXN-1826P	Full-Size	18" x 26"	16	Each	12

## PERFORATED ALUMINUM SHEET PANS

The denser hole perforations on these sheet pans allow for better air circulation and heat conductivity, typically preferred by bakers for a crispier outcome.

- ◆ Closed bead; 3003 aluminum
- ◆ Perforated holes are 1/8" diameter

ITEM	DESCRIPTION	SIZE	GAUGE	UOM	CASE
ALXP-1318P	1/2-Size	13" x 18"	18	Each	12
ALXP-1826P	Full-Size	18" x 26"	18	Each	12
ALXP-2618P	Full-Size	18" x 26"	16	Each	12

## PLASTIC SHEET TRAYS

- ◆ Can also be used as a sheet pan
- ◆ NSF listed

ITEM	DESCRIPTION	COLOR	UOM	CASE
FFT-1826	Full-Size, 18" x 26"	White	Each	12
FFT-1826YL	Full-Size, 18" x 26"	Yellow	Each	6



**POLYPROPYLENE SHEET PAN COVERS**

- ◆ Protects food products during transport or storage
- ◆ Excellent reusable alternative to film or foil
- ◆ Easy snap-on design
- ◆ Dishwasher safe
- ◆ NSF listed
- ◆ BPA-free

ITEM	DESCRIPTION	SIZE	UOM	CASE
CXP-1826	Full-Size	18" x 26"	Each	24
CXP-1318	Half-Size	13" x 18"	Each	24
CXP-1013	Quarter-size	10" x 13"	Each	24

**ALUMINUM SHEET PAN EXTENDERS**

- ◆ Great for making sheet cakes without using a cake pan
- ◆ Flat top edges for easy gripping
- ◆ Flat top of extender also allows sheet pans to be stacked while baked goods cool
- ◆ 2" height
- ◆ Hand wash only

ITEM	DESCRIPTION	SIZE	UOM	CASE
AXPE-1	Full-Size	18" x 26"	Each	12
AXPE-2	Half-Size	13" x 18"	Each	12
AXPE-4	Quarter-Size	9-1/2" x 13"	Each	12

**SHEET PAN COVERS & EXTENDERS**



NSF

CXP-SERIES

BPA FREE



Make sheet cakes without cake pan



AXPE-2

**STAINLESS STEEL WIRE SHEET PAN GRATES**

- ◆ Footed to elevate food to keep from sticking to sheet pan
- ◆ Can also be used as a cooling or icing rack

ITEM	DESCRIPTION	SHEET PAN SIZE	UOM	CASE
PGWS-2416	For Full-Size	16" x 24"	Each	12/24
PGWS-1216	For Half-Size	12" x 16-1/2"	Each	12/48

**SHEET PAN GRATES**



PGWS-1216

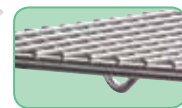

Raised Feet

**CHROME-PLATED WIRE SHEET PAN GRATE**

ITEM	DESCRIPTION	SHEET PAN SIZE	UOM	CASE
PGW-2416	For Full-Size	16" x 24"	Each	12/24
PGW-1420	For 2/3-Size	14" x 20"	Each	12/24
PGW-1216	For Half-Size	12" x 16-1/2"	Each	12/48

SEE PAGE 227 FOR STEAM PAN GRATES

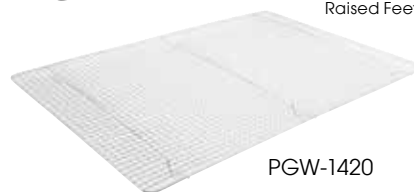

PGW-1420

**ALLERGEN-FREE PURPLE SILICONE BAKING MATS**

Whether it's gluten or nuts, use this stand-out purple color to designate these mats Allergen-Free.

- ◆ Double-sided and reusable up to 2,000 times
- ◆ Provides consistent and even heat distribution
- ◆ Woven fiberglass coated with food grade silicone
- ◆ Temperature tolerance from -40°F (-40°C) to 480°F (248°C)

ITEM	DESCRIPTION	SIZE	UOM	CASE
SBS-11PP	1/4-Size	8-1/4" x 11-3/4"	Each	20/100
SBS-16PP	1/2-Size	11-5/8" x 16-1/2"	Each	10/50
SBS-21PP	2/3-Size	14-7/16" x 20-1/2"	Each	10/50
SBS-24PP	Full-Size	16-3/8" x 24-1/2"	Each	10/50

**SILICONE BAKING MATS**



SBS-21PP

SEE PAGE 295 FOR MORE OF THE ALLERGEN-FREE LINE

Allergen Free

**RECTANGULAR SILICONE BAKING MATS**

- ◆ Reusable up to 2,000 times, use both sides
- ◆ Provides consistent & even heat distribution
- ◆ Woven fiberglass coated with food grade silicone
- ◆ Temperature tolerance from -40°F (-40°C) to 480°F (248°C)
- ◆ NSF listed

ITEM	DESCRIPTION	SIZE	UOM	CASE
SBS-11	1/4-Size	8-1/4" x 11-3/4"	Each	20/100
SBS-16	1/2-Size	11-5/8" x 16-1/2"	Each	10/50
SBS-21	2/3-Size	14-7/16" x 20-1/2"	Each	10/50
SBS-24	Full-Size	16-3/8" x 24-1/2"	Each	10/50

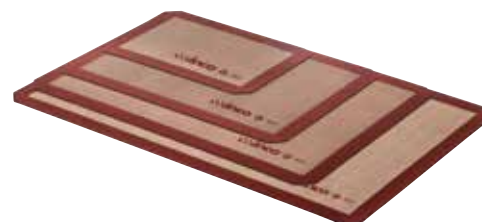

SBS-SERIES (BROWN)

NSF



Winco's exclusive Weld2 System features fail-safe rigidity through both bolting and welding at all critical joints to prevent warping with long term, high-traffic use.



Specialty bolts secure each joint



Bolt caps are welded over completely to form extra- strength juncture

## HEAVY-DUTY ALUMINUM 20-TIER SHEET PAN RACK



### HEAVY DUTY END-LOAD 20-TIER SHEET PAN RACK, WITH BRAKES

*Designed with heavy-duty welded construction and a reinforced base-frame to ensure stability and long-lasting performance.*

- ◆ 20-tier sturdy aluminum construction
- ◆ Designed to hold and transport (20) full-size (18" x 26") sheet pans or 40 (13" x 18") half-size sheet pans
- ◆ 5" dia, full-swivel casters; two (2) with brake
- ◆ Capacity: up to 1,000 Lbs
- ◆ 3" spacing between each tier
- ◆ Fully assembled dimensions: 21-3/4"L x 26"W x 70-1/2"H
- ◆ NSF listed



ITEM	DESCRIPTION	UOM	CASE
AWRK-20HBK	20-Tier, Welded	Each	1
AWRC-5H	Caster for AWRK-20HBK, Heavyweight	Each	12
AWRC-5HK	Caster w/Brake for AWRK-20HBK, Heavyweight	Each	12



Double cross bars for extra strength



5" plate caster with brake

**NSF** AWRK-20HBK

ALUMINUM SHEET PAN RACK

Made for the most demanding restaurant kitchens, these aluminum sheet pan racks accommodate standard full-size 18" x 26" sheet pans, or twice the capacity with half-size 18" x 13" pans.

10-TIER SHEET PAN RACKS

- ◆ Sturdy aluminum construction
- ◆ Hold and transport 10 full-size (18" x 26") sheet pans
- ◆ 5" dia, full-swivel casters; two (2) with brake
- ◆ Capacity: up to 400 Lbs
- ◆ 3" spacing between each tier
- ◆ Ships welded or knocked down
- ◆ Fully assembled dimensions: 21"L x 26-1/2"D x 39"H
- ◆ NSF listed

ITEM	DESCRIPTION	UOM	CASE
AWRK-10	10-Tier, Welded	Each	1
ALRK-10BK	10-Tier, Knocked Down	Each	1
ALRK-10	10-Tier w/o Brakes, Knocked Down	Each	1
ALRC-5ST	Caster for ALRK and AWRK-series	Each	12
ALRC-5STK	Caster w/Brake for ALRK & AWRK-series	Each	12



AWRK-10 NSF  
ALRK-10BK NSF

ALRK-10 NSF

20-TIER END-LOAD SHEET PAN RACKS

- ◆ Sturdy aluminum construction
- ◆ Hold and transport 20 full-size (18" x 26") sheet pans
- ◆ 5" dia, full-swivel casters; two (2) with brake
- ◆ Capacity (ALRK-20R): up to 500 Lbs
- ◆ Capacity (ALRK-20 & ALRK-20BK): up to 700 Lbs
- ◆ Capacity (AWRK-20): up to 800 Lbs
- ◆ 3" spacing between each tier
- ◆ Ships welded or knocked down
- ◆ Fully assembled dimensions (ALRK-20, -20BK, AWRK-20): 21"L x 26-1/2"W x 70"H
- ◆ Fully assembled (ALRK-20R): 20-1/4"L x 26"W x 69-1/4"H
- ◆ NSF listed

ITEM	DESCRIPTION	UOM	CASE
AWRK-20	20-Tier, Welded	Each	1
ALRK-20BK	20-Tier, Knocked Down	Each	1
ALRK-20	20-Tier w/o Brakes, Knocked Down	Each	1
ALRK-20R	20-Tier, Knocked Down, ECONOMY	Each	1
ALRC-5ST	Caster for ALRK-20/-20BK & AWRK-20	Each	12
ALRC-5STK	Caster w/Brake for ALRK-20/-20BK & AWRK-20	Each	12
ALRC-5R	Caster for ALRK-20R	Each	12
ALRC-5RK	Caster w/Brake for ALRK-20R	Each	12



ALRK-20 NSF

AWRK-20 NSF  
ALRK-20BK NSF

30-TIER END-LOAD SHEET PAN RACKS, WITH BRAKES

- ◆ Aluminum construction, 14 gauge
- ◆ Hold and transport 30 full-size (18" x 26") sheet pans
- ◆ 5" dia, heavyweight full-swivel casters; two (2) with brake
- ◆ Capacity: up to 700 Lbs
- ◆ 2" spacing between each tier
- ◆ Ships welded or knocked down
- ◆ Fully assembled dimensions: 21"L x 26-1/2"D x 70"H
- ◆ NSF listed

ITEM	DESCRIPTION	UOM	CASE
AWRK-30	30-Tier, Welded	Each	1
ALRK-30BK	30-Tier, Knocked Down	Set	1
ALRC-5H	Caster for ALRK-30BK, Heavyweight	Each	12
ALRC-5HK	Caster w/Brake for ALRK-30BK, Heavyweight	Each	12



AWRK-30 NSF

ALRK-20R NSF



## ALUMINUM SHEET PAN RACK 20-TIER NESTING RACK, WITH BRAKES

Designed with space-saving in mind, the Z-rack fits snugly with nesting racks to conserve floor space while in storage. The Z-rack accommodates standard full-size or double up with half-size sheet pans.

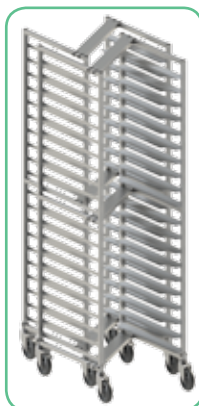
- ◆ 20-tier sturdy aluminum construction
- ◆ Z-frame nesting design for compact storage
- ◆ Capacity: up to 650 lbs & 20 full-size (18" x 26") sheet pans
- ◆ Full-swivel casters; two (2) with brake
- ◆ 3" spacing between each tier
- ◆ Fully assembled: 22" L x 27-1/2"W x 70"H
- ◆ NSF listed



Empty racks nested together

ITEM	DESCRIPTION	UOM	CASE
 AWZK-20	20-Tier, Welded	Each	1
 ALZK-20BK	20-Tier, Knocked Down	Each	1
ALRC-5ST	Caster for ALZK & AWZK-series	Each	12
ALRC-5STK	Caster w/Brake for ALZK & AWZK-series	Each	12



ALRC-5STK  
5" caster with brake

 ALZK-20BK  
AWZK-20



## 20-TIER SIDE-LOAD RACK, WITH BRAKES

Designed with side-load access for alternative convenience in tight kitchen and bakery spaces.

- ◆ 20-tier sturdy aluminum construction
- ◆ Designed to hold and transport (20) full-size (18" x 26") sheet pans
- ◆ 5" dia, full-swivel casters; two (2) with brake
- ◆ Capacity: up to 650 Lbs
- ◆ 3" spacing between each tier
- ◆ Ships welded or knocked down
- ◆ Fully assembled dimensions: 29-1/2"L x 19-1/2"W x 70-3/8"H
- ◆ NSF listed



ITEM	DESCRIPTION	UOM	CASE
 AWRS-20BK	20-Tier, Welded	Each	1
 ALRS-20BK	20-Tier, Knocked Down	Each	1
ALRC-5ST	Caster for ALZK & AWZK-series	Each	12
ALRC-5STK	Caster w/Brake for ALZK & AWZK-series	Each	12



ALRC-5STK  
5" caster with brake

 ALRS-20BK  
AWRS-20BK

### 26-TIER PIZZA PAN RACK, WITH BRAKES

Each tier features an extended ledge to accommodate round or square pizza pans.

- ◆ 26-tier sturdy aluminum construction
- ◆ Designed to hold and transport 17" & 19" dia round pizza pans and 16" & 17" square Sicilian pizza pans
- ◆ 5" dia, full-swivel casters; two (2) with brake
- ◆ Capacity: up to 800 Lbs
- ◆ 2" spacing between each tier
- ◆ 4-1/8" wide ledge for round or square pizza pans
- ◆ Ships welded or knocked down
- ◆ Fully assembled dimensions: 23"L x 21"W x 62-7/8"H
- ◆ NSF listed

ITEM	DESCRIPTION	UOM	CASE
AWPR-26BK	26-Tier, Welded	Each	1
ALPR-26BK	26-Tier, Knocked Down	Each	1
ALRC-5ST	Caster for ALZK & AWZK-series	Each	12
ALRC-5STK	Caster w/Brake for ALZK & AWZK-series	Each	12



### ALUMINUM 26-TIER PIZZA PAN RACK



ALRC-5STK  
5" caster with brake

ALPR-26BK  
AWPR-26BK **NSF**

### STAINLESS STEEL STEAM TABLE PAN/FOOD PAN RACKS

- ◆ Stainless steel construction
- ◆ Customize with a variety of steam table pans and food pans for the best configuration
- ◆ Dual-ended locking bars prevent pans from sliding out
- ◆ Caster bumpers protect walls, doors and rack during minor collisions
- ◆ Channel ledges are tightly welded to rails providing better support for pans
- ◆ 4" dia double-bearing, full-swivel casters help stabilize weight capacity
- ◆ Capacities: up to 1,000 Lbs (SRK-36) or up to 500 Lbs (SRK-12, SRK-12D)
- ◆ Ships knocked down
- ◆ 1-1/2" and 1-3/4" spacing between each tier

ITEM	DESCRIPTION	SIZE	UOM	CASE
SRK-36	36-Tier END-LOAD Rack	15-1/8"L x 21-5/8"W x 63-1/4"H	Set	1
SRK-12	12-Tier END-LOAD Under-Counter Rack	15-1/8"L x 21-5/8"W x 31-1/2"H	Set	1
SRK-12D	12-Tier SIDE-LOAD Under-Counter Rack	23-1/4"L x 26"W x 31-1/2"H	Set	1
SRK-CT	Caster for SRK-Series		Each	4/16
SRK-CTB	Caster w/Brake for SRK-Series		Each	4/16

### STAINLESS STEEL STEAM TABLE PAN/FOOD PAN RACKS

SEE PAGE 224 FOR STEAM TABLE PANS

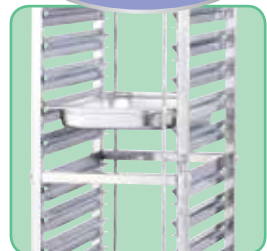

Customize with a variety of steam table pans and food pans for the best configuration

36-TIER CAPACITY UP TO 1,000 LBS



NEW SIZES  
12-TIER CAPACITY UP TO 1,000 LBS



SRK-12  
Fits a combination of full, half or third-size pans



SRK-12D  
Fits full length pans only, two per tier



SRK-CTB  
4" caster with brake



SRK-CT  
4" caster

## ALUMINUM SHEET PAN RACK & TRUCK



NSF ALRK-15

### ALUMINUM END-LOAD COUNTER-HEIGHT SHEET PAN RACK

- ◆ 15 plated-steel wire slides at 1-3/4" spacing
- ◆ Stainless steel solid top is useful as a work surface, and can also help to transport bulky items
- ◆ 14 gauge 6063 aluminum with 1" extruded tube frame
- ◆ Full swivel casters measure 5" diameter x 1-1/4"
- ◆ Holds 15 full-size (18" x 26") or 30 half-size (18" x 13") sheet pans (not included)
- ◆ Capacity: up to 400 lbs
- ◆ Ships knocked down
- ◆ Fully assembled: 20-7/8"L x 26-1/8"W x 31-5/8"H
- ◆ NSF listed

ITEM	DESCRIPTION	UOM	CASE
ALRK-15	15-Tier	Set	1
ALRC-5ST	Caster for ALRK and AWRK-series	Each	12
ALRC-5STK	Caster w/Brake for ALRK & AWRK-series	Each	12



NSF ALRK-3

### ALUMINUM SHEET PAN TRUCK

- ◆ 14 gauge 6063 aluminum with 1" extruded aluminum tube frame
- ◆ Full swivel casters measure 5" diameter x 1-1/4" width
- ◆ Holds 54 full-size (18" x 26") or 108 half-size (13" x 18") sheet pans (not included)
- ◆ Ships knocked down
- ◆ Fully assembled: 28-7/8"L x 20-5/8"W x 33-3/8"H
- ◆ NSF listed

ITEM	DESCRIPTION	UOM	CASE
ALRK-3	Sheet Pan Truck	Set	1
ALRC-5P	Replacement Caster for ALRK-3	Each	12

## WIRE DOLLY



DWR-2617

### WIRE DOUGH BOX DOLLY

*Transport multiple dough boxes with ease using this wire dolly, currently the only one on the market!*

- ◆ Capacity: up to 400 lbs
- ◆ Winco® exclusive
- ◆ Wheels measure 3-3/4" Dia each

ITEM	DESCRIPTION	UOM	CASE
DWR-2617	27"L x 18-1/4"W x 2-1/2"H	Each	1
DWR-CT	Caster for DWR-2617	Each	4/24
DWR-CTB	Caster w/ Brake for DWR-2617	Each	4/24



Transport dough boxes

### SHEET PAN RACK COVERS

ITEM	DESCRIPTION	UOM	CASE
ALRK-10-CV	Cover for 10-Tier Rack	Each	1/12
ALRK-20-CV	Cover for 20-Tier and 30-Tier Racks	Each	1/12

### SHEET PAN RACK ACCESSORIES



Easily zippers on and off



ALRK-10-CV



ALRK-20-CV

### SHEET PAN RACK REPLACEMENT CASTERS

ITEM	DESCRIPTION	UOM	CASE
ALRC-5P	Caster for ALRK-3	Each	12
ALRC-5ST	Caster for ALRK & AWRK-series	Each	12
ALRC-5STK	Caster w/Brake for ALRK & AWRK-series	Each	12
ALRC-5R	Caster for ALRK-20R	Each	12
ALRC-5RK	Caster w/Brake for ALRK-20R	Each	12
ALRC-5H	Caster for ALRK-30BK, Heavyweight	Each	12
ALRC-5HK	Caster w/Brake for ALRK-30BK, Heavy-duty	Each	12
AWRC-5H	Caster for AWRK-20HBK, Heavy-duty	Each	12
AWRC-5HK	Caster w/Brake for AWRK-20HBK, Heavy-duty	Each	12
SRK-CT	Caster for SRK-36	Each	4/16
SRK-CTB	Caster w/ Brake for SRK-36	Each	4/16



ALRC-5P ALRC-5ST ALRC-5STK ALRC-5H

#### CASTER ITEM NUMBER

	ALRC-5P	ALRC-5ST	ALRC-5STK	ALRC-5E	ALRC-5EK	ALRC-5H	ALRC-5HK	ALRC-5K	ALRC-5RK	AWRC-5H	AWRC-5HK	SRK-CT	SRK-CTB
ALPR-26BK		2	2										
ALRK-10/20		4											
ALRK-10BK/15/20BK		2	2										
ALRK-20R				2	2			2	2				
ALRK-3	4												
ALRK-30BK						2	2						
ALRS-20BK		2	2										
ALZK-20BK		2	2										
AWPR-26BK		2	2										
AWRK-10/20		2	2										
AWRK-20HBK										2	2		
AWRS-20BK		2	2										
AWZK-20		2	2										
SRK-12/12D/36												2	2



ALRC-5RK ALRC-5HK AWRC-5HK SRK-CTB

### UNIVERSAL CASTERS, EXTRA HEAVY-DUTY

- ◆ Use with most appliances including ranges or walk-in refrigerators
- ◆ Polyurethane, skid-free - will not mark floors
- ◆ High-quality grease-resistant wheel
- ◆ Temperature range from 14°F to 212°F
- ◆ Wheel capacity: 220 lbs each
- ◆ CT-1 and CT-1B fit standard 1-5/8" or 1-1/2" tubing
- ◆ Two (2) pieces per set

ITEM	DESCRIPTION	PLATE SIZE	UOM	CASE
CT-1	Worktable Stem Set		Set	1/12
CT-1B	Worktable Stem Set w/Brake		Set	1/12
CT-23	Universal Plate Set	2-3/8" x 3-5/8"	Set	1/12
CT-23B	Universal Plate Set w/ Brake	2-3/8" x 3-5/8"	Set	1/12
CT-33	Universal Plate Set	3-1/2" x 3-1/2"	Set	1/12
CT-33B	Universal Plate Set w/ Brake	3-1/2" x 3-1/2"	Set	1/12
CT-44	Universal Plate Set	4" x 4"	Set	1/12
CT-44B	Universal Plate Set w/Brake	4" x 4"	Set	1/12

### UNIVERSAL CASTERS



CT-1 CT-1B CT-23 CT-23B

**5" DIA WHEEL**  
will raise height of equipment by 6"



CT-33 CT-33B CT-44 CT-44B

## RECTANGULAR PANS

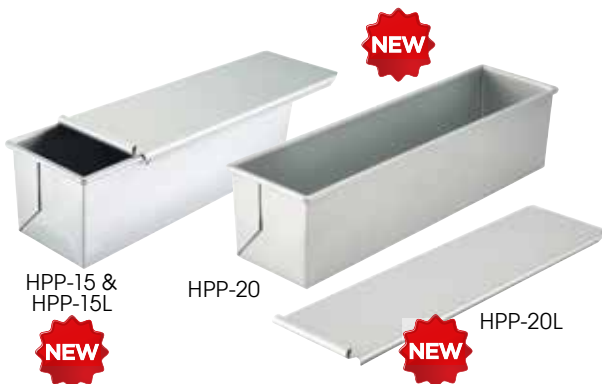

HPP-15 & HPP-15L

HPP-20

HPP-20L



HSCP-0808



PFOA FREE



HRCP-1812

PFOA FREE

HRCP-SERIES



ACP-0913

ACP-1212



HLF-100



PFOA FREE

HLF-SERIES



HLP-53

HLP-105

HLP-124

PFOA FREE

HLP-SERIES

## GLAZED ALUMINIZED STEEL PULLMAN PANS

- ◆ Non-stick coating, aluminized steel
- ◆ Durable, straight-sided folded construction
- ◆ Flat sliding lid holds in steam while baking for the perfect classic crust, great for slicing

ITEM	DESCRIPTION	SIZE	UOM	CASE
HPP-15	1-1/2 Lb	13" x 4" x 4"	Each	12
HPP-20	2 Lb	16" x 4" x 4"	Each	12
HPP-15L	Cover for HPP-15		Each	12
HPP-20L	Cover for HPP-20		Each	12



## ALUMINIZED STEEL CAKE PANS

- ◆ Quantum2® non-stick coating (double-coated)
- ◆ Withstands temperatures to 500°F (260°C)
- ◆ 24 gauge non-stick aluminized steel
- ◆ Wire-in reinforced rim with folded body construction
- ◆ PTFE/PFOA-free
- ◆ Dishwasher safe

ITEM	DESCRIPTION	SIZE	UOM	CASE
HRCP-1309	Rectangular	13" x 9" x 2-1/4"	Each	6
HRCP-1812	Rectangular	18" x 12" x 3"	Each	6
HSCP-0808	Square	8" x 8" x 2-1/4"	Each	6

## ALUMINUM CAKE PANS

- ◆ Straight sided, perfect for commercial baking
- ◆ Extended 1/2" flange for easy and safe handling
- ◆ Heavyweight for even heat distribution
- ◆ 1.6mm thickness, 16 gauge

ITEM	DESCRIPTION	SIZE	UOM	CASE
ACP-0913	Rectangular	9" x 13" x 2"	Each	6
ACP-1212	Square	12" x 12" x 2"	Each	6

## ALUMINIZED STEEL LOAF PANS

- ◆ Quantum2® non-stick coating (double-coated)
- ◆ Withstands temperatures up to 500°F (260°C)
- ◆ 24 gauge non-stick aluminized steel
- ◆ Wire-in reinforced rim with folded body construction
- ◆ PTFE/PFOA-free
- ◆ Dishwasher safe

ITEM	DESCRIPTION	SIZE	UOM	CASE
HLF-100	1 lb Loaf	8-1/2" x 4-1/2" x 2-3/4"	Each	6
HLF-150	1-1/2 lb Loaf	10" x 5" x 3"	Each	6

## ALUMINIZED STEEL LOAF PANS WITH SILICONE GLAZE

- ◆ Non-stick silicone coating
- ◆ Rolled top edge resists warping
- ◆ PTFE/PFOA-free

ITEM	DESCRIPTION	SIZE	UOM	CASE
HLP-53	3/8 lb Loaf	5-5/8" x 3-1/8" x 2-1/4"	Each	24
HLP-84	1 lb Loaf	8-1/2" x 4-1/2" x 2-3/4"	Each	12
HLP-94	1 lb Loaf	9" x 4-1/2" x 2-3/4"	Each	12
HLP-105	1-1/2 lb Loaf	10" x 5" x 3"	Each	12
HLP-124	1-1/2 lb Loaf	12-1/4" x 4-1/2" x 2-3/4"	Each	12



### GLAZED ALUMINUM BAGUETTE PANS

Serve up warm and fresh long rolls with the sturdy, commercial-grade baguette pans by Winco®. Each compartment cradles a baguette - up to six with the largest size pan - and the perforations allow air circulation for crispy crusts while the inside stays soft.

- ◆ 18" x 26" x 1"
- ◆ 16 gauge aluminum
- ◆ Non-stick silicone coating

ITEM	DESCRIPTION	UOM	CASE
ABPN-4	4 Slots	Each	6
ABPN-5	5 Slots	Each	6
ABPN-6	6 Slots	Each	6

Replaces ABP-Series



ABPN-6

### BREAD PANS

GLAZED



Perforations



ABPN-4

### GLAZED ALUMINUM SUB SANDWICH ROLL PAN

- ◆ 13" x 18" x 1"
- ◆ 16 gauge aluminum
- ◆ Non-stick silicone coating

ITEM	DESCRIPTION	UOM	CASE
ABPN-5H	5 Slots, 13" x 18" x 1"	Each	6

Replaces ABP-5W



GLAZED

ABPN-5H

### SILICONE BREAD FORM

- ◆ Non-stick silicone surface requires no oils or sprays
- ◆ Heats quickly and bakes evenly
- ◆ Ideal size for 12" long sandwich bread
- ◆ Dishwasher, oven, microwave and freezer safe
- ◆ Heat resistant up to 475°F (246°C)

ITEM	DESCRIPTION	SIZE	UOM	CASE
SBF-5K	5 Roll	18" x 13"	Each	12/144



SBF-5K

### SHEET CAKE MARKERS

A must-have for bakeries and buffets to achieve consistently sized square cuts.

- ◆ Stainless steel
- ◆ Full-size: 24-3/4"L x 16-3/4"W x 1"H

ITEM	DESCRIPTION	UOM	CASE
CKM-68	6 x 8, Marks (48) 3" x 3" Pieces	Each	24
CKM-69	6 x 9, Marks (56) 2-1/2" x 2-1/2" Pieces	Each	24
CKM-610	6 x 10, Marks (60) 2-1/4" x 2-1/2" Pieces	Each	24

### SHEET CAKE MARKERS

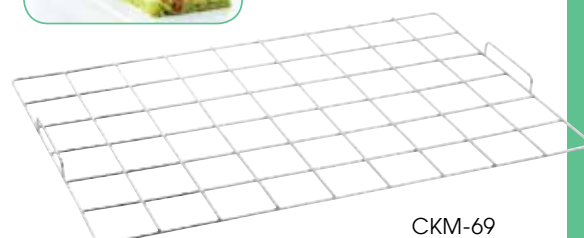

CKM-69

## SPRINGFORM PANS



HSP-042



HSP-123



HSP-SERIES



AASP-093



CPSF-9



### ALUMINIZED STEEL SPRINGFORM PANS

- ◆ Quantum2® non-stick coating (double-coated)
- ◆ Withstands temperatures up to 500°F (260°C)
- ◆ 24 gauge
- ◆ Dishwasher safe
- ◆ PTFE/PFOA-free

ITEM	DESCRIPTION	UOM	CASE
HSP-042	4"Dia x 1-1/2"H	Set	1/12
HSP-063	6"Dia x 2-3/4"H	Set	1/6
HSP-083	8"Dia x 2-3/4"H	Set	1/6
HSP-093	9"Dia x 2-3/4"H	Set	1/6
HSP-103	10"Dia x 2-3/4"H	Set	1/6
HSP-123	12"Dia x 2-3/4"H	Set	1/6



### HARD ANODIZED ALUMINUM SPRINGFORM PANS

- ◆ Bakes evenly, releases cleanly
- ◆ Oven safe up to 450°F (232°C)
- ◆ Hand wash recommended

ITEM	DESCRIPTION	UOM	CASE
AASP-063	6"Dia x 3"H	Each	1/36
AASP-093	9"Dia x 3"H	Each	1/24

### TIN SPRINGFORM PANS

- ◆ Withstands temperatures up to 482°F (250°C)

ITEM	DESCRIPTION	UOM	CASE
CPSF-8	8"Dia x 3"H	Each	12/36
CPSF-9	9-1/2"Dia x 3"H	Each	12/24
CPSF-10	10"Dia x 3"H	Each	12/24

## SPECIALTY CAKE PANS



CCP-10F



CCP-10A



NACP-10



NTHM-8



### FLUTED CAKE PAN

- ◆ Quantum2® non-stick aluminized carbon steel
- ◆ Ideal for making bundt cakes
- ◆ Dishwasher safe
- ◆ PTFE/PFOA-free

ITEM	DESCRIPTION	UOM	CASE
CCP-10F	10"Dia x 3-1/4"H	Each	1/6



### ANGEL FOOD CAKE PANS

- ◆ Non-stick coating
- ◆ Dishwasher safe
- ◆ PTFE/PFOA-free

ITEM	DESCRIPTION	UOM	CASE
CCP-10A	10"Dia x 5"H, Removable Bottom, Quantum2® Non-Stick, Aluminized Carbon Steel	Each	1/6
NACP-10	10"Dia x 4"H, Non-Stick Carbon Steel	Each	12/24



### TURK HEAD MOLD

- ◆ Non-stick carbon steel

ITEM	DESCRIPTION	UOM	CASE
NTHM-8	8-1/2"Dia x 4"H	Each	12/24

### DELUXE HARD ANODIZED ALUMINUM CAKE PANS

◆ 1.0mm thickness, 18 gauge

ITEM	DESCRIPTION	UOM	CASE
HAC-042	4"Dia x 2"H	Each	6/24
HAC-062	6"Dia x 2"H	Each	6/24
HAC-082	8"Dia x 2"H	Each	6/24
HAC-102	10"Dia x 2"H	Each	6/24
HAC-122	12"Dia x 2"H	Each	6/24
HAC-142	14"Dia x 2"H	Each	6/24
HAC-162	16"Dia x 2"H	Each	6/12

### ALUMINUM LAYER-CAKE PANS

ITEM	DESCRIPTION	UOM	CASE
ACP-032	3"Dia x 2"H	Each	12/48
ACP-042	4"Dia x 2"H	Each	12/48
ACP-062	6"Dia x 2"H	Each	6/36
ACP-063	6"Dia x 3"H	Each	6/36
ACP-082	8"Dia x 2"H	Each	6/36
ACP-083	8"Dia x 3"H	Each	6/36
ACP-092	9"Dia x 2"H	Each	6/36
ACP-093	9"Dia x 3"H	Each	6/36
ACP-102	10"Dia x 2"H	Each	6/36
ACP-103	10"Dia x 3"H	Each	6/36
ACP-122	12"Dia x 2"H	Each	6/36
ACP-123	12"Dia x 3"H	Each	6/24

### ALUMINUM PIE PLATES

ITEM	DESCRIPTION	UOM	CASE
APPL-8	8"Dia	Each	12/72
APPL-9	9"Dia	Each	12/72
APPL-10	10"Dia	Each	12/72
APPL-11	11"Dia	Each	12/72

### ALUMINIZED CARBON STEEL QUICHE/TART PANS

- ◆ Removable bottom eliminates damaging the crust by allowing for easy extraction of delicate molds
- ◆ Dishwasher safe

ITEM	DESCRIPTION	UOM	CASE
FQP-4	4"Dia x 3/4"H, 2-Pcs/Set	Set	1/6
FQP-8	8"Dia x 1-1/2"H	Each	1/6
FQP-10	10"Dia x 1-1/4"H	Each	1/6
FQP-12	12"Dia x 1-3/8"H	Each	1/6

### CAST ALUMINUM PIE/CAKE MARKERS

ITEM	DESCRIPTION	UOM	CASE
APM-06	6-Cut	Each	12/48
APM-07	7-Cut	Each	12/48
APM-08	8-Cut	Each	12/48
APM-10	10-Cut	Each	12/48
APM-12	12-Cut	Each	12/48

### STAINLESS STEEL PIE CUTTERS

ITEM	DESCRIPTION	UOM	CASE
SCU-6	6-Cut	Each	6/12
SCU-7	7-Cut	Each	6/12
SCU-8	8-Cut	Each	6/12

### DOUBLE-SIDED POLYPROPYLENE CAKE MARKERS

- ◆ Scores cakes up to 10" round for even slices

ITEM	DESCRIPTION	UOM	CASE
PCM-1012	10 & 12 Slice Marks	Each	12/24
PCM-1416	14 & 16 Slice Marks	Each	12/24

### WIRE CAKE LEVELER

*A must-have to make thinly layered cakes and tortes.*

- ◆ Adjustable stainless steel cutting wire with 10 notches
- ◆ Accommodates 10" diameter cakes that are 2" high

ITEM	DESCRIPTION	UOM	CASE
WLC-12	12" Bow	Each	24/144

### ROUND CAKE PANS



HAC-062



HAC-042

HAC-SERIES



ACP-032



ACP-063



ACP-042



APPL-11



APPL-8



FQP-10



FQP-SERIES



### MARKERS & CUTTERS

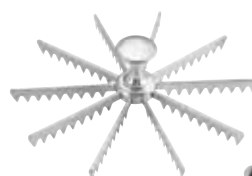

APM-10



SCU-6



PCM-1012

PCM-SERIES



WLC-12



## MINI LOAF PAN



PFOA FREE

HLF-8MN



## MINI LOAF PAN

Increase production and bake eight mini loaves, lasagnas or pastries at once! The essential, durable mini loaf pan is non-stick for easy release and even easier cleanup. Perfect for breads, mini meat loaves, lasagnas, quiche and pastries.

- ◆ Heavy-duty carbon steel with premium non-stick coating
- ◆ Makes eight (8) mini loaves
- ◆ Withstands temperatures up to 410°F (210°C)
- ◆ Dishwasher safe
- ◆ PTFE/PFOA-free

ITEM	DESCRIPTION	SIZE	CAPACITY	UOM	CASE
HLF-8MN	8 Cups	14" x 10-5/8"	5 Oz	Each	6

## MUFFIN PANS



PFOA FREE

AMF-24NS



PFOA FREE

AMF-12NS



AMF-12

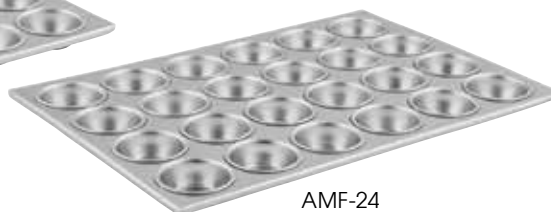

AMF-24

## REGULAR MUFFIN PANS

ITEM	DESCRIPTION	SIZE	CAPACITY	UOM	CASE
AMF-12	12 Cups, Alu	14" x 11"	3 Oz	Each	12/24
AMF-24	24 Cups, Alu	20-1/2" x 14"	3 Oz	Each	12
AMF-12NS	12 Cups, Non-stick Carbon Steel	15-1/2" x 11"	3 Oz	Each	24
AMF-24NS	24 Cups, Non-stick Heavy Alu	20-1/2" x 14"	3 Oz	Each	12



PFOA FREE

AMF-6NS

## JUMBO MUFFIN PAN

- ◆ Non-stick carbon steel

ITEM	DESCRIPTION	SIZE	CAPACITY	UOM	CASE
AMF-6NS	6 Cups	13" x 8-1/2"	7 Oz	Each	24

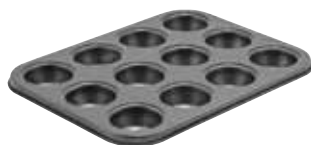

PFOA FREE

CMF-12M

## MINI MUFFIN PANS

- ◆ Non-stick carbon steel



ITEM	DESCRIPTION	SIZE	CAPACITY	UOM	CASE
CMF-12M	12 Cups, Quantum2® Non-Stick	10" x 7-3/4"	3/4 Oz	Each	1/6
AMF-24MNS	24 Cups	13-3/4" x 10-1/2"	1-1/2 Oz	Each	12

PFOA FREE

AMF-24MNS



**DELUXE HARD ANODIZED ALUMINUM COOKIE SHEET**

**COOKIE SHEET**

- ◆ Deluxe hard anodized aluminum
- ◆ Durable, non-stick, bakes evenly
- ◆ Withstands temperatures up to 450°F (232°C)
- ◆ Hand wash recommended
- ◆ PTFE/PFOA-free

ITEM	DESCRIPTION	SIZE	UOM	CASE
CS-2014	15 Gauge	20" x 14"	Each	4/16



CS-2014



**ICING/COOLING RACK**

- ◆ Built-in feet

ITEM	DESCRIPTION	SIZE	UOM	CASE
ICR-1725	Rectangular	16-1/4" x 25"	Each	6/12

**COOLING RACKS**

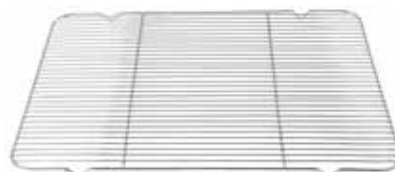

ICR-1725

**STEAMER RACKS**

- ◆ Built-in feet

ITEM	DESCRIPTION	SIZE	UOM	CASE
STR-10	Round	10-3/4"	Each	10
STR-13	Round	12-3/4"	Each	10
STR-15	Round	14-3/4"	Each	10
STR-18	Round	17-3/4"	Each	10



STR-15

**DOUGHNUT BASKET**

- ◆ Nickel-plated

ITEM	DESCRIPTION	UOM	CASE
DB-1218	12"L x 18"W x 2"H	Each	24

**DOUGHNUT BASKET**



DB-1218



## CAKE DECORATING



CKSR-12



NSF CKS-13C



CKS-13



NSF SDC-6



### REVOLVING CAKE DECORATING STAND

- ◆ Made of aluminum alloy with a smooth ball-bearing mechanism
- ◆ Cast iron base with silicone bottom for steady grip

ITEM	DESCRIPTION	UOM	CASE
CKSR-12	12"Dia	Each	6

### CAKE STAND & COVER

- ◆ Assembly required for cake stand and cover
- ◆ Covers available for full case purchase only

ITEM	DESCRIPTION	SIZE	UOM	CASE
CKS-13	Cake Stand, S/S	13" Dia	Set	6/12
CKS-13C	Cover for CKS-13, Plastic, NSF	12" Dia	Each	6



### STAINLESS STEEL TRIANGLE DECORATING COMBS

- ◆ 1.0mm thickness
- ◆ 3 different jagged teeth edges on each piece
- ◆ Each pack contains six (6) pieces
- ◆ NSF Listed

ITEM	DESCRIPTION	UOM	CASE
SDC-6	Fine, Medium, and Coarse in One Piece	Pack	12/48

## SPATULAS



TWPO-7

TWPS-7

NSF TWPO & TWPS-SERIES



TKPO-7

TKPS-7

NSF TKPO & TKPS-SERIES



TOS-7

TNS-7

- ◆ Stainless steel
- ◆ Satin finish
- ◆ NSF listed



### WHITE ERGO HANDLE

- ◆ Dishwasher safe

ITEM	DESCRIPTION	BLADE	UOM	CASE
TWPO-4	Offset Spatula*	3-1/2" x 3/4"	Each	24/288
TWPO-7	Offset Spatula*	6-1/2" x 1-5/16"	Each	12/144
TWPO-9	Offset Spatula*	8-1/2" x 1-1/2"	Each	12/144
TWPS-4	Bakery Spatula	4" x 3/4"	Each	24/288
TWPS-7	Bakery Spatula	7-15/16" x 1-1/4"	Each	12/144
TWPS-9	Bakery Spatula	10" x 1-3/8"	Each	12/72

\*Measurement reflects blade size not including offset



### BLACK ERGO HANDLE

- ◆ Dishwasher safe

ITEM	DESCRIPTION	BLADE	UOM	CASE
TKPO-4	Offset Spatula*	3-1/2" x 3/4"	Each	24/288
TKPO-7	Offset Spatula*	6-1/2" x 1-5/16"	Each	12/144
TKPO-9	Offset Spatula*	8-1/2" x 1-1/2"	Each	12/144
TKPS-4	Bakery Spatula	4" x 3/4"	Each	24/288
TKPS-7	Bakery Spatula	7-15/16" x 1-1/4"	Each	12/144
TKPS-9	Bakery Spatula	10" x 1-3/8"	Each	12/144

\*Measurement reflects blade size not including offset

### WOODEN HANDLE SPATULAS

ITEM	DESCRIPTION	BLADE	UOM	CASE
TNS-4	Bakery Spatula	4" x 3/4"	Each	24/288
TNS-7	Bakery Spatula	7-15/16" x 1-1/4"	Each	12/144
TNS-9	Bakery Spatula	10" x 1-3/8"	Each	12/72
TOS-4	Spatula Offset	3-1/2" x 3/4"	Each	24/288
TOS-7	Spatula Offset	6-1/2" x 1-5/16"	Each	12/144
TOS-9	Spatula Offset	8-1/2" x 1-1/2"	Each	12/72

\*Measurement reflects blade size not including offset

### CAKE DECORATING TIP SETS

Create delicate and pretty confections with these decorating tips made of rust-resistant stainless steel. Decorating tip sets come in a convenient storage box. The 26 and 52 piece sets include a standard coupler and metal flower nail.

ITEM	DESCRIPTION	UOM	CASE
CDT-24	24-Pc Set	Set	60
CDT-26	26-Pc Set	Set	12/48
CDT-52	52-Pc Set	Set	6/24



Convenient storage tray



CDT-52

### DECORATING TIP SETS



CDT-26



CDT-24

### CANVAS PASTRY BAG

◆ Polyurethane plastic-coated interior

ITEM	DESCRIPTION	UOM	CASE
PBC-12	12"	Each	12/576
PBC-14	14"	Each	12/576
PBC-16	16"	Each	12/576
PBC-18	18"	Each	12/576
PBC-21	21"	Each	12/576
PBC-24	24"	Each	12/288

### PASTRY BAGS



CDTC-2



PBC-16

### PLASTIC COUPLINGS

ITEM	DESCRIPTION	UOM	CASE
CDTC-2	2-Pc Set	Set	12/360

### WHIPPED CREAM DISPENSER

Whip up freshly-made creams, rich mousse, syrups, sauces and more to top off inspired creations.

- ◆ Includes three (3) decorating tips to create unique dessert and beverage presentations, and a brush to easily clean them
- ◆ Capacity: 1 Pint (0.5L)
- ◆ Fits standard 8gm N2O cartridge (not included), and compatible with all brands of whipped cream chargers/ cartridges
- ◆ Durable aluminum bottle and stainless steel handle
- ◆ Hand-wash only

ITEM	DESCRIPTION	SIZE	UOM	CASE
CW-A05	Whipped Cream Dispenser with 3 Decorating Tips	3" Dia x 12"H	Each	1/12
CW-P	3 Tips With 1 Cleaning Brush		Set	1
CW-PG	Replacement Gasket, 3-Pcs/Pk		Pack	1

### WHIPPED CREAM DISPENSER

NEW



CW-A05

CARTRIDGE NOT INCLUDED

THREE (3) DECORATING TIPS

BPA FREE



COOKIE & PASTRY CUTTERS

Create sweet, delicate confections with these cookie and pastry cutters. Made of rust-resistant stainless steel and available solid or fluted, in assorted shapes and sizes from 1" to 3" dia.



CST-1



CST-2



CST-12



CST-22



COOKIE CUTTERS

ITEM	DESCRIPTION	SHAPE	UOM	CASE
CST-1	11-Pc Set, 1"H	Fluted Round	Set	12/48
CST-2	11-Pc Set, 1"H	Plain Round	Set	12/48
CST-12	11-Pc Set, 2"H	Fluted Round	Set	1/24
CST-22	11-Pc Set, 2"H	Plain Round	Set	1/24



PASTRY CUTTERS

ITEM	DESCRIPTION	SHAPE	UOM	CASE
CST-31	8-Pc Pastry Set	Butterflies	Set	12/60
CST-32	12-Pc Pastry Set	Shapes	Set	12/60
CST-33	6-Pc Pastry Set	Holiday	Set	12/60
CST-34	26-Pc Pastry Set	Letters	Set	12/48



CST-31



CST-32



CST-33



CST-34



CC-1



CC-2

DEEP COOKIE CUTTER

- ◆ Ideal for cutting dough for biscuits
- ◆ 2-1/2" deep cut

ITEM	DESCRIPTION	UOM	CASE
CC-1	3"Dia, S/S	Each	12/120

DOUGHNUT CUTTER

- ◆ 2-1/2" deep cut

ITEM	DESCRIPTION	UOM	CASE
CC-2	3"Dia, S/S	Each	12/120



**CULINARY PASTRY MOLDS**

Perfect for baking, freezing, cutting and forming, these ring molds are extremely versatile kitchen tools. Create attractive plate presentations by layering salads and grains, or bake individual cake and pastry portions without waste.

- ◆ Stainless steel
- ◆ Polished smooth to a brilliant mirror finish
- ◆ Dishwasher safe

ITEM	DESCRIPTION	UOM	CASE
SPM-21R	Round, 2"Dia x 1-3/4"H	Each	12/72
SPM-23R	Round, 2"Dia x 3"H	Each	12/72
SPM-31R	Round, 3"Dia x 1-3/4"H	Each	12/72
SPM-31O	Oval, 3"L x 1-3/8"H	Each	12/72
SPM-41O	Oval, 4"L x 1-3/8"H	Each	12/72
SPM-22S	Square, 2"L x 2"W x 2"H	Each	12/72
SPM-275S	Square, 2-3/4"L x 2-3/4"W x 1-3/4"H	Each	12/72
SPM-211T	Rectangular, 2-1/2"L x 1-3/4"W x 1-3/4"H	Each	12/72



**PASTRY MOLDS**



SPM-23R

SPM-31R

SPM-21R



SPM-31O

SPM-41O



SPM-211T

SPM-275S

SPM-22S

## DOUGH PREPARATION



ALDP-SERIES

## DOUGH RETARDING/PROOFING PANS & COVERS

- ◆ Stackable for easy storage
- ◆ Aluminum

ITEM	DESCRIPTION	UOM	CASE
ALDP-48	48 Oz, 7-7/8"Dia x 3"H	Each	12/24
ALDP-48C	Cover for ALDP-48	Each	120
ALDP-96	96 Oz, 8-3/4"Dia x 3"H	Each	12/24
ALDP-96C	Cover for ALDP-96	Each	120

## DOUGH BOXES & COVER



IMPROVED STRUCTURE

## DOUGH BOXES & COVER

- ◆ Boxes stack tight to maintain freshness of contents
- ◆ Great for storing and proofing dough
- ◆ Reinforced structure resists breakage/bending over time
- ◆ Made of durable polypropylene
- ◆ BPA-free

ITEM	DESCRIPTION	UOM	CASE
PL-3N	25-5/8"L x 18"W x 3-1/4"H	Each	6
PL-6N	25-1/2"L x 17-1/2"W x 6"H	Each	3
PL-36NC	Cover	Each	12



Stackable



Reinforced edges & corners

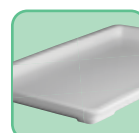

Lid can be used as tray



Seamless fit for fresh storage

## DOUGH SCRAPERS



## DOUGH SCRAPERS

- ◆ Stainless steel

ITEM	DESCRIPTION	BLADE	UOM	CASE
DSC-1	Steel Handle	5-1/4" x 4-1/4"	Each	12/48
DSC-2	Plastic Handle, NSF	6" x 3"	Each	12/72
DSC-2W	Plastic Handle, NSF	6" x 3"	Each	12/72
DSC-3	Wooden Handle	6" x 3"	Each	12/72



SEE PAGE 295 FOR MORE OF THE ALLERGEN-FREE LINE

Allergen Free

## ALLERGEN-FREE DOUGH SCRAPERS

Solve the challenges of maintaining an allergen-aware kitchen! Improve customer dining experiences while raising the bar for food safety. Prevent cross-contaminating allergens with this extensive line of Allergen-Free tools by Winco®. Whether it's gluten, nuts or more, use this stand-out purple color to designate these dough scrapers as allergen-free.

ITEM	DESCRIPTION	SIZE	UOM	CASE
DSC-2P	Dough Scraper, S/S Blade	6" x 3"	Each	12/72
PDS-7P	Plastic Dough Scrapers, 6-Pcs/Pk	7-1/2" x 4-3/4"	Pack	24/48



## PLASTIC DOUGH SCRAPERS

- ◆ NSF listed

ITEM	DESCRIPTION	SIZE	UOM	CASE
PDS-7	Large, 6-Pcs/Pk	7-1/2" x 4-3/4"	Pack	24/48
PDS-5	Small, 12-Pcs/Pk	5-1/2" x 3-3/4"	Doz	21/42

### DOUGH DIVIDERS WITH ADJUSTABLE WHEELS

- ◆ Stainless steel wheels adjust width from 3/4" to about 4-3/8" apart for ADD-5 & to about 4-3/4" for ADD-6

ITEM	DESCRIPTION	UOM	CASE
ADD-5	5-Wheel	Each	36
ADD-6	6-Wheel	Each	36

### DOUGH ROLLER DOCKERS

- ◆ Stainless steel handle
- ◆ 8" Overall Length

ITEM	DESCRIPTION	UOM	CASE
RD-2	2-5/8"W Head	Each	1/24
RD-5	5"W Head	Each	1/24
RD-8	5"W Head, 8-Wheel	Each	1/24

### PLASTIC ROLLER DOCKERS

- ◆ 6 independently spinning wheels on the RD-4P
- ◆ Prevent bubbles from forming

ITEM	DESCRIPTION	UOM	CASE
RD-4P	4"W Head, Molded Ergonomic Handle	Each	1/24
RD-5P	5"W Head, Plastic Handle	Each	12/72

### DOUGH WHEELS/DOCKERS

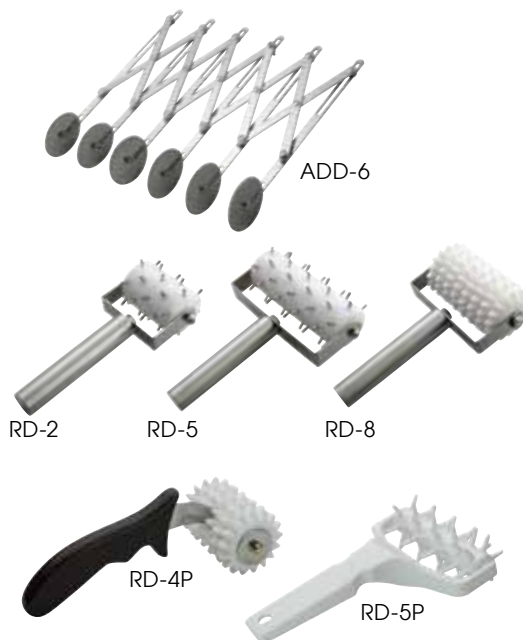

### ALUMINUM ROLLING PINS

ITEM	DESCRIPTION	UOM	CASE
ARP-13	13"L x 3-1/2"Dia	Each	1/6
ARP-15	15"L x 3-1/2"Dia	Each	1/6
ARP-18	18"L x 3-1/2"Dia	Each	1/6

### WOODEN ROLLING PINS

ITEM	DESCRIPTION	UOM	CASE
WRP-13	13"L x 2-3/4" Dia	Each	12
WRP-15	15"L x 2-3/4" Dia	Each	12
WRP-18	18"L x 2-3/4" Dia	Each	12

### FRENCH WOODEN ROLLING PIN

ITEM	DESCRIPTION	UOM	CASE
WRP-20F	20"L x 1-3/16"Dia, Tapered	Each	12/48

### ROLLING PINS



### DOUBLE PASTRY WHEEL

- ◆ Features 2 separate stainless steel blades, straight & fluted
- ◆ Ideal for ravioli, strudel, pastry dough
- ◆ Sturdy stainless steel blades with ergonomic plastic handle
- ◆ Safety guard for hand protection
- ◆ Hole in handle for convenient hanging
- ◆ Dishwasher safe

ITEM	DESCRIPTION	UOM	CASE
PPC-1D	Double Pastry Wheel	Each	12/144

### ECONOMY PASTRY BLENDER

ITEM	DESCRIPTION	UOM	CASE
PST-5B	5 Blades, S/S	Each	12/72



### PERFECT PIE BLENDER

*The Connoisseur pastry blender is faster, cleaner, easier, and more consistent than any other pastry utensil on the market today. The ergonomically designed Pastry Pro allows you to make perfect pastry in 60 seconds!*

- ◆ Patented stainless steel diamond shape cutting blades designed to cut through flour and butter
- ◆ Rubberized handle
- ◆ Dishwasher safe

ITEM	DESCRIPTION	UOM	CASE
PSTCO-7	7 Blades	Each	6/24

### PASTRY TOOLS

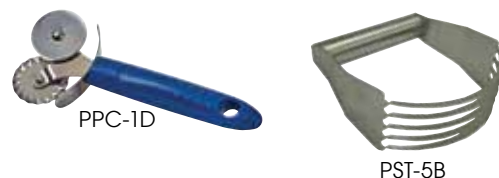

Patented S/S diamond shape cutting blades



## BATTER DISPENSERS



APCD-6



APCD-6R

### ALUMINUM PANCAKE DISPENSER

- ◆ Durable plunger ensures consistent amounts of batter every time
- ◆ Eight portion-control settings range from 1/2 oz to 8 oz
- ◆ 10 gauge high-grade aluminum body
- ◆ Long lasting parts prevent clogging and leaking

ITEM	DESCRIPTION	UOM	CASE
APCD-6	Pancake Dispenser	Each	1/6
APCD-6R	Rack for APCD-6	Each	12/48

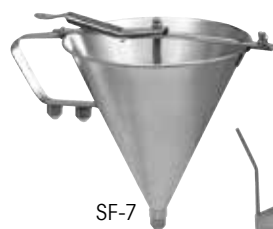

SF-7



SF-7 & SF-7R

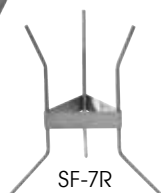

SF-7R

### CONFECTIONERY FUNNEL

- ◆ Use to dispense a smooth flow of fondant, syrup, or prepared creams
- ◆ Spring valve feature allows for easy control with single-handed operation
- ◆ Comes with 3 nozzles: 4mm, 5mm, 6mm
- ◆ Rack not included

ITEM	DESCRIPTION	UOM	CASE
SF-7	Funnel, S/S	Each	1/8
SF-7R	Rack for SF-7, S/S	Each	1/24

## SIFTERS



RFS-8



SIV-14

### ROTARY SIFTER

ITEM	DESCRIPTION	UOM	CASE
RFS-8	8 Cup, S/S	Each	1/12

### SIEVES

- ◆ Stainless steel #20 mesh

ITEM	DESCRIPTION (DIA X H)	UOM	CASE
SIV-10	10" x 3"	Each	1/6
SIV-12	12" x 3"	Each	1/6
SIV-14	14" x 3"	Each	1/6
SIV-16	16" x 3"	Each	1/6

## FUNNELS



SF-6



SF-6S



PF-32

### WIDE-MOUTH FUNNELS & REMOVABLE STRAINERS

- ◆ Stainless steel mirror finish for SF-5 and SF-6

ITEM	DESCRIPTION	UOM	CASE
SF-5	5" Funnel	Each	12/72
SF-6	5-3/4" Funnel	Each	12/72
SF-6S	Strainer for SF-5 and SF-6	Each	120/480

### PLASTIC FUNNELS

ITEM	DESCRIPTION	UOM	CASE
PF-8	8 Oz, 4"Dia	Each	6/324
PF-16	16 Oz, 5-1/4"Dia	Each	6/324
PF-32	32 Oz 6-1/4"Dia	Each	6/216

**STRAINER-SIFTER**

Give baked delicacies a flavorful finish with this 3 inch sifter. The fine mesh makes it possible to craft that light sprinkle of powdered sugar, cocoa, nutmeg, etc.

- ◆ Stainless steel

ITEM	DESCRIPTION	UOM	CASE
MS2K-3S	8"L x 1"H O.L., 3"Dia	Each	24/144

**STRAINER-SIFTER**



MS2K-3S

**POWDERED SUGAR DISPENSER**

- ◆ Stainless steel
- ◆ Also ideal for cocoa, nutmeg or cinnamon
- ◆ Includes plastic cap

ITEM	DESCRIPTION	UOM	CASE
SSD-10	10 Oz	Each	12/60

**DREDGES**



SSD-10



Includes plastic cap

**ADJUSTABLE SHAKER DREDGE**

- ◆ 18/8 stainless steel mirror finish
- ◆ Features a three-way adjustable top with small, medium and large holes

ITEM	DESCRIPTION	UOM	CASE
DRG-8P	8 Oz	Each	12/96



DRG-8P



DRG-8P Adjustable Tap

**STAINLESS STEEL DREDGES**

ITEM	DESCRIPTION	UOM	CASE
DRG-10	10 Oz w/Handle	Each	12/144
DRG-10H	10 Oz w/o Handle	Each	12/144
DRG-22H	22 Oz w/o Handle	Each	12/48



DRG-10



DRG-10H



DRG-22H

**ALUMINUM DREDGES**

ITEM	DESCRIPTION	UOM	CASE
ADRG-10	10 Oz w/ Handle	Each	12/144
ADRG-10H	10 Oz w/o Handle	Each	12/144



ADRG-10



ADRG-10H

**PLASTIC DREDGE SETS**

- ◆ 10 oz polycarbonate dredge sets with snap-on lids
- ◆ NSF listed

ITEM	DESCRIPTION	UOM	CASE
PDG-10	10 Oz w/3 Clear Lids (S, M, L)	Set	1/48
PDG-10AC	10 Oz w/4 Colored Lids	Set	1/48
PDG-10CS	10 Oz w/Clear S Lid	Set	12/48
PDG-10CM	10 Oz w/Clear M Lid	Set	12/48
PDG-10CL	10 Oz w/Clear L Lid	Set	12/48
PDG-10CXL	10 Oz w/Clear XL Lid	Set	12/48
PDG-10B	10 Oz w/Beige Lid	Set	12/48
PDG-10G	10 Oz w/Green Lid	Set	12/48
PDG-10R	10 Oz w/Rose Lid	Set	12/48
PDG-10Y	10 Oz w/Yellow Lid	Set	12/48



PDG-10AC

PDG-10

PDG-SERIES NSF

**PLASTIC COLORED DREDGE LIDS**

- ◆ Fits both PDG-10 and PDG-10AC dredges
- ◆ Each pack contains six (6) pieces

ITEM	DESCRIPTION	UOM	CASE
PDG-BL	Beige Lids	Pack	72/144
PDG-GL	Green Lids	Pack	72/144
PDG-RL	Rose Lids	Pack	72/144
PDG-YL	Yellow Lids	Pack	72/144



PDG-SERIES COLORED LIDS

**PASTRY BRUSHES**



NB-10R

NB-15

NB-20

NB-30

NB-40

NB-20HK

NB-30HK

WBRP-20H

WBRP-30H



WFB-SERIES



WBR-SERIES



PBST-1.5

**BPA FREE**



OM-13

**NYLON BRISTLE PASTRY BRUSHES**

Made for long lasting use, nylon bristle pastry brushes are versatile enough to use for basting meats or glazing pastries. Available in a variety of sizes to suit every need.

- ◆ Bristles are epoxy-set to ferrules which prevent bacteria from collecting
- ◆ Bristles are heat-resistant up to 300°F (150°C)
- ◆ One-piece smooth-finish plastic handle for easy cleaning
- ◆ Dishwasher safe

ITEM	DESCRIPTION	SIZE	UOM	CASE
NB-10R	Round Brush	1" Dia	Each	12/240
NB-15	Flat Brush	1-1/2"	Each	12/240
NB-20	Flat Brush	2"	Each	12/240
NB-20HK	Concave w/Hook	2"	Each	12/120
NB-30	Flat Brush	3"	Each	12/120
NB-30HK	Concave w/Hook	3"	Each	12/120
NB-40	Flat Brush	4"	Each	12/120

**BOAR BRISTLE PASTRY BRUSHES**

Made for heavy or thick sauces, boar bristle pastry brushes are ideal for basting meat and poultry.

- ◆ Concave natural boar bristles with plastic hook handle
- ◆ Bristles are heat-resistant up to 500°F (260°C)
- ◆ Hook allows the brush to rest on the edge of a pot or pan

ITEM	DESCRIPTION	SIZE	UOM	CASE
WBRP-20H	Concave w/Hook	2"	Each	12/72
WBRP-30H	Concave w/Hook	3"	Each	12/72

**PASTRY/BASTING BRUSHES**

- ◆ Natural boar hair bristles
- ◆ WFB: wooden handle with plastic ferrules
- ◆ WBR: wooden handle with metal ferrules

ITEM	DESCRIPTION	SIZE	UOM	CASE
WFB-10	Flat Brush	1"	Each	12/144
WFB-10R	Round Brush	1" Dia	Each	12/144
WFB-15	Flat Brush	1-1/2"	Each	12/144
WFB-20	Flat Brush	2"	Each	12/144
WFB-30	Flat Brush	3"	Each	12/72
WFB-40	Flat Brush	4"	Each	12/72
WBR-10	Flat Pastry Brush	1"	Each	12/600
WBR-15	Flat Pastry Brush	1-1/2"	Each	12/600
WBR-20	Flat Pastry Brush	2"	Each	12/240
WBR-25	Flat Pastry Brush	2-1/2"	Each	12/240
WBR-30	Flat Pastry Brush	3"	Each	12/240
WBR-40	Flat Pastry Brush	4"	Each	12/240

**PLASTIC BASTER**

- ◆ 1.5 oz capacity with rubber bulb
- ◆ BPA-free

ITEM	DESCRIPTION	UOM	CASE
PBST-1.5	7-1/2" Tube, 11" O.L.	Each	12/72

**OIL MOP**

ITEM	DESCRIPTION	UOM	CASE
OM-13	13" O.L.	Each	12/96

**SILICONE BRUSH**

The perfect tool for brushing on marinades, oil or butter onto meats, fish or breads! This silicone brush won't scratch foods and is non-stick friendly.

- ◆ 100% silicone exterior; stainless steel interior
- ◆ Heat-resistant up to 428°F (220°C)
- ◆ Dishwasher safe for quick, easy cleanup
- ◆ BPA-free

ITEM	DESCRIPTION	UOM	CASE
SB-175R	1-3/4" W	Each	24/144



SB-175R **BPA FREE**

**NEOPRENE NON-SLIP OVEN MITTS**

- ◆ 100% neoprene shell, 100% cotton fill and lining
- ◆ Heat resistant up to 500°F (260°C)
- ◆ Stain and water resistant
- ◆ Hanging loop for easy storage
- ◆ Hand wash, wipe clean

ITEM	DESCRIPTION	UOM	CASE
OMNP-15	15"	Each	12/48
OMNP-17	17"	Each	12/48

**OVEN MITTS & POT HOLDERS**

**NEW**

AVAILABLE IN JULY 2020



OMNP-SERIES

**FLAME RETARDANT OVEN MITTS**

- ◆ Offers protection up to 400°F (205°C)
- ◆ OMF-24 is extra-long for full arm-length protection
- ◆ 100% cotton
- ◆ Spot clean only

ITEM	DESCRIPTION	UOM	CASE
OMF-13	13"	Each	12/72
OMF-15	15"	Each	12/72
OMF-17	17"	Each	12/72
OMF-24	24"	Each	12/72



OMF-SERIES

**SILICONE COATED OVEN MITTS**

- ◆ Offers protection in (cold) freezer or (hot) oven
- ◆ Temperature range of 0°F (17°C) up to 200°F (93°C)
- ◆ 100% cotton with non-stick silicone outer coating
- ◆ Spot clean only

ITEM	DESCRIPTION	UOM	CASE
OMS-13	13"	Each	12/72
OMS-15	15"	Each	12/72
OMS-17	17"	Each	12/72



OMS-SERIES



OMT-SERIES

**TERRY CLOTH OVEN MITTS**

- ◆ Heat-resistant up to 600°F (315°C)
- ◆ 100% cotton with silicone lining
- ◆ Machine washable

ITEM	DESCRIPTION	UOM	CASE
OMT-13	13"	Each	12/72
OMT-17	17"	Each	12/72



PH-8N

**NEW**

AVAILABLE IN JULY 2020

**POT HOLDERS**

ITEM	DESCRIPTION	SIZE	UOM	CASE
PH-8B	Green Side Fire Retardant, Other Side Terrycloth	8" x 8"	Doz	1/25
PH-8N	Black Neoprene, Stain & Water Resistant	8" x 8"	Each	12/72
PH-8S	Gray Cotton	8" x 8"	Doz	1/25
PH-9W	White Terrycloth w/ Pocket	8-1/2" x 9-1/2"	Doz	1/15



PH-9W



PH-8S



PH-8B

SCRAPERS

SEE PAGE 295 FOR MORE OF THE ALLERGEN-FREE LINE



NSF



PSH-16P

BPA FREE

PSH-SERIES



IMPROVED DESIGN

PSH-series features raised ridges on the blade



NSF



BPA FREE

PSH-SERIES



BPA FREE

PSG-SERIES



BPA FREE

PSD-SERIES



BPA FREE

PSGE-SERIES



NSF

BPA FREE

PSC-SERIES

ALLERGEN-FREE COLOR CODED SCRAPER

Solve the challenges of maintaining an allergen-aware kitchen! Improve customer dining experiences while raising the bar for food safety. Prevent cross-contaminating allergens with the extensive line of Allergen-Free tools by Winco®. Whether it's gluten, nuts or more, use this stand-out purple color to designate these scrapers as allergen-free.

- ◆ Features raised ridges to rest on, preventing messy counters
- ◆ Heat-resistant up to 600°F (315°C)
- ◆ NSF listed
- ◆ BPA-free

ITEM	DESCRIPTION	UOM	CASE
PSH-10P	10-1/2"	Each	24/144
PSH-14P	14"	Each	24/144
PSH-16P	16-1/4"	Each	24/144

SILICONE SCRAPERS

- ◆ Features raised ridges to rest on, preventing messy counters
- ◆ Heat-resistant up to 600°F (315°C)
- ◆ NSF listed
- ◆ BPA-free

ITEM	DESCRIPTION	UOM	CASE
PSH-10	10-1/2"	Each	24/144
PSH-14	14"	Each	24/144
PSH-16	16-1/4"	Each	24/144

BOWL-SHAPED SILICONE SCRAPERS

- ◆ Heat-resistant up to 500°F (260°C)
- ◆ BPA-free

ITEM	DESCRIPTION	UOM	CASE
PSG-10	10"	Each	12/120
PSG-14	14"	Each	12/120
PSG-16	16"	Each	12/120

ECONOMY SILICONE SCRAPERS

- ◆ Heat-resistant up to 500°F (260°C)
- ◆ BPA-free

ITEM	DESCRIPTION	UOM	CASE
PSD-10	10"	Each	12/120
PSD-14	14"	Each	12/120
PSD-16	16"	Each	12/120

BOWL-SHAPED PLASTIC SCRAPERS

- ◆ BPA-free

ITEM	DESCRIPTION	UOM	CASE
PSGE-10	10"	Each	12/120
PSGE-14	14"	Each	12/72
PSGE-16	16"	Each	12/36

PLASTIC SCRAPERS

- ◆ NSF listed
- ◆ BPA-free

ITEM	DESCRIPTION	UOM	CASE
PSC-10	10"	Each	24/360
PSC-14	14"	Each	12/288
PSC-16	16"	Each	12/288





**TIMERS**

ITEM	DESCRIPTION	TIME	UOM	CASE
TIM-78	Mechanical Timer	60 min	Each	12/36
TIM-85D	LCD Digital Timer w/20 min Stopper	20 hrs	Each	12/144

**TIMERS**



TIM-85D



TIM-78

**STAINLESS STEEL MIXING PADDLES**

ITEM	DESCRIPTION	UOM	CASE
MPD-24	24"	Each	12
MPD-36	36"	Each	12
MPD-48	48"	Each	12
MPD-60	60"	Each	12

**PADDLES & SPOONS**



MPD-24



MPD-36

**WOODEN STIRRING PADDLES**

ITEM	DESCRIPTION	UOM	CASE
WSP-18	18"	Each	12/36
WSP-24	24"	Each	12/36
WSP-36	36"	Each	12/36
WSP-48	48"	Each	12/36



WSP-24

**HIGH-HEAT NYLON MIXING PADDLES**

Mix, fold or spread anything from icing to batters with this nylon mixing paddle. The stain-resistant, sturdy one-piece construction is resistant to high temperatures, making it ideal for melting chocolate on hot stove tops.

◆ High temperature nylon is heat-resistant up to 400°F (204°C)



NSP-10W

ITEM	DESCRIPTION	UOM	CASE
NSP-10W	10"	Each	12/120
NSP-14W	14"	Each	12/120
NSP-20W	20"	Each	12/120

NSP-SERIES



**HIGH HEAT NYLON SPOONS**

◆ One-piece construction, ideal for non-stick cookware  
 ◆ Stain resistant; heat-resistant up to 400°F (204°C)

ITEM	DESCRIPTION	UOM	CASE
NS-12B	12", Blue	Each	24/144
NS-12R	12", Red	Each	24/144
NS-12T	12", Tan	Each	24/144
NS-12W	12", Off-white	Each	24/144
NS-15B	15", Blue	Each	24/72
NS-15R	15", Red	Each	24/72
NS-15T	15", Tan	Each	24/72
NS-15W	15", Off-white	Each	24/72



NS-15B



NS-15R



NS-15T



NS-15W

NS-SERIES



**WOODEN SPOONS**

ITEM	DESCRIPTION	UOM	CASE
WWP-12	12"	Doz	1/8
WWP-14	14"	Doz	1/8
WWP-16	16"	Doz	1/8
WWP-18	18"	Doz	1/8



WWP-SERIES

## MEASURING CUPS & SPOONS

**NSF** PMCP-SERIES



**NSF** PMU-SERIES



- DELUXE POLYCARBONATE MEASURING CUPS**
- ◆ Molded one-piece break-resistant polycarbonate; heat-resistant up to 210°F (98°C)
  - ◆ Raised external markings in both quarts (red letters) and liters (blue letters)
  - ◆ Tapered open handle for a secure grip; stackable
  - ◆ Dishwasher safe

ITEM	DESCRIPTION	UOM	CASE
PMCP-25	1 Cup	Each	6/72
PMCP-50	1 Pint	Each	6/72
PMCP-100	1 Qt	Each	6/36
PMCP-200	2 Qt	Each	6/36
PMCP-400	4 Qt	Each	6/24
PMCP-5SET	Complete 5-Pc Set	Set	1/6

### POLYCARBONATE MEASURING CUPS

- ◆ Durable polycarbonate w/raised graduation markings
- ◆ NSF listed

ITEM	DESCRIPTION	UOM	CASE
PMU-25	1 Cup	Each	36
PMU-50	1 Pint	Each	36
PMU-100	1 Qt	Each	36
PMU-200	2 Qt	Each	36
PMU-400	4 Qt	Each	12



MSL-5S



MSL-11



### MINI MEASURING LADLES

*Easily portion and serve smaller quantities with mini ladles in varying capacities.*

- ◆ Ideal for either measuring or serving small quantities
- ◆ Durable 18/8 stainless steel construction
- ◆ Capacity stamped on each handle

ITEM	DESCRIPTION	UOM	CASE
MSL-5S	5-Pc Set: 1/8 Tsp, 1/4 Tsp, 1/2 Tsp, 1 Tsp, 1 Tbsp	Set	12/72
MSL-11	3/4 Tbsp	Each	60/300

### STAINLESS STEEL MEASURING SPOON SETS

- ◆ Sets includes: 1/4 Tsp, 1/2 Tsp, 1 Tsp, 1 Tbsp

ITEM	DESCRIPTION	UOM	CASE
MSP-4P	4-Pc Set	Set	12/288
MSPD-4X	Deluxe 4-Pc Set	Set	24/240



MSP-4P



MSPD-4X

### PLASTIC MEASURING SPOON SET

- ◆ Set includes: 1/4 Tsp, 1/2 Tsp, 1 Tsp, 1 Tbsp
- ◆ BPA-free

ITEM	DESCRIPTION	UOM	CASE
MSPP-4	4-Pc Set	Set	12/216



**BPA FREE**

MSPP-4



**BPA FREE**

MCPP-4

### PLASTIC MEASURING CUP SET

- ◆ Set includes: 1/4 Cup, 1/3 Cup, 1/2 Cup, 1 Cup
- ◆ BPA-free

ITEM	DESCRIPTION	UOM	CASE
MCPP-4	4-Pc Set	Set	12/72

### STAINLESS STEEL MEASURING CUP SET

- ◆ Set includes: 1/4 Cup, 1/3 Cup, 1/2 Cup, 1 Cup

ITEM	DESCRIPTION	UOM	CASE
MCP-4P	4-Pc Set	Set	12/48



MCP-4P



AM-2

### ALUMINUM MEASURING CUPS

ITEM	DESCRIPTION	UOM	CASE
AM-05	1/2 Qt	Each	1/48
AM-1	1 Qt	Each	1/36
AM-2	2 Qt	Each	1/36
AM-4	4 Qt	Each	1/24

## PIZZA PANS



PIZZA PANS  
ARE IN STOCK,  
CUSTOM ORDER  
NOT REQUIRED

### WIDE-RIM ALUMINUM PIZZA PANS

- ◆ All-purpose wide-rim pan allows for baking and serving straight out of the oven
- ◆ Aluminum

ITEM	DESCRIPTION	UOM	CASE
APZT-7	7"	Each	36/72
APZT-8	8"	Each	36/144
APZT-9	9"	Each	36/72
APZT-10	10"	Each	36/72
APZT-11	11"	Each	36/72
APZT-12	12"	Each	36/72
APZT-13	13"	Each	36/72
APZT-14	14"	Each	24/48
APZT-15	15"	Each	24/48
APZT-16	16"	Each	24/48
APZT-17	17"	Each	12/36
APZT-18	18"	Each	12/36
APZT-19	19"	Each	12/24
APZT-20	20"	Each	12/24



APZT-SERIES

### COUPE-STYLE ALUMINUM PIZZA PANS

- ◆ Ideal for baking and serving thin-crust pizzas
- ◆ Aluminum

ITEM	DESCRIPTION	UOM	CASE
APZC-8	8"	Each	36/144
APZC-9	9"	Each	36/144
APZC-10	10"	Each	36/72
APZC-11	11"	Each	36/72
APZC-12	12"	Each	36/72
APZC-13	13"	Each	36/72
APZC-14	14"	Each	24/48
APZC-15	15"	Each	24/48
APZC-16	16"	Each	24/48
APZC-18	18"	Each	12/36



APZC-SERIES

### STACKABLE ALUMINUM PIZZA PANS

- ◆ 1-1/2" pan depth
- ◆ 1" clearance between pans when stacked

ITEM	DESCRIPTION	UOM	CASE
APZK-0615	6"	Each	6/24
APZK-0815	8"	Each	6/24
APZK-1015	10"	Each	6/24
APZK-1215	12"	Each	6/12
APZK-1415	14"	Each	6/12
APZK-1615	16"	Each	6/12



APZK-1615



Stackable

## PIZZA PANS



SPP-1218

SPP-1616



Durable  
heavyweight  
cold-rolled  
steel



HAC-162

SEE PAGE 249  
FOR MORE PAN  
OPTIONS

PFOA  
FREE

HAC-SERIES



### COLD-ROLLED STEEL SICILIAN PIZZA PANS

A must-have for making traditional thick-and-chewy Sicilian pizzas.

- ◆ Tapered design and fully nesting
- ◆ Non-stick coating provides an even-heat transfer
- ◆ Durable heavyweight cold-rolled steel
- ◆ Withstands temperatures up to 500°F (260°C)

ITEM	DESCRIPTION	UOM	CASE
SPP-1218	12"L x 18"W x 1"H	Each	12
SPP-1616	16"L x 16"W x 1"H	Each	12



### HARD ANODIZED ALUMINUM DEEP DISH PANS

- ◆ Great for deep dish pizzas
- ◆ 1.0mm, 18 gauge
- ◆ PTFE/PFOA-free

ITEM	DESCRIPTION	UOM	CASE
HAC-082	8"Dia x 2"H	Each	6/24
HAC-102	10"Dia x 2"H	Each	6/24
HAC-122	12"Dia x 2"H	Each	6/24
HAC-142	14"Dia x 2"H	Each	6/24
HAC-162	16"Dia x 2"H	Each	6/12

## PIZZA SCREENS

PIZZA PANS  
ARE IN STOCK,  
CUSTOM ORDER  
NOT REQUIRED



APZS-7

### ALUMINUM PIZZA SCREENS

- ◆ Mesh bottom helps transfer heat to create a crispier crust

ITEM	DESCRIPTION	UOM	CASE
APZS-7	7"	Each	12/120
APZS-8	8"	Each	12/120
APZS-9	9"	Each	12/120
APZS-10	10"	Each	12/120
APZS-11	11"	Each	12/120
APZS-12	12"	Each	12/120
APZS-13	13"	Each	12/120
APZS-14	14"	Each	12/120
APZS-15	15"	Each	12/120
APZS-16	16"	Each	12/120
APZS-17	17"	Each	12/120
APZS-18	18"	Each	12/60
APZS-19	19"	Each	12/60
APZS-20	20"	Each	12/60

## PIZZA PAN STAND & RACK



NON-SLIP  
GRIP

APZT-789

IMPROVED  
STRUCTURE

APZT-1015



### PIZZA PAN TABLETOP STAND

- ◆ Simple, attractive stand raises 6-1/2" above surface
- ◆ Ideal for tabletop with limited space

ITEM	DESCRIPTION	UOM	CASE
APZT-789	Chrome Plated Steel	Each	20

### PIZZA PAN TABLETOP RACK

- ◆ 1-5/8" spacing between each level
- ◆ Overall height is 27"
- ◆ Base measures 12" x 12"

ITEM	DESCRIPTION	UOM	CASE
APZT-1015	15 Tiers, Welded	Each	2

### PIZZA PAN GRIPPERS

ITEM	DESCRIPTION	UOM	CASE
PPG-8	Gripper for Deep Pizza Pans	Each	12/60
PPG-8A	Heavy-duty Cast Aluminum Gripper	Each	12/48
PPG-8S	Gripper for Shallow Pizza Pans	Each	6/60



### PIZZA PAN GRIPPERS

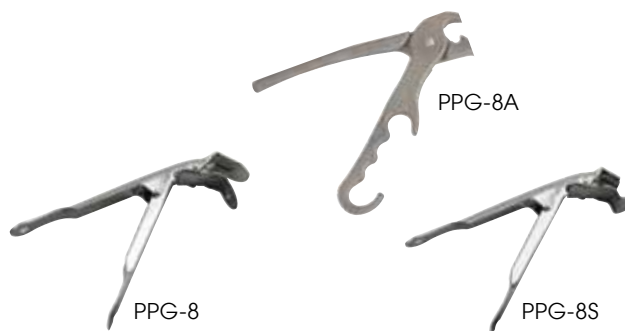

### PIZZA BUBBLE POPPERS

Say goodbye to unsightly pizza bubbles with pizza poppers, the long-reach tools that deflate dough bubbles while pizza is cooking in the oven.

ITEM	DESCRIPTION	O.L.	UOM	CASE
PZP-32	Aluminum	32"	Each	24/48
PZP-38WH	Wooden Handle	38"	Each	12/24

### PIZZA BUBBLE POPPERS



### 26-TIER MOBILE PIZZA PAN RACK WITH BRAKES

Each tier features an extended ledge to accommodate round or square pizza pans.

- ◆ 26-tier sturdy aluminum construction
- ◆ Designed to hold and transport 17" & 19" dia round pizza pans and 16" & 17" square Sicilian pizza pans
- ◆ 5" dia, full-swivel casters; two (2) with brake
- ◆ Capacity: up to 650 Lbs
- ◆ 2" spacing between each tier
- ◆ 4-1/8" wide ledge design
- ◆ Ships either welded or knocked down
- ◆ Fully assembled dimensions: 22"L x 20"D x 62-1/2"H
- ◆ NSF listed

### ALUMINUM 26-TIER PIZZA PAN RACK



ITEM	DESCRIPTION	UOM	CASE
AWPR-26BK	26-Tier, Welded	Each	1
ALPR-26BK	26-Tier, Knocked Down	Each	1
ALRC-5ST	Caster for ALZK & AWZK-series	Each	12
ALRC-5STK	Caster w/Brake for ALZK & AWZK-series	Each	12



ALRC-5STK  
5" caster with brake

ALPR-26BK NSF  
AWPR-26BK



## PEELS

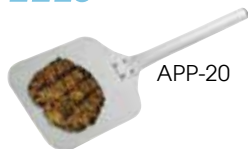

APP-20



APP-10M



APP-18M



APP-18L



WPP-1222



WPP-1436



WPP-2042

## ALUMINUM PIZZA/BURGER PEEL

- ◆ 14 gauge, 1.6mm thick
- ◆ 11"L handle

ITEM	DESCRIPTION	O.L.	UOM	CASE
APP-20	6-3/4" x 9" Blade	20"	Each	12/48

## ALUMINUM PIZZA PEELS

- ◆ Wooden handle

ITEM	DESCRIPTION	O.L.	UOM	CASE
APP-26	12" x 14" Blade	26"	Each	6/12
APP-36	12" x 14" Blade	36"	Each	6/12
APP-52	12" x 14" Blade	52"	Each	6/12
APP-10M	14" x 16" Blade	26"	Each	6/12
APP-18M	14" x 16" Blade	34"	Each	6/12
APP-18L	16" x 18" Blade	36"	Each	6/12

## WOODEN PIZZA PEELS

ITEM	DESCRIPTION	O.L.	UOM	CASE
WPP-1222	12" x 13" Blade	22"	Each	12
WPP-1236	12" x 13" Blade	36"	Each	12
WPP-1242	12" x 13" Blade	42"	Each	12
WPP-1424	14" x 15" Blade	24"	Each	12
WPP-1436	14" x 15" Blade	36"	Each	12
WPP-1442	14" x 15" Blade	42"	Each	12
WPP-1642	16" x 17-1/2" Blade	42"	Each	6
WPP-1842	18" x 19" Blade	42"	Each	6
WPP-2042	20" x 20" Blade	42"	Each	6

## PIZZA KNIVES & CUTTERS



KSTK-40



PWC-4



PPC-4



VP-316



PPC-4W



PPC & VP-SERIES



KPP-18



KPP-20



PIZZA KNIVES

## SOFT-TEK™ PIZZA CUTTER

The specially designed soft-touch, non-slip handle now available as a pizza cutter!

- ◆ Razor sharp 4" diameter blade
- ◆ Protective finger guard

ITEM	DESCRIPTION	BLADE	UOM	CASE
KSTK-40	Sof-Tek Handle	4" Dia	Each	6/36

## PIZZA CUTTERS

- ◆ NSF listed (Plastic handles)

ITEM	DESCRIPTION	BLADE	UOM	CASE
PWC-4	Wooden Handle	4" Dia	Each	12/72
PPC-2	Black PP Hdl, NSF	2-1/2" Dia	Each	12/72
PPC-4	Black PP Hdl, NSF	4" Dia	Each	12/72
PPC-2W	White PP Hdl, NSF	2-1/2" Dia	Each	12/72
PPC-4W	White PP Hdl, NSF	4" Dia	Each	12/72
VP-315	Small, Soft Grip Handle, NSF	2-1/2" Dia	Each	12/72
VP-316	Large, Soft Grip Handle, NSF	4" Dia	Each	12/72

## PIZZA KNIVES

- ◆ NSF listed

ITEM	DESCRIPTION	UOM	CASE
KPP-18	18" Pizza Knife	Each	6/24
KPP-20	20" Pizza Rocker Knife	Each	6/24

### PIZZA SERVER

- ◆ Stainless steel
- ◆ Reinforced ergonomic PP handle
- ◆ NSF listed

ITEM	DESCRIPTION	UOM	CASE
TKP-62	6-7/8" x 5-7/8"	Each	6/24

### PIZZA SERVERS



TKP-62 NSF

### PIZZA SERVING TONGS

No more burnt hands/fingers with this sanitary solution for serving hot slices!

- ◆ 18/8 stainless steel
- ◆ Dishwasher Safe

ITEM	DESCRIPTION	UOM	CASE
PZG-6	5-1/2" x 4-1/2" Blade	Each	12/48



PATENTED

GRAB n' SERVE

PZG-6

### ADJUSTABLE SHAKER DREDGE

- ◆ 18/8 stainless steel mirror finish
- ◆ Features a three-way adjustable top with small, medium and large holes

ITEM	DESCRIPTION	UOM	CASE
DRG-8P	8 Oz	Each	12/96

### DREDGES



DRG-8P Adjustable Top

### STAINLESS STEEL DREDGES

ITEM	DESCRIPTION	UOM	CASE
DRG-10	10 Oz w/ Handle	Each	12/144
DRG-10H	10 Oz w/o Handle	Each	12/144
DRG-22H	22 Oz w/o Handle	Each	12/48



DRG-8P



DRG-10



DRG-10H

DRG-22H

### ALUMINUM DREDGES

ITEM	DESCRIPTION	UOM	CASE
ADRG-10	10 Oz w/ Handle	Each	12/144
ADRG-10H	10 Oz w/o Handle	Each	12/144



ADRG-10



ADRG-10H

### PLASTIC DREDGE SETS

- ◆ 10 oz polycarbonate dredge sets with snap-on lids
- ◆ NSF listed

ITEM	DESCRIPTION	UOM	CASE
PDG-10	10 Oz w/3 Clear Lids (S,M,L)	Set	1/48
PDG-10AC	10 Oz w/4 Colored Lids	Set	1/48
PDG-10CS	10 Oz w/Clear S Lid	Set	12/48
PDG-10CM	10 Oz w/Clear M Lid	Set	12/48
PDG-10CL	10 Oz w/Clear L Lid	Set	12/48
PDG-10CXL	10 Oz w/Clear XL Lid	Set	12/48
PDG-10B	10 Oz w/Beige Lid	Set	12/48
PDG-10G	10 Oz w/Green Lid	Set	12/48
PDG-10R	10 Oz w/Rose Lid	Set	12/48
PDG-10Y	10 Oz w/Yellow Lid	Set	12/48



PDG-10AC

PDG-10



PDG-SERIES W/COLORED LIDS



PDG-SERIES W/CLEAR LIDS

### PLASTIC COLORED DREDGE LIDS

- ◆ Fits both PDG-10 and PDG-10AC dredges
- ◆ NSF listed

ITEM	DESCRIPTION	UOM	CASE
PDG-BL	Beige Lids, 6-Pcs/Pk	Pack	72/144
PDG-GL	Green Lids, 6-Pcs/Pk	Pack	72/144
PDG-RL	Rose Lids, 6-Pcs/Pk	Pack	72/144
PDG-YL	Yellow Lids, 6-Pcs/Pk	Pack	72/144



PDG-SERIES COLORED LIDS

PDG-SERIES NSF

## DOUGH PREPARATION



ALDP-SERIES

## DOUGH RETARDING/PROOFING PANS & COVERS

- ◆ Stackable for easy storage
- ◆ Aluminum

ITEM	DESCRIPTION	UOM	CASE
ALDP-48	48 Oz, 7-7/8"Dia x 3"H	Each	12/24
ALDP-48C	Cover for ALDP-48	Each	120
ALDP-96	96 Oz, 8-3/4"Dia x 3"H	Each	12/24
ALDP-96C	Cover for ALDP-96	Each	120

## DOUGH BOXES & COVER

- ◆ Boxes stack tight to maintain freshness of contents
- ◆ Great for storing and proofing dough
- ◆ Reinforced structure resists breakage or bending over time
- ◆ Made of durable polypropylene
- ◆ BPA-free



PL-36NC

IMPROVED  
STRUCTURE

PL-3N

PL-6N

PL-SERIES

ITEM	DESCRIPTION	UOM	CASE
PL-3N	25-5/8"L x 18"W x 3-1/4"H	Each	6
PL-6N	25-1/2"L x 17-1/2"W x 6"H	Each	3
PL-36NC	Cover	Each	12



Stackable

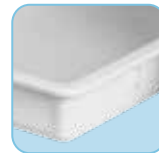

Reinforced edges & corners

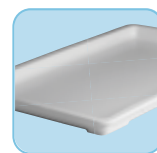

Lid can be used as a tray



Seamless fit for extra fresh storage needs

## DOUGH BOX DOLLY



Transport dough boxes

DWR-2617

## WIRE DOUGH BOX DOLLY

*Transport multiple dough boxes with ease using this wire dolly, currently the only one on the market!*

- ◆ Capacity up to 400 Lbs
- ◆ Winco® exclusive
- ◆ Wheels measure 3-3/4" diameter each

ITEM	DESCRIPTION	UOM	CASE
DWR-2617	27"L x 18-1/4"W x 2-1/2"H	Each	1
DWR-CT	Caster for DWR-2617	Each	4/24
DWR-CTB	Caster w/ Brake for DWR-2617	Each	4/24



**STAINLESS STEEL MIXING PADDLES**

ITEM	DESCRIPTION	UOM	CASE
MPD-24	24"	Each	12
MPD-36	36"	Each	12
MPD-48	48"	Each	12
MPD-60	60"	Each	12

**MIXING PADDLES**

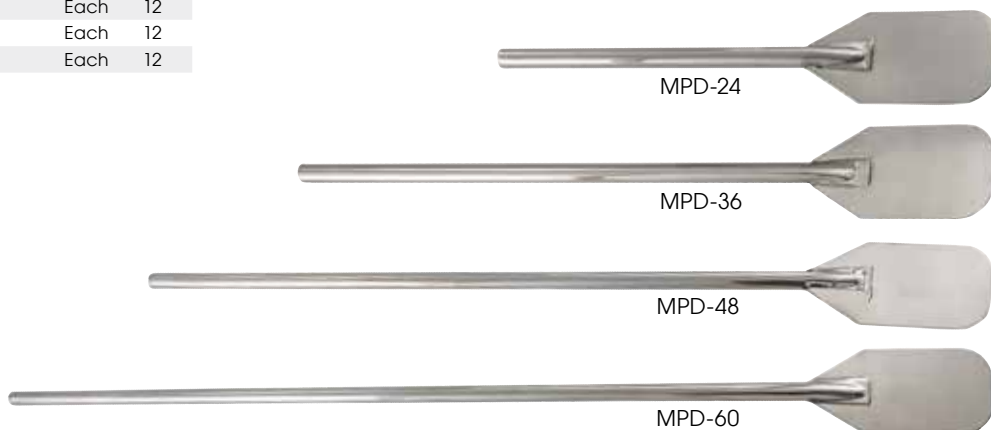

**STAINLESS STEEL DOUGH SCRAPERS**

ITEM	DESCRIPTION	SIZE (L X W)	UOM	CASE
DSC-1	Steel Handle	5-1/4" x 4-1/4"	Each	12/48
DSC-2	Plastic Handle, NSF	6" x 3"	Each	12/72
DSC-2W	Plastic Handle, NSF	6" x 3"	Each	12/72
DSC-3	Wooden Handle	6" x 3"	Each	12/72



**DOUGH SCRAPERS**



**PLASTIC DOUGH SCRAPERS**

ITEM	DESCRIPTION	SIZE (L X W)	UOM	CASE
PDS-7	Large, 6-Pcs/Pk	7-1/2" x 4-3/4"	Pack	24/48
PDS-5	Small, 12-Pcs/Pk	5-1/2" x 3-3/4"	Doz	21/42



**ALLERGEN-FREE DOUGH SCRAPERS**

Solve the challenges of maintaining an allergen-aware kitchen! Improve customer dining experiences while raising the bar for food safety. Prevent cross-contaminating allergens with the extensive line of Allergen-Free tools by Winco®. Whether it's gluten, nuts or more, use this stand-out purple color to designate these dough scrapers as allergen-free.

ITEM	DESCRIPTION	SIZE (L X W)	UOM	CASE
DSC-2P	Dough Scraper, Plstc Hdl, S/S Blade	6" x 3"	Each	12/72
PDS-7P	Plastic Dough Scrapers, 6-Pcs/Pk	7-1/2" x 4-3/4"	Pack	24/48



## ROLLING PINS



ARP-18



WRP-18



WRP-20F

### ALUMINUM ROLLING PINS

◆ 3-1/2" diameter

ITEM	DESCRIPTION	UOM	CASE
ARP-13	13"L	Each	1/6
ARP-15	15"L	Each	1/6
ARP-18	18"L	Each	1/6

### WOODEN ROLLING PINS

◆ 2-3/4" diameter

ITEM	DESCRIPTION	UOM	CASE
WRP-13	13"L	Each	12
WRP-15	15"L	Each	12
WRP-18	18"L	Each	12

### FRENCH WOODEN ROLLING PIN

◆ 1-3/16" diameter

ITEM	DESCRIPTION	UOM	CASE
WRP-20F	20" Tapered	Each	12/48

## DOUGH DIVIDERS & DOCKERS

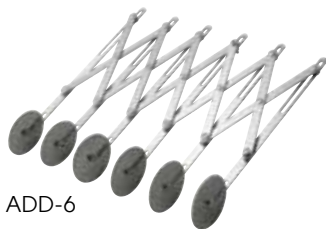

ADD-6

### DOUGH DIVIDERS WITH ADJUSTABLE WHEELS

◆ Stainless steel wheels adjustable from 3/4" to approximately 4-3/4" for ADD-6 and 4-3/8" for ADD-5

ITEM	DESCRIPTION	UOM	CASE
ADD-5	5-Wheel	Each	36
ADD-6	6-Wheel	Each	36

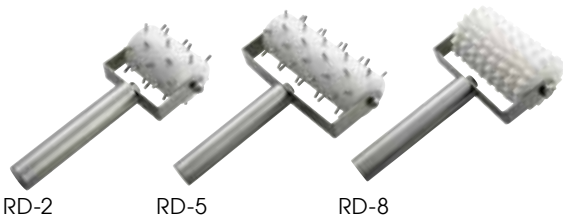

RD-2

RD-5

RD-8

### DOUGH ROLLER DOCKERS

◆ Stainless steel handle  
◆ 8" Overall Length

ITEM	DESCRIPTION	UOM	CASE
RD-2	2-5/8"W Head	Each	1/24
RD-5	5"W Head	Each	1/24
RD-8	5"W Head, 8-Wheel	Each	1/24



RD-4P

RD-5P

### PLASTIC ROLLER DOCKERS

◆ 6 independently spinning wheels on the RD-4P  
◆ Prevent bubbles from forming

ITEM	DESCRIPTION	UOM	CASE
RD-4P	4"W Head, Molded Ergonomic Handle	Each	1/24
RD-5P	5"W Head, Plastic Handle	Each	12/72

## ROTARY SIFTER



RFS-8

### ROTARY SIFTER

ITEM	DESCRIPTION	UOM	CASE
RFS-8	8 Cup, S/S	Each	1/12

### DELIVERY BAGS

- ◆ Outer shell / liner: polyester, Filling: EPE
- ◆ Heat retention: 2 hours @ 167°F; 4 hours @ 131°F; 6 hours @ 95°F

ITEM	DESCRIPTION	UOM	CASE
BGDV-12	12" x 12" x 12"	Each	6
BGDV-22	22" x 22" x 12"	Each	6

### PIZZA BAGS



BGDV-SERIES

### PIZZA BAGS

- ◆ Outer shell / liner: polyester, Filling: EPE
- ◆ Insulated lining keeps food warm for longer periods of time

ITEM	DESCRIPTION	UOM	CASE
BGPZ-18	18" x 18" x 5"	Each	6
BGPZ-20	20" x 20" x 5"	Each	6
BGPZ-24	24" x 24" x 5"	Each	6

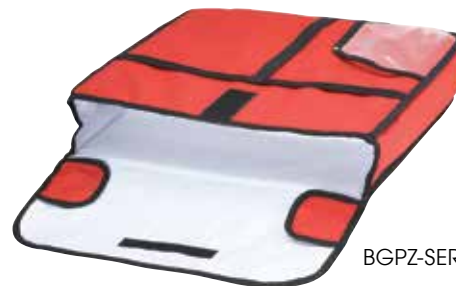

BGPZ-SERIES



### DUAL-HEADED BRUSH

- ◆ Thick brush has steel wire bristles trimmed to 40mm
- ◆ Thin brush has flat steel wire bristles trimmed to 30mm
- ◆ Replacement kit includes dual-head brush, bolt and nut

ITEM	DESCRIPTION	UOM	CASE
BR-21	Dual-Headed Brush with 28" S/S Handle	Each	6

### PIZZA OVEN BRUSHES



BR-21

### PIZZA OVEN/BROILER BRUSH

- ◆ Stiff stainless steel wire bristles make cleaning heavy oven residue effortless
- ◆ Quick and easy removal of heavy carbon deposits, rust and burned-on food buildup

ITEM	DESCRIPTION	UOM	CASE
BR-30	Brush with 30" Hdl	Each	8/32

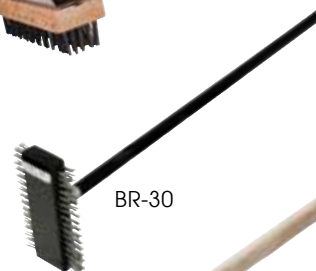

BR-30

### PIZZA OVEN SCRAPER

- ◆ Carbon wire brush; metal scraper

ITEM	DESCRIPTION	UOM	CASE
BR-27	Scraper with 27" Hdl	Each	12



BR-27

### PIZZA OVEN BRUSH HEAD

- ◆ Brass bristles; metal scraper

ITEM	DESCRIPTION	UOM	CASE
BR-10	Brush Head, 10-1/4" x 1-3/8" x 1-3/4"	Each	12/48
BR-36W	36" Wooden Hdl for BR-10	Each	48
BR-60W	55" Wooden Hdl for BR-10	Each	6/24



BR-10

BR-36W

BR-60W



## COMMERCIAL MANUAL CAN OPENERS



**NSF  
CERTIFIED**



CO-3N with blade removed



Securely clamps to work surface



CO-3N in use

### PREMIUM MANUAL CAN OPENERS

Our premium European-made heavy-duty nickel-plated can opener is fitted with a removable clamp, it is ideal for on-the-go operations that require flexibility. The rust-resistant stainless steel blade and gear effectively opens various can sizes up to #10.

- ◆ Includes base, blade, gear and installation kit for mounting on wooden or stainless steel work tables
- ◆ Easily disassembles for cleaning/sanitizing
- ◆ Heavy-duty nickel-plated steel construction
- ◆ Rigid universal mounting base for screw-down or clamp-on installation with wooden or stainless steel work tables
- ◆ 19" (482mm) long bar accommodates various sizes of cans up to 16" (406mm) tall
- ◆ Quick change dual-sided tempered knife blade and stainless steel gear
- ◆ NSF listed
- ◆ One year parts and labor warranty

ITEM	DESCRIPTION	UOM	CASE
CO-3N	Nickel Plated, Steel Base, NSF*		
CO-3N-B	1-Pc S/S Replacement Blade for CO-3N	Each	1
CO-3G	1-Pc S/S Replacement Gear Set for CO-3N	Each	1

\*Replaces CO-3



CO-3N-B



CO-3G



CO-3N portable clamp



CO-3N

**STAINLESS STEEL  
BLADE & GEAR  
PORTABLE CLAMP  
INCLUDED**

### STANDARD #1 MANUAL CAN OPENER

The go-to industry standard, steel body can opener, made for heavy usage kitchen environments that require processing of up to 50 cans a day. Opens various can sizes up to #10.

- ◆ Includes base, blade, gear and installation kit
- ◆ Rigid universal mounting base for screw-down to a wooden or stainless steel work tables
- ◆ 13" (330mm) long bar accommodates any size can up to 10" (254mm) tall
- ◆ Extra-durable dual-sided knife blade and gears are interchangeable with most other can opener brands
- ◆ One year parts and labor warranty



CO-1



Securely clamps to work surface

ITEM	DESCRIPTION	UOM	CASE
CO-1	Cast Iron Body	Set	1
CO-1B	2-Pc Replacement Blade Set for CO-1	Set	24/288
CO-1G	1-Pc Replacement Gear Set for CO-1	Each	12/144



CO-1B



CO-1G

### QUICK-SLICE FRUIT & VEGETABLE SLICER

Save on time and labor with the Kattex Fruit & Vegetable Slicer by simply putting produce in the holder to turn out uniform slices in seconds.

- ◆ Aluminum construction with 9-1/4" stainless steel adjustable blade
- ◆ Easy to use calibrated 1/16"(1mm) to 1/2"(12mm) slice thickness gauge
- ◆ Mounts to countertops and other flat surfaces, can easily be removed for storage and cleaning
- ◆ Can accommodate fruits and vegetables with a maximum of 4" diameter and 5-1/2" in length

MODEL	OVERALL DIMENSIONS			SHIP WEIGHT
	LENGTH	DEPTH	HEIGHT	
FVS-1	16" (406mm)	8-11/16" (220mm)	16" (406mm)	12.13 lbs (5.5 kg)

ITEM	DESCRIPTION	UOM	CASE
FVS-1	21"L x 10-3/4"W x 16"H	Each	1/2
FVS-1B	2-Pc Replacement Blades	Set	1/10
FVS-1SB	Replacement Shaft and Blade Turntable Assembly	Each	1/6

## KATTEX™ FRUIT & VEGETABLE SLICER



FVS-1



Thickness gauge



Replacement blade

### CUTTING BOARD MOUNT FOR FRUIT & VEGETABLE SLICER

Add portability to the KATTEX Fruit and Vegetable Slicer (FVS-1) with this customized STATIKBOARD™ cutting board mount. The molded-through, non-slip feet prevent slipping & sliding, even on wet countertops, and the fully-rubberized hook provides easy storage.

- ◆ Size: 12" x 18" x 1/2"
- ◆ Built-in hook for easy transport and hygienic storage
- ◆ Dishwasher safe tough durable copolymer board construction
- ◆ Stainless steel flush mounting hardware included (mounting bracket sold separately or comes with the Fruit & Vegetable Slicer)
- ◆ NSF listed

ITEM	DESCRIPTION	UOM	CASE
CBM-1218	Cutting Board Mount for FVS-1	Each	1

## STATIKboard™



**NEW**

**PATENTED ORIGINAL DESIGN**

CBM-1218 **NSF**



FVS-1 & CBM-1218

# KATTEX™ TOMATO SLICERS



TTS-188

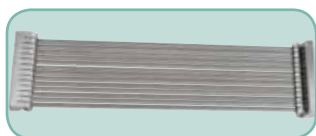

TTS-188-B

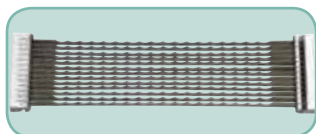

TTS-188S-B

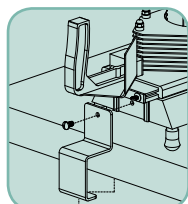

Stop/hold bracket included



KAT-WR

**NSF** TTS-SERIES

## PRECISE-SLICE TOMATO SLICERS

*With one quick push, smoothly and swiftly slice tomatoes with the stainless steel Kattex tomato slicer.*

- ◆ Durable cast aluminum construction
- ◆ Aluminum frame with stainless steel replaceable blades
- ◆ Ergonomic vertical handle for effortless slicing
- ◆ Cuts 2 dozen tomatoes into 3/16" or 1/4" thick slices in only 1 minute
- ◆ HDPE board ensures safe & durable food processing
- ◆ Rubber non-slip feet to ensure maximum stability
- ◆ Slicers come standard with table stop bracket
- ◆ NSF listed

MODEL	OVERALL DIMENSIONS			SHIP WEIGHT
	LENGTH	DEPTH	HEIGHT	
TTS-188	16-1/2" (420mm)	8-1/4" (210mm)	9-1/2" (240mm)	9.27 lbs (4.2 kg)
TTS-188S				
TTS-250				
TTS-250S				

ITEM	DESCRIPTION	UOM	CASE
TTS-188	3/16" Cuts w/Straight Blade	Set	1/4
TTS-188S	3/16" Cuts w/Serrated Blade	Set	1/4
TTS-250	1/4" Cuts w/Straight Blade	Set	1/4
TTS-250S	1/4" Cuts w/Serrated Blade	Set	1/4

## TOMATO SLICER ACCESSORIES

ITEM	DESCRIPTION	UOM	CASE
TTS-188-B	3/16" Straight Blade Assembly for TTS-188	Set	1/12
TTS-188S-B	3/16" Serrated Blade Assembly for TTS-188	Set	1/12
TTS-250-B	1/4" Straight Blade Assembly for TTS-250	Set	1/12
TTS-250S-B	1/4" Serrated Blade Assembly for TTS-250	Set	1/12
KAT-FT	4-Pc Replacement Feet Set	Set	1
KAT-WR	Dual-End Wrench	Each	1/25

# KATTEX™ ONION SLICERS



OS-250



KAT-WR



OS-250B  
Blade set assembly

**NSF** OS-SERIES

## QUICK-SLICE ONION SLICERS

*Just one smooth stroke of the Kattex Onion Slicer will produce evenly sliced coins of fruits and vegetables, perfect on salads, in cocktails and more.*

- ◆ Aluminum construction with stainless steel blades
- ◆ Unique lever-handle allows for quick and easy operation
- ◆ Sturdy base with non-skid feet
- ◆ Two blades included can be stacked to create a finer cut
- ◆ 4-1/2" x 3-3/4" cutting area
- ◆ NSF listed

MODEL	OVERALL DIMENSIONS			SHIP WEIGHT
	LENGTH	DEPTH	HEIGHT	
OS-188	19" (483mm)	10" (254mm)	19" (483mm)	17.79 lbs (8.06 kg)
OS-250				

ITEM	DESCRIPTION	UOM	CASE
OS-188	3/16" Cuts	Each	1/2
OS-250	1/4" Cuts	Each	1/2

## ONION SLICER ACCESSORIES

ITEM	DESCRIPTION	UOM	CASE
OS-188B	3/16" Blade Set Assembly for OS-series, 2-Ps/Set	Set	1/10
OS-250B	1/4" Blade Set Assembly for OS-series, 2-Pcs/Set	Set	1/10
KAT-FT	4-Pc Replacement Feet Set	Set	1
KAT-BS-OT	4-Pc Replacement Bushings	Set	1
KAT-WR	Dual-End Wrench	Each	1/25

### QUICK-SLICE LETTUCE CUTTER

Cut multiple heads of crisp, fresh lettuce in seconds with the Kattex Lettuce Cutter. Features interlocking scalloped pretensioned blades to cut 1" squares of cored lettuce without bruising and browning.

- ◆ Aluminum frame with easy-grip handle and stainless steel blade with 49 square cuts
- ◆ Cuts lettuce into 1" x 1" slices in less than 1 minute
- ◆ Field convertible into 1"x2" cut for Romaine lettuce
- ◆ Rubber feet prevent slipping/scratching on work surface
- ◆ 7" x 7" cutting area
- ◆ NSF listed

MODEL	OVERALL DIMENSIONS			SHIP WEIGHT
	LENGTH	DEPTH	HEIGHT	
TLC-1	13" (330mm)	18" (457mm)	20" (508mm)	17.79 lbs (8.06 kg)

ITEM	DESCRIPTION	UOM	CASE
TLC-1	Lettuce Cutter	Each	1/2
TLC-1-B	Replacement Blade for TLC-1	Each	1/10
KAT-FT	4-Pc Replacement Feet Set	Set	1
KAT-BS-OT	4-Pc Replacement Bushings	Set	1
KAT-WR	Dual-End Wrench	Each	1/25

## KATTEX™ LETTUCE CUTTER



TLC-1



KAT-WR

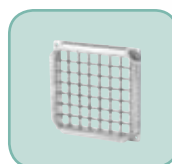

TLC-1-B

TLC-1 NSF

### QUICK-SLICE CHEESE SLICERS

The Kattex Cheese Slicers make light work of cutting through a variety of semi-soft cheeses, resulting in uniform cuts. Ideal for portion control and faster food prep.

- ◆ Cast aluminum construction with stainless steel wires
- ◆ Cutting area accommodates 1/3 of a 5 lbs cheese block
- ◆ Cuts 3/8" or 3/4" cheese sticks, cubes or slices
- ◆ Cleaning brush included
- ◆ NSF listed

MODEL	OVERALL DIMENSIONS			SHIP WEIGHT
	LENGTH	DEPTH	HEIGHT	
TCT-375	13-1/4" (335mm)	6-3/4" (170mm)	4-1/2" (115mm)	4.21 lbs (1.91 kg)
TCT-750				

ITEM	DESCRIPTION	UOM	CASE
TCT-375	3/8" Cuts	Each	1/4
TCT-375B	Replacement Bow for TCT-375	Set	1/10
TCT-750	3/4" Cuts	Each	1/4
TCT-750B	Replacement Bow for TCT-750	Set	1/10

## KATTEX™ CHEESE SLICERS



TCT-375

TCT-750



TCT-375B  
3/8" wide cuts



TCT-750B  
3/4" wide cuts



Uniformly slice cheese blocks

TCT-SERIES NSF

# KATTEX™ CHOPPERS/DICERS



HCD-250

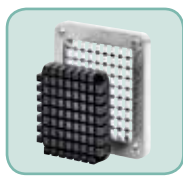

Replacement blade and block

**NSF** HCD-SERIES

## QUICK-SLICE CHOPPERS/DICERS

The Kattex Chopper/Dicer produces perfectly diced onions, tomatoes and cucumbers too.

- ◆ Cast aluminum construction with stainless steel blades
- ◆ Sturdy base with non-skid feet
- ◆ 3-3/8" x 3-3/8" cutting area
- ◆ NSF listed

MODEL	OVERALL DIMENSIONS			SHIP WEIGHT
	LENGTH	DEPTH	HEIGHT	
HCD-250	7-15/16" (200mm)	7-15/16" (200mm)	18-1/2" (470mm)	7.05 lbs (3.2 kg)
HCD-375				
HCD-500				

ITEM	DESCRIPTION	UOM	CASE
HCD-250	1/4" Cuts	Each	1/4
HCD-375	3/8" Cuts	Each	1/4
HCD-500	1/2" Cuts	Each	1/4

## CHOPPER/DICER ACCESSORIES

ITEM	DESCRIPTION	UOM	CASE
HCD-250BK	1/4" Replacement Blade & Block for HCD-series	Set	1/10
HCD-375BK	3/8" Replacement Blade & Block for HCD-series	Set	1/10
HCD-500BK	1/2" Replacement Blade & Block for HCD-series	Set	1/10
HCD-BR	2-Pc Black Rubber Ring	Set	1/50
KAT-FT	4-Pc Replacement Feet Set	Set	1
KAT-BS-FH	4-Pc Replacement Bushings	Set	1

# KATTEX™ FRUIT WEDGE SLICERS



FWS-8



FWS-6BC  
Apple corer blade



FWS-6BK  
Replacement wedger and blade for citrus fruits

**NSF** FWS-SERIES

## QUICK-SLICE FRUIT WEDGE SLICERS

Get quick and uniform wedges of fruit with a push of the handle. Ideal for coring and sectioning apples, lemons, limes, oranges, and tomatoes.

- ◆ Aluminum construction with sharp stainless steel blades that minimize squeezing and bruising
- ◆ Sturdy base with non-skid feet
- ◆ 3-1/2" diameter cutting area
- ◆ NSF listed

MODEL	OVERALL DIMENSIONS			SHIP WEIGHT
	LENGTH	DEPTH	HEIGHT	
FWS-6	7-15/16" (200mm)	7-15/16" (200mm)	18-1/2" (470mm)	5.74 lbs (2.6 kg)
FWS-8				

ITEM	DESCRIPTION	UOM	CASE
FWS-6	6-Wedge	Each	1/4
FWS-8	8-Wedge	Each	1/4

## FRUIT WEDGE SLICER ACCESSORIES

ITEM	DESCRIPTION	UOM	CASE
FWS-6BK	6-Section Wedger & Blade Replacement for FWS-series	Set	1/10
FWS-8BK	8-Section Wedger & Blade Replacement for FWS-series	Set	1/10
FWS-6BC	6-Slice Apple Corer for FWS-Series	Each	10
FWS-8BC	8-Slice Apple Corer for FWS-Series	Each	10
KAT-FT	4-Pc Replacement Feet Set	Set	1
KAT-BS-FH	4-Pc Replacement Bushings	Set	1



### QUICK-SLICE FRENCH FRY CUTTERS - HEAVY-DUTY

- ◆ Short throw handle design for smooth and uniform cuts in one stroke
- ◆ Extremely durable cast iron body with stainless steel components
- ◆ Affix to counter or wall mount; wall bracket sold separately
- ◆ Accessories to modify cut sizes and styles sold separately
- ◆ 3-3/8" x 3-3/8" cutting area
- ◆ NSF listed

MODEL	OVERALL DIMENSIONS			SHIP WEIGHT
	LENGTH	DEPTH	HEIGHT	
HFC-250	8" (203mm)	14" (355mm)	16-3/4" (425mm)	12.68 lbs (5.75 kg)
HFC-375				13.6 lbs (6.17 kg)
HFC-500				13.23 lbs (6 kg)

ITEM	DESCRIPTION	UOM	CASE
HFC-250	1/4" Cut French Fry Cutter	Set	1
HFC-375	3/8" Cut French Fry Cutter	Set	1
HFC-500	1/2" Cut French Fry Cutter	Set	1

### FRENCH FRY CUTTER ACCESSORIES

ITEM	DESCRIPTION	UOM	CASE
HFC-250R	1/4" Cut Replacement Blade	Set	1/48
HFC-375R	3/8" Cut Replacement Blade	Set	1/48
HFC-500R	1/2" Cut Replacement Blade	Set	1/48
HFC-250B	1/4" Cut Blade Assembly	Set	1/24
HFC-375B	3/8" Cut Blade Assembly	Set	1/24
HFC-500B	1/2" Cut Blade Assembly	Set	1/24
HFC-250K	Pusher Block for 1/4" and 1/2" Cut Blade	Each	1/24
HFC-375K	Pusher Block for 3/8" Cut Blade	Each	1/24
HFC-BK	Wall Bracket for HFC series	Each	1/12

## KATTEX™ FRENCH FRY CUTTERS - HEAVY-DUTY



HFC-375



Wall mounted with HFC-BK

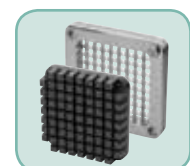

Replacement block and cut blade assembly

HFC-SERIES 

### FRENCH FRY CUTTERS - MEDIUM-DUTY

- ◆ Made of heavy-duty cast iron and fitted with sharp stainless steel blades for even slicing
- ◆ Ergonomic handles makes for easy operating and sturdy legs provide stability on flat countertop surfaces

MODEL	OVERALL DIMENSIONS			SHIP WEIGHT
	LENGTH	DEPTH	HEIGHT	
FFC-250	8" (203mm)	14" (355mm)	16-3/4" (425mm)	11.55 lbs (5.24 kg)
FFC-375				
FFC-500				

ITEM	DESCRIPTION	UOM	CASE
FFC-250	1/4" Cut	Each	1
FFC-375	3/8" Cut	Each	1
FFC-500	1/2" Cut	Each	1

### FRENCH FRY CUTTERS - MEDIUM-DUTY



FFC-375

### FRENCH FRY CUTTER ACCESSORIES

ITEM	DESCRIPTION	UOM	CASE
FFC-250B	Blade Assembly for FFC-250	Each	24
FFC-250K	Pusher Block for FFC-250	Each	24
FFC-375B	Blade Assembly for FFC-375	Each	24
FFC-375K	Pusher Block for FFC-375	Each	24
FFC-500B	Blade Assembly for FFC-500	Each	24
FFC-500K	Pusher Block for FFC-500	Each	24
FFC-500P	Pusher Support for FFC-Series	Each	12



FFC-500P

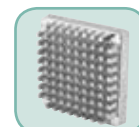

FFC-250K



FFC-250B

## CONDIMENT DISPENSER



IMPROVED

BPA FREE

PKTS-SERIES

PKTS-2D

## CONDIMENT DISPENSER

Ideal for busy bars, food stands, convenience stores or fast-food service. Removable plastic fountain jars allow for easy cleaning and refilling.

- ◆ Durable 18/8 stainless steel
- ◆ Heavy-duty pump ideal for high-volume restaurant environment
- ◆ Two (2) 3-1/2 Qt plastic fountain jars included (7 Qt total)
- ◆ Each pump dispenses between 1 oz and 1-1/4 oz portions, depending on thickness of condiments
- ◆ Overall dimensions: 11"L x 8-3/4"W x 16"H (with pump)

ITEM	DESCRIPTION	UOM	CASE
PKTS-2D	Condiment Dispenser with 2 Standard Pumps	Set	1/2
PKTS-PT01	Individual Pump with Lid	Each	1
PKTS-PT02	Replacement Plastic Fountain Jar	Each	1
PKTS-PT03	Stainless Steel Casing	Each	1

## DIGITAL SCALE

22 LB CAPACITY

6" x 6" Platform



NSF

SCAL-D22

## DIGITAL PORTION CONTROL SCALE

Accurately weigh ingredients with measurements of either kilograms, grams, pounds or ounces.

- ◆ Achieve consistency with portion control
- ◆ Removable stainless steel platform can be used as a tray
- ◆ Auto-shutoff after three (3) minutes of inactivity when powered by batteries
- ◆ Piece count, unit and tare functions
- ◆ Measures in five (5) different units - lb:oz, lb, oz, kg, g
- ◆ Manual field recalibration for accuracy and precision
- ◆ Includes three (3) AAA batteries and AC adapter
- ◆ 2-1/2"L x 1"W backlight LCD screen

ITEM	DESCRIPTION	CAPACITY	UOM	CASE
SCAL-D22	2-1/2" x 1" Digital Screen	22 Lb / 10 kg	Set	1/36

Replace SCAL-D20

## MECHANICAL SCALES



SCLH-2

SCLH-50



SCAL-840

## PREMIUM MECHANICAL KITCHEN SCALES

- ◆ Heavy-duty stainless steel mechanical scale with 8" platform
- ◆ Shatter-proof lens protects dial
- ◆ Durable and corrosion-resistant

ITEM	DESCRIPTION	CAPACITY	GRADATIONS	UOM	CASE
SCLH-2	8" Dial	32 Oz	1/8 Oz / 10 g	Each	1/4
SCLH-50	8" Dial	50 Lb	1/8 Lb / 500 g	Each	1/4

## MECHANICAL RECEIVING SCALES

- ◆ Stainless steel platform is large, stable and easy-to-clean
- ◆ 8" and 9" scales are calibrated to Lbs as the base measurement

ITEM	DESCRIPTION	CAPACITY	GRADATIONS	UOM	CASE
SCAL-62	6.5" Dial	2 Lb / 1 kg	1/4 Oz / 5 g	Each	8
SCAL-66	6.5" Dial	6 Lb / 3 kg	1/2 Oz / 10 g	Each	8
SCAL-810	8" Dial	10 Lb / 4.55 kg	1 Oz / 25 g	Each	6
SCAL-820	8" Dial	20 Lb / 9.09 kg	1 Oz / 50 g	Each	6
SCAL-840	8" Dial	40 Lb / 18.18 kg	2 Oz / 100 g	Each	6
SCAL-960	9" Dial	60 Lb / 27.27 kg	4 Oz / 100 g	Each	2
SCAL-9100	9" Dial	100 Lb / 45.45 kg	4 Oz / 100 g	Each	2
SCAL-9130	9" Dial	130 Lb / 59.09 kg	8 Oz / 200 g	Each	2



### WHIPPED CREAM DISPENSER

Whip up freshly-made creams, rich mousse, syrups, sauces and more to top off inspired creations.

- ◆ Includes three (3) decorating tips to create unique dessert and beverage presentations, and a brush to easily clean them
- ◆ Capacity: 1 Pint (0.5L)
- ◆ Fits standard 8gm N2O cartridge (*not included*), and compatible with all brands of whipped cream chargers/cartridges
- ◆ Durable aluminum bottle and stainless steel handle
- ◆ Hand-wash only

ITEM	DESCRIPTION	SIZE	UOM	CASE
CW-A05	Whipped Cream Dispenser w/3 Tips & 1 Brush	3" Dia x 12"H	Each	1/12
CW-P	3 Tips With 1 Cleaning Brush		Set	
CW-PG	Replacement Gasket, 3-Pcs/Pk		Pack	

### WHIPPED CREAM DISPENSER



CW-A05

CARTRIDGE NOT INCLUDED

THREE (3) DECORATING TIPS

BPA FREE

### PREMIUM MANDOLINE SLICERS

- ◆ **MDL-18** features rubberized handle for a non-slip grip and rotary side dial for precise thickness control.
- ◆ Includes three (3) built-in blade styles at varying thicknesses:
- ◆ SLICE - 1/8", 1/4", 3/8"
- ◆ SERRATED/WAFFLE - 1/8", 1/4", 3/8"
- ◆ JULIENNE - 1/8", 3/8"

- ◆ **MDL-15** includes five (5) interchangeable blades
- ◆ Non-skid, folding stand for compact storage
- ◆ Easy-to-clean stainless steel body
- ◆ Each set includes an easy-grip stainless steel hand guard

ITEM	DESCRIPTION	UOM	CASE
MDL-18	Mandoline Slicer Set, 3 Built-in Blade Styles	Set	1/8
MDL-15	Mandoline Slicer Set, 5 Interchangeable Blades	Set	1/8
MDL-BLD	5-Blade Set for MDL-15	Set	12/48
MDL-HD	Hand Guard for MDL-15	Each	12/36

### MANDOLINE SLICER SET

- ◆ Built-in julienne, and reversible slicing & serrated blades at varying thicknesses
- ◆ Non-skid, folding stand for compact storage
- ◆ Rotary adjustment dial
- ◆ Plastic body with rubberized; easy-grip hand guard

ITEM	DESCRIPTION	UOM	CASE
MDL-4P	Mandoline Slicer Set	Set	1/8

### JAPANESE MANDOLINE SLICER SET

Slice vegetables and fruits effortlessly! The built-in blade adjusts to desired thickness, and comes with fine, medium & coarse attachment blades.

- ◆ Professional blades provide clean and sharp cuts
- ◆ Great for carrots, onions, cucumbers and more
- ◆ Hand guard included

ITEM	DESCRIPTION	UOM	CASE
MDL-5P	Japanese Mandoline Slicer Set	Set	1/36
MDL-5PBS	3-Blade Set for MDL-5P	Set	1

### MANDOLINE SLICERS



MDL-BLD



MDL-18



MDL-HD



MDL-15



MDL-15 with MDL-HD

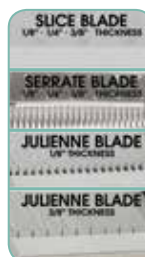

Built-in blade styles and thicknesses



MDL-4P



Shredding



Slicing



MDL-5PBS

## SLICERS & CHOPPER



**NSF** BGS-1

5"L x 2-1/4"W slot



VTS-3G



FCS-3

### BAGEL SLICER

*This commercial-grade polycarbonate bagel slicer promotes fast, convenient and safe slicing, an essential for quick-paced food service venues.*

- ◆ High-carbon, non-stick blade with serrated edge provides precise cuts on every slice
- ◆ Clear guard allows visibility & protects hands/fingers from injury
- ◆ Wide base helps maintain stability while in use
- ◆ Dishwasher safe

ITEM	DESCRIPTION	UOM	CASE
BGS-1	7"L x 3-1/2"W x 9"H	Set	1/12
BGS-1B	Replacement Blade w/ Guard	Each	1/12

### TURNING SLICER

- ◆ Produce beautiful vegetable strands and curly ribbons in minutes with a turn of the handle
- ◆ Perfect for garnishing, cooking, and making salads and coleslaws
- ◆ Includes plastic turner, built-in straight blade and 3 interchangeable julienne blades

ITEM	DESCRIPTION	UOM	CASE
VTS-3G	11"L x 5"W x 7-3/8"H	Each	1/12
VTS-3GBS	Serrated Blade Set for VTS-3G, 3-Pc: Coarse, Medium, Fine	Set	30

### FOOD CHOPPER

- ◆ 18/8 stainless steel construction with plastic base
- ◆ Zigzag-shaped blade rotates for dicing
- ◆ 0.5mm blade thickness

ITEM	DESCRIPTION	UOM	CASE
FCS-3	3" Dia	Each	6/24

## FOOD MILLS



SVM-12

*A great alternative to using a food processor, the Winco® stainless steel food mills are ideal for straining and puréeing cooked fruits and vegetables without retaining seeds, skin and fibers. Simply turn the crank and the semi-circular blade sweeps over, compresses and scrapes the food.*

### LARGE-SIZE FOOD MILL

- ◆ Comes with five (5) interchangeable cutting plates with varying perforations for a variety of textures
- ◆ Four with round perforations of 8mm, 4mm, 3mm or 2mm dia, and one with rectangular 3 x 8.5mm
- ◆ Output is approximately 3 lbs per minute and fits on a 7" or larger receptacle

ITEM	DESCRIPTION	SIZE	UOM	CASE
SVM-12	5 Qt	12-3/4"Dia	Set	1/4

### MEDIUM-SIZE STAINLESS STEEL FOOD MILLS

ITEM	DESCRIPTION	SIZE	UOM	CASE
SVM-3*	2 Qt w/3 Graters	8"Dia	Set	1/8
SVM-9	2 Qt w/3 Graters	9"Dia	Set	1/6

\*Replaces former SVM-8

**IMPROVED**



SVM-3



SVM-9

### PASTA MAKER

Roll out fresh sheets of pasta to make lasagnas and raviolis, strands of fettuccine and ribbons of pappardelle, all at thicknesses from 2mm to 6mm.

- ◆ Heavyweight chrome-plated stainless steel
- ◆ Clamps onto table or countertop for secure operation

ITEM	DESCRIPTION	UOM	CASE
NPM-7	7"L Roller	Set	1/6

### PRESSES, PEELER & SQUEEZER



NPM-7

### TORTILLA PRESSES

- ◆ Traditional press with excellent leverage
- ◆ Integrated handle allows for easy open and removal of corn and flour tortillas
- ◆ Great for making burritos, enchiladas and quesadillas

ITEM	DESCRIPTION	WEIGHT	UOM	CASE
TPC-8A	8"Dia, Aluminum, Non-Stick	1.52Lbs	Each	6/12
TPC-8C	8"Dia, Cast Iron	7.94Lbs	Each	1/4



TPC-8C

TPC-8A

PFOA FREE

### APPLE PEELER

This apple peeler is about efficiency and volume. Turn the handle and it quickly peels, slices and cores apples all at the same time.

- ◆ Cast aluminum body with sharp stainless steel blade
- ◆ Vacuum base holds peeler securely to any smooth surface
- ◆ Also ideal for pears, onions and potatoes

ITEM	DESCRIPTION	UOM	CASE
AP-12	10"L x 6"W x 4-1/4"H	Set	1/12



AP-12

### PREMIUM HAND PRESS CITRUS JUICER

These manual citrus press extract juice from fresh fruits with ease, maximizing yield by squeezing out every last drop. The strainer catches seeds and pulp while fresh-squeezed juice pours into the cup below.

- ◆ Sturdy, reinforced base; rubber feet prevent sliding
- ◆ Strong steel-post support and smooth lever action
- ◆ Ideal for medium to small citrus fruits

ITEM	DESCRIPTION	UOM	CASE
JC-19	19"H	Each	1/2



JC-19

### MARBLE MORTAR & PESTLE SET

ITEM	DESCRIPTION	UOM	CASE
MPS-42W	4-1/2"Dia Bowl	Set	1/12

### MORTAR & PESTLE



MPS-42W

## STAINLESS STEEL MIXING BOWLS



MXHV-500



MXBH-500



MXBT-500Q



MXB-500Q



MXRU-SERIES



MXBS-30

## HEAVY-DUTY MIXING BOWLS

ITEM	DESCRIPTION	SIZE (DIA X DEPTH)	UOM	CASE
MXHV-75	3/4 Qt	6-1/4" x 1-3/4"	Each	12/72
MXHV-150	1-1/2 Qt	7-3/4" x 2-1/4"	Each	12/36
MXHV-300	3 Qt	9-7/8" x 3"	Each	12/24
MXHV-400	4 Qt	10-5/8" x 3-1/4"	Each	12/24
MXHV-500	5 Qt	11-5/8" x 3-3/8"	Each	6/12
MXHV-800	8 Qt	13-3/4" x 5"	Each	6/12
MXHV-1300	13 Qt	16-1/4" x 4-1/2"	Each	12
MXHV-1600	16 Qt	17-3/4" x 5-1/2"	Each	12
MXHV-2000	20 Qt	18-3/4" x 5"	Each	12

## DEEP MIXING BOWLS

ITEM	DESCRIPTION	SIZE (DIA X DEPTH)	UOM	CASE
MXBH-300	3 Qt	9" x 3-1/2"	Each	12/48
MXBH-500	5 Qt	10-1/4" x 4-1/2"	Each	12/36
MXBH-800	8 Qt	12" x 5"	Each	12/24
MXBH-1300	13 Qt	15" x 5-3/4"	Each	12

## ALL-PURPOSE MIXING BOWLS

◆ True capacity for all-purpose kitchen prep work

ITEM	DESCRIPTION	SIZE (DIA X DEPTH)	UOM	CASE
MXBT-75Q	3/4 Qt	6-3/8" x 2-3/8"	Each	12/144
MXBT-150Q	1-1/2 Qt	7-7/8" x 2-7/8"	Each	12/144
MXBT-300Q	3 Qt	10-1/4" x 3-5/8"	Each	12/72
MXBT-400Q	4 Qt	11" x 3-3/4"	Each	12/72
MXBT-500Q	5 Qt	11-7/8" x 4"	Each	12/72
MXBT-800Q	8 Qt	13-3/4" x 5"	Each	12/36
MXBT-1300Q	13 Qt	16-3/8" x 5-7/8"	Each	12/24
MXBT-1600Q	16 Qt	17-7/8" x 6"	Each	12
MXBT-2000Q	20 Qt	19" x 6-5/8"	Each	12

## ECONOMY MIXING BOWLS

ITEM	DESCRIPTION	SIZE (DIA X DEPTH)	UOM	CASE
MXB-75Q	3/4 Qt	6-1/4" x 1-3/4"	Each	12/144
MXB-150Q	1-1/2 Qt	7-3/4" x 2-1/2"	Each	12/144
MXB-300Q	3 Qt	9-1/2" x 3-1/2"	Each	12/72
MXB-400Q	4 Qt	10-5/8" x 3-1/2"	Each	12/72
MXB-500Q	5 Qt	11-1/2" x 3-1/2"	Each	12/72
MXB-800Q	8 Qt	13-1/4" x 4-1/8"	Each	12/36
MXB-1300Q	13 Qt	16" x 4-1/2"	Each	24
MXB-1600Q	16 Qt	17-3/4" x 5"	Each	12
MXB-2000Q	20 Qt	18-5/8" x 5-1/2"	Each	12
MXB-3000Q	30 Qt	22-1/2" x 7-1/2"	Each	12

## SILICONE BASE MIXING BOWLS

◆ Non-skid silicone base helps to keep bowl in place during mixing and prepping

ITEM	DESCRIPTION	SIZE (DIA X DEPTH)	UOM	CASE
MXRU-150	1-1/2 Qt	6-3/4" x 3-3/4"	Each	48
MXRU-300	3 Qt	8-1/2" x 4-3/8"	Each	24
MXRU-500	5 Qt	10-1/4" x 5-5/8"	Each	24
MXRU-800	8 Qt	11-3/4" x 6-1/2"	Each	6/12

## MIXING BOWL STAND

ITEM	DESCRIPTION	UOM	CASE
MXBS-30	Stand for MXB-3000Q	Set	1
MXBS-30-C	Caster for MXBS-30	Each	4/24



### HEAVY-DUTY COLANDERS WITH HANDLES AND BASE

- ◆ Premium quality stainless steel; extra heavy-duty weight
- ◆ Ideal for rinsing large fruits/vegetables, straining potatoes, or draining pastas or meats
- ◆ Tapered, high-wall cone shape
- ◆ Holes sized to keep food in but allow water to flow freely
- ◆ Durable, sturdy, easy to transport between prep stations

ITEM	DESCRIPTION	SIZE (DIA X DEPTH)	UOM	CASE
SLO-11	11 Qt	15" x 7-1/2"	Each	1
SLO-16	16 Qt	16-1/2" x 7-1/2"	Each	1

## COLANDERS



SLO-16

### ALL-PURPOSE COLANDERS WITH HANDLES AND BASE

- ◆ Stainless steel
- ◆ Tapered sides, sturdy rounded handles, footed base

ITEM	DESCRIPTION	SIZE (DIA X DEPTH)	UOM	CASE
COD-3	3 Qt	10" x 4"	Each	12/48
COD-5	5 Qt	11-5/8" x 4"	Each	24
COD-8	8 Qt	13-1/4" x 5-1/8"	Each	12
COD-14	14 Qt	16-1/4" x 5-7/8"	Each	12



COD-3

### CHINESE-STYLE COLANDERS

- ◆ Stainless steel
- ◆ Wide, smooth-edge rim for safe and secure grip
- ◆ Coarse = 5mm diameter drain holes
- ◆ Fine = 2-1/2mm diameter drain holes

ITEM	DESCRIPTION	SIZE (DIA X DEPTH)	UOM	CASE
CCOD-11L	5-1/4 Qt, Coarse	11-3/4" x 4"	Each	24
CCOD-13L	9 Qt, Coarse	14-1/8" x 4-3/4"	Each	24
CCOD-15L	13-3/4 Qt, Coarse	16-3/8" x 5-1/8"	Each	12
CCOD-11S	5-1/4 Qt, Fine	12" x 4"	Each	24
CCOD-13S	9 Qt, Fine	15" x 4-1/2"	Each	24
CCOD-15S	13-3/4 Qt, Fine	16-3/8" x 5-1/2"	Each	12



CCOD-15L



CCOD-11S

### COLANDERS WITH HANDLES AND BASE

- ◆ Aluminum
- ◆ Riveted handles for added strength and easy transport
- ◆ Flat and sturdy footed base for raised draining

ITEM	DESCRIPTION	SIZE (DIA X DEPTH)	UOM	CASE
ALO-8BH	8 Qt	12" x 5"	Each	6
ALO-11BH	11 Qt	15" x 5-3/4"	Each	6
ALO-16BH	16 Qt	16-1/2" x 7-1/8"	Each	4



ALO-16BH

### COLANDERS WITHOUT BASE

- ◆ Aluminum
- ◆ Traditional tapered sides

ITEM	DESCRIPTION	SIZE (DIA X DEPTH)	UOM	CASE
ALO-12	12 Qt	13-1/2" x 5-1/2"	Each	12
ALO-16	16 Qt	16" x 8"	Each	12
ALO-16H	16 Qt	16-1/8" x 8"	Each	6



ALO-12



ALO-16H



## BUTTER ROLLER



SPBR-604

## BUTTER ROLLER

- ◆ Standard 1/6 size steam table pan, fits into 7"L x 6-3/8"W size opening
- ◆ Reduces butter and dressing waste
- ◆ Roller is removable for easy cleaning
- ◆ Spreads butter quickly and evenly
- ◆ Sturdy stainless steel construction
- ◆ Designed for countertop access
- ◆ Provides safe and sanitary food preparation

ITEM	DESCRIPTION	UOM	CASE
SPBR-604	7"L x 6-3/8"W	Each	1/6

## BATTER DISPENSERS



APCD-6



APCD-6 & APCD-6R

## ALUMINUM PANCAKE DISPENSER

- ◆ Durable plunger ensures consistent amounts of batter every time
- ◆ Eight portion-control settings ranging from 1/2 oz to 8 oz
- ◆ 10 gauge high-grade aluminum body
- ◆ Parts are durable, long-lasting, and prevent clogs and leaking

ITEM	DESCRIPTION	UOM	CASE
APCD-6	Pancake Dispenser	Each	1/6
APCD-6R	Rack for APCD-6	Each	12/48



APCD-6R



STN-3

## PANCAKE TURNER

- ◆ Heat resistant up to 608°F (320°C)
- ◆ Nylon blade
- ◆ 18/8 stainless steel handle

ITEM	DESCRIPTION	UOM	CASE
STN-3	15-7/16"L x 5-15/16"W x 2-13/16"H	Each	24/48



SF-7



SF-7 & SF-7R



SF-7R

## CONFECTIONERY FUNNEL

- ◆ Use to dispense a smooth flow of fondant, syrup or prepared creams
- ◆ Spring valve feature allows for easy control with single-handed operation
- ◆ Comes with three (3) nozzles: 4mm, 5mm, 6mm
- ◆ Rack sold separately

ITEM	DESCRIPTION	UOM	CASE
SF-7	Funnel, S/S	Each	1/8
SF-7R	Rack for SF-7, S/S	Each	1/24

## UTILITY PAIL



UP-13

## UTILITY PAIL

- ◆ Stainless steel

ITEM	DESCRIPTION	UOM	CASE
UP-13	13 Qt	Each	12



TMT-SERIES  
as indicated



TMT-DG5



TMT-DG1



TMT-IF1



TMT-DG6



TMT-DG2



TMT-WD1



TMT-DG4

## DIGITAL

- ◆ Protective sleeve included
- ◆ Excellent, quick response times for fast temperature readings

ITEM	NSF	TEMPERATURE RANGE	LCD	PROBE	GUIDELINE ON DIAL	MOUNTING / OTHER FEATURES	UOM	CASE
TMT-DG1		-40° - 302°F; -40° - 150°C	1"	4-3/4"L	Meat Cooking Temperature Guide		Each	12/144
TMT-DG2	N/A	-49° - 392°F; -45° - 200°C	1-3/16"	4-3/4"L	Meat Cooking Temperature Guide	• Easy-Read LCD Head Swivels 180°	Each	12/72
TMT-DG4		-40° - 450°F; -40° - 230°C	1-1/4"	3-1/8"L	HACCP	• Hold Function	Each	3/144
TMT-DG5	N/A	-49° - 392°F; -45° - 200°C	1-3/8" Back-Lit	2-7/8"L	Meat Cooking Temperature Guide	• Min. & Max. Feature • Hold Function • Hanging String	Each	12/72
TMT-DG6	N/A	-58 - 572°F; -50 - 300°C	1-7/8"	6"L		• Flip-Down Stand • Magnet Included	Set	24/96

## WATERPROOF DIGITAL THERMOMETERS

- ◆ Compact pen-style thermometers provide fast temperature readings for liquids or solids
- ◆ Minimum & maximum hold feature

ITEM	NSF	TEMPERATURE RANGE	LCD	PROBE	GUIDELINE ON DIAL	MOUNTING / OTHER FEATURES	UOM	CASE
TMT-WD1		-58° - 392°F; -50° - 200°C	7/8"	2-3/4"L		• Hold Function • Protective Sleeve	Each	24/96

## INFRARED THERMOMETER

- ◆ Simply point infrared light at surface for accurate temperature reading of all kinds of cooked or baked goods, without the risk of cross-contamination.
- ◆ 20 second automatic power off
- ◆ Distance to spot ratio 12:1

ITEM	NSF	TEMPERATURE RANGE	LCD	PROBE	GUIDELINE ON DIAL	MOUNTING / OTHER FEATURES	UOM	CASE
TMT-IF1	N/A	-26° - 608°F; -32° - 320°C	1" Back-Lit	N/A		• Auto temp. hold • Laser ON/OFF	Each	12/48



# THERMOMETERS

**NSF** TMT-SERIES  
as indicated



**NEW**

AVAILABLE IN  
AUGUST 2020



TMT-HH1



TMT-P2



TMT-MT2



TMT-P1



TMT-P3



TMT-MT3



TMT-OV2



TMT-OV3



TMT-GS2



TMT-IR1

## HOT HOLDING

◆ Hang or stand-alone

ITEM	NSF	TEMPERATURE RANGE	DIAL FACE	GUIDELINE ON DIAL	UOM	CASE
TMT-HH1		100° - 180°F; 38° - 82°C	2" Dia	HACCP	Each	12/96

## POCKET TEST

◆ Includes protective sleeve with built-in clip

◆ Recalibrate for accuracy

ITEM	NSF	TEMPERATURE RANGE	DIAL FACE	PROBE	GUIDELINE ON DIAL	UOM	CASE
TMT-P1		0 - 220°F; -18 - 104°C	1" Dia	5"L	HACCP	Each	12/72
TMT-P2		-40 - 180°F; -40 - 80°C	1" Dia	5"L	HACCP	Each	12/72
TMT-P3		50 - 550°F; 10 - 288°C	1" Dia	5"L	HACCP	Each	12/144

## MEAT

◆ Hand held with adjustable indicator

ITEM	NSF	TEMPERATURE RANGE	DIAL FACE	PROBE	GUIDELINE ON DIAL	UOM	CASE
TMT-MT2		130 - 190°F; 55 - 85°C	2" Dia	5"L	HACCP	Each	12/144
TMT-MT3		130 - 190°F; 55 - 85°C	3" Dia	5"L	HACCP	Each	12/72

## OVEN

◆ Hanging hook and standing panel are built-in

ITEM	NSF	TEMPERATURE RANGE	DIAL FACE	GUIDELINE ON DIAL	UOM	CASE
TMT-OV2		40 - 500°F; 10 - 260°C	2" Dia	HACCP	Each	12/144
TMT-OV3		40 - 500°F; 10 - 260°C	3" Dia	HACCP	Each	12/144

## GRILL FACE

◆ Flat surface for grill-top

ITEM	NSF	TEMPERATURE RANGE	DIAL FACE	UOM	CASE
TMT-GS2		150 - 700°F; 70 - 370°C	2" Dia	Each	3/144

## INSTANT READ

◆ Includes protective sleeve with built-in clip

◆ Can be calibrated

ITEM	NSF	TEMPERATURE RANGE	DIAL FACE	PROBE	GUIDELINE ON DIAL	UOM	CASE
TMT-IR1		0 - 220°F; -18 - 104°C	1-3/4" Dia	5"L	HACCP	Each	12/72

# THERMOMETERS

TMT-SERIES as indicated   



TMT-FT1



TMT-IO1

**NEW**

**AVAILABLE IN AUGUST 2020**



TMT-CDF4



TMT-CDF5



TMT-CDF3



TMT-CDF2



TMT-RF4



TMT-RF3



TMT-RF2



TMT-RF1



## FROTHING

- ◆ Includes pot clip
- ◆ Recalibrate for accuracy





ITEM	NSF	TEMPERATURE RANGE	DIAL FACE	PROBE	OC AVAILABLE	UOM	CASE
TMT-FT1		0-220°F -18-104°C	1" Dia	5"L	Optional	Each	12/144

## CANDY/DEEP FRYER

- ◆ Includes pot clip

ITEM	NSF	TEMPERATURE RANGE	DIAL FACE	PROBE	GUIDELINE ON DIAL	OTHER FEATURES	UOM	CASE
TMT-CDF2		100-400°F; 40-200°C	2" Dia	5"L	HACCP	• Adjustable Indicator • Recalibratable	Each	12/144
TMT-CDF3		100-400°F; 40-200°C	2" Dia	12"L	HACCP	• Adjustable Indicator • Recalibratable	Each	12/144
TMT-CDF4	N/A	100-400°F; 40-200°C	2" x 11-3/4"	N/A	N/A	• Top Hanging • Vertical Read	Each	12/72
TMT-CDF5		100-500°F; 40-260°C	3" Dia	12"L	HACCP	• Adjustable Indicator • Recalibratable	Each	6/36

## REFRIGERATOR/FREEZER

ITEM	NSF	TEMPERATURE RANGE	DIAL FACE	GUIDELINE ON DIAL	MOUNTING	UOM	CASE
TMT-RF1		-26-86°F; -30-30°C	2-7/8" x 5/8"	N/A	Suction Cup Included	Pack	12/144
TMT-RF2		-20-70°F; -30-21°C	2" Dia	HACCP	Built-in Hanging Hook & Standing Panel	Each	12/72
TMT-RF3		-20-70°F; -30-21°C	3" Dia	HACCP	Built-in Hanging Hook & Standing Panel	Each	12/72
TMT-RF4		-20-80°F; -28-26°C	3-1/2" x 1-1/8"	HACCP	Suction Cup Included	Each	12/72

## INDOOR / OUTDOOR

- ◆ Weather resistant, rust proof
- ◆ Install with hanging hook or double-sided adhesive (included)

ITEM	NSF	TEMPERATURE RANGE	DIAL FACE	GUIDELINE ON DIAL	MOUNTING	UOM	CASE
TMT-IO1	N/A	-40° - 120°F; -40° - 50°C	1-3/4" Dia	N/A	Built-in Hanging Hook or double-sided adhesive	Each	12/144

## STATIK BOARD™ CUTTING BOARDS

# STATIKboard™



NSF

BPA FREE

CBN-610WT



EDGES OF THE NON-SLIP FEET HELP PREVENT BOARDS FROM SLIDING WHEN STORED UPRIGHT WITHOUT RACKS



Available colors

NSF

BPA FREE

CBN-SERIES

IMPROVED DESIGN



### STATIK BOARD™ GARNISH CUTTING BOARD

*Like its larger counterpart, the garnish cutting board features the same molded-through non-slip feet that hold firm, even when wet. The tough surface reduces knife dulling and durable copolymer material prevents warping.*

- ◆ Dishwasher safe
- ◆ NSF Listed

ITEM	DESCRIPTION	COLOR	UOM	CASE
CBN-610WT	6" x 10" x 1/2"	White	Each	20



### STATIK BOARD™ CUTTING BOARDS

*The patented original design of STATIK BOARD™ puts safety first with molded-through, non-slip feet that prevent slipping & sliding, even on wet countertops. Rubberized sides of the board help maintain an upright storage position without sliding. They hold firm, are sturdy, and the fully-rubberized hook makes them easy to store and transport.*

- ◆ Built-in hook for easy transport and hygienic storage
- ◆ Rubberized feet grip flat surfaces; rubberized sides keep the board upright without sliding
- ◆ Available in three (3) popular sizes
- ◆ HACCP color-coding system to minimize cross-contact
- ◆ Tough board surface reduces knife dulling; durable copolymer prevents warping
- ◆ Dishwasher safe
- ◆ NSF listed

ITEM	DESCRIPTION	COLOR	UOM	CASE
CBN-1218BN	12" x 18" x 1/2"	Brown	Each	6
CBN-1218BU	12" x 18" x 1/2"	Blue	Each	6
CBN-1218GR	12" x 18" x 1/2"	Green	Each	6
CBN-1218PP	12" x 18" x 1/2"	Purple	Each	6
CBN-1218RD	12" x 18" x 1/2"	Red	Each	6
CBN-1218WT	12" x 18" x 1/2"	White	Each	6
CBN-1218YL	12" x 18" x 1/2"	Yellow	Each	6
CBN-1520BN	15" x 20" x 1/2"	Brown	Each	6
CBN-1520BU	15" x 20" x 1/2"	Blue	Each	6
CBN-1520GR	15" x 20" x 1/2"	Green	Each	6
CBN-1520PP	15" x 20" x 1/2"	Purple	Each	6
CBN-1520RD	15" x 20" x 1/2"	Red	Each	6
CBN-1520WT	15" x 20" x 1/2"	White	Each	6
CBN-1520YL	15" x 20" x 1/2"	Yellow	Each	6
CBN-1824BN	18" x 24" x 1/2"	Brown	Each	6
CBN-1824BU	18" x 24" x 1/2"	Blue	Each	6
CBN-1824GR	18" x 24" x 1/2"	Green	Each	6
CBN-1824PP	18" x 24" x 1/2"	Purple	Each	6
CBN-1824RD	18" x 24" x 1/2"	Red	Each	6
CBN-1824WT	18" x 24" x 1/2"	White	Each	6
CBN-1824YL	18" x 24" x 1/2"	Yellow	Each	6



## STATIK BOARD™ CUTTING BOARDS

The patented original design of STATIK BOARD™ puts safety first with molded-through, non-slip feet that prevent slipping & sliding, even on wet countertops. Rubberized sides of the board help maintain an upright storage position without sliding. They hold firm, are sturdy, and the fully-rubberized hook makes them easy to store and transport.

- ◆ Built-in hook for easy transport and hygienic storage
- ◆ Rubberized feet grip flat surfaces; rubberized sides keep the board upright without sliding
- ◆ Available in three (3) popular sizes
- ◆ HACCP color-coding system to minimize cross-contact
- ◆ Tough board surface reduces knife dulling; durable co-polymer prevents warping
- ◆ Dishwasher safe
- ◆ NSF listed

ITEM	DESCRIPTION	COLOR	UOM	CASE
CBK-1218BN	12" x 18" x 1/2"	Brown	Each	6
CBK-1218BU	12" x 18" x 1/2"	Blue	Each	6
CBK-1218GR	12" x 18" x 1/2"	Green	Each	6
CBK-1218RD	12" x 18" x 1/2"	Red	Each	6
CBK-1218YL	12" x 18" x 1/2"	Yellow	Each	6
CBK-1520BN	15" x 20" x 1/2"	Brown	Each	6
CBK-1520BU	15" x 20" x 1/2"	Blue	Each	6
CBK-1520GR	15" x 20" x 1/2"	Green	Each	6
CBK-1520RD	15" x 20" x 1/2"	Red	Each	6
CBK-1520YL	15" x 20" x 1/2"	Yellow	Each	6
CBK-1824BN	18" x 24" x 1/2"	Brown	Each	6
CBK-1824BU	18" x 24" x 1/2"	Blue	Each	6
CBK-1824GR	18" x 24" x 1/2"	Green	Each	6
CBK-1824RD	18" x 24" x 1/2"	Red	Each	6
CBK-1824YL	18" x 24" x 1/2"	Yellow	Each	6

## STATIK BOARD™ CUTTING BOARDS

# STATIKboard™



**SAME GREAT BOARD IN FULL COLOR**



Available colors

EDGES OF THE NON-SLIP FEET HELP PREVENT BOARDS FROM SLIDING WHEN STORED UPRIGHT WITHOUT RACKS

NSF  
BPA FREE  
CBK-SERIES

## CUTTING BOARDS



Boards shown with CB-6L rack

NSF

BPA FREE

CBWT-SERIES



CBI-1520

NSF

BPA FREE

CBI-SERIES



## WHITE RECTANGULAR CUTTING BOARDS

◆ NSF listed

ITEM	DESCRIPTION	UOM	CASE
CBWT-610	6" x 10" x 1/2"	Each	20
CBWT-1218	12" x 18" x 1/2"	Each	6
CBWT-1520	15" x 20" x 1/2"	Each	6
CBWT-1824	18" x 24" x 1/2"	Each	6
CBWT-1830	18" x 30" x 1/2"	Each	6
CBH-1218	12" x 18" x 3/4"	Each	6
CBH-1520	15" x 20" x 3/4"	Each	6
CBH-1824	18" x 24" x 3/4"	Each	6
CBXH-1218	12" x 18" x 1"	Each	4
CBXH-1520	15" x 20" x 1"	Each	4
CBXH-1824	18" x 24" x 1"	Each	4



## WHITE GROOVED CUTTING BOARDS

◆ Higher efficiency in food prep without worrying about juice spillage

◆ NSF listed

ITEM	DESCRIPTION	UOM	CASE
CBI-1218	12" x 18" x 1/2"	Each	6
CBI-1520	15" x 20" x 1/2"	Each	6
CBI-1824	18" x 24" x 1/2"	Each	6
CBI-1824H	18" x 24" x 3/4"	Each	6

## CUTTING BOARD RACKS



### CUTTING BOARD RACKS

◆ Fits cutting boards up to 1" thick

ITEM	DESCRIPTION	UOM	CASE
CB-6L	6 Slots, Chrome Plated	Each	6/12
CB-6K	6 Slots, Vinyl Coated	Each	10

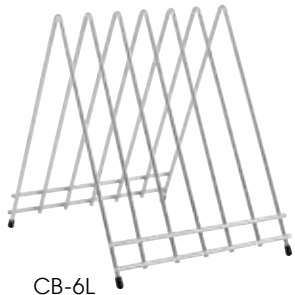

CB-6L



CB-6K

## CLEANING BRUSHES



### VEGETABLE CLEANING BRUSH

- ◆ Rigid polyester bristles effectively remove dirt and impurities from vegetable skins
- ◆ Circular opening surrounds cucumbers, carrots or zucchini for thorough, all-around cleaning
- ◆ Comfortable, easy-grip ergonomic handle
- ◆ Includes built-in hole for convenient hanging storage

ITEM	DESCRIPTION	COLOR	UOM	CASE
BRV-10	9-1/4"L x 4-3/4"W, Plastic Handle	White	Each	12/48



NEW

BPA FREE

BRV-10



### BOTTLE CLEANING BRUSH

- ◆ Ergonomic handle helps to reduce strain when washing bottles, glasses, pitchers or carafes
- ◆ Soft, durable polyester bristles effectively remove residue without scratching
- ◆ Easily reaches into narrow bottle necks and inner corners
- ◆ Includes built-in hole for convenient hanging storage

ITEM	DESCRIPTION	COLOR	UOM	CASE
BRB-12	12"L x 2-3/4" Dia, Plastic Handle	White	Each	12/48



NEW

BPA FREE

BRB-12



New Item

## HACCP COLOR-CODED CUTTING BOARDS

◆ NSF listed

ITEM	DESCRIPTION	COLOR	UOM	CASE
CBBN-1218	12" x 18" x 1/2"	Brown	Each	6
CBBU-1218	12" x 18" x 1/2"	Blue	Each	6
CBGR-1218	12" x 18" x 1/2"	Green	Each	6
CBRD-1218	12" x 18" x 1/2"	Red	Each	6
CBYL-1218	12" x 18" x 1/2"	Yellow	Each	6
CBBN-1520	15" x 20" x 1/2"	Brown	Each	6
CBBU-1520	15" x 20" x 1/2"	Blue	Each	6
CBGR-1520	15" x 20" x 1/2"	Green	Each	6
CBRD-1520	15" x 20" x 1/2"	Red	Each	6
CBYL-1520	15" x 20" x 1/2"	Yellow	Each	6
CBBN-1824	18" x 24" x 1/2"	Brown	Each	6
CBBU-1824	18" x 24" x 1/2"	Blue	Each	6
CBGR-1824	18" x 24" x 1/2"	Green	Each	6
CBRD-1824	18" x 24" x 1/2"	Red	Each	6
CBYL-1824	18" x 24" x 1/2"	Yellow	Each	6

## HACCP COLOR-CODED CUTTING BOARDS & MATS



COLORED CUTTING BOARDS

NSF

BPA FREE

## HACCP COLOR-CODED FLEXIBLE CUTTING MATS

- ◆ Mat flexes to easily transport food to cookware or storage
- ◆ Safe, easy to clean and complies with color coding standards for food preparation hygiene
- ◆ Made of 1/16" thick polyethylene; will not crack or chip
- ◆ Six (6) assorted colors included in set
- ◆ NSF listed

ITEM	DESCRIPTION	COLOR	UOM	CASE
CBF-1218	12" x 18"	Assorted	Set	12
CBF-1520	15" x 20"	Assorted	Set	12
CBF-1824	18" x 24"	Assorted	Set	6

Keep away from open flame.  
Do not put hot pans on top of mats.  
Wash with warm soapy water.



CBF-SERIES

NSF

BPA FREE

## HACCP COLOR-CODED CUTTING BOARD SETS

- ◆ Six (6) assorted colors included in set
- ◆ NSF listed

ITEM	DESCRIPTION	COLOR	UOM	CASE
CBST-1218	12" x 18" x 1/2"	Assorted	Set	1
CBST-1520	15" x 20" x 1/2"	Assorted	Set	1
CBST-1824	18" x 24" x 1/2"	Assorted	Set	1

STANDARD COLOR CODING SYSTEM		
Raw Meats	Raw Poultry	Vegetable & Fruit
Bakery & Dairy	Cooked Meats	Seafood



CBST-SERIES

NSF

BPA FREE

## HACCP COLOR-CODED BRUSHES

ITEM	DESCRIPTION	COLOR	UOM	CASE
CBR-WT	6-1/2"L x 2-1/2"W	White	Each	24/96
CBR-BN	6-1/2"L x 2-1/2"W	Brown	Each	24/96
CBR-BU	6-1/2"L x 2-1/2"W	Blue	Each	24/96
CBR-GR	6-1/2"L x 2-1/2"W	Green	Each	24/96
CBR-RD	6-1/2"L x 2-1/2"W	Red	Each	24/96
CBR-YL	6-1/2"L x 2-1/2"W	Yellow	Each	24/96

## CUTTING BOARD CLEANING BRUSHES



CBR-SERIES

## WOODEN CUTTING BOARDS



WCB-1824



WCB-2016



Non-skid elevated feet

### WOODEN CARVING BOARD WITH CHANNEL

*This solid, natural birch wood carving board features a perimeter channel to catch excess juices and scraps from freshly carved meats. Wooden feet elevate the board off the work surface allowing for easy movability. Ideal for back of house prep as well as front of house carving stations and presentations.*

- ◆ Wider channel on one side catches larger scraps
- ◆ Non-skid rubber feet hold board steady while in use
- ◆ Hand wash, do not submerge in water

ITEM	DESCRIPTION	UOM	CASE
WCB-2016	20" x 16" x 1"	Each	4



Wider channel on one side to catch larger scraps

### WOODEN CUTTING/SERVING BOARDS

- ◆ Hand wash

ITEM	DESCRIPTION	UOM	CASE
WCB-125	12" x 5" x 3/4"	Each	24
WCB-225	22-1/2"L x 5-1/2"W x 3/4"H	Each	12



WCB-125



WCB-225



WCB-125 with KCS-6



# Avoiding Cross-Contact

Equip your kitchen for allergen safety & prevent cross-contact, with our **PURPLE Allergen-Free** tools.



Winco offers a complete line of tools to implement an allergen-free or gluten-free program in your establishment.

All items are **purple** in color, which easily identifies them for **"allergen-free"** use in the kitchen, preventing cross-contamination and enabling you to honor guests' dietary requirements.

ALLERGEN-FREE KITCHEN TOOLS



SBS-21PP



NSF PDS-7P



DSC-2P



NSF PSH-SERIES

PSH-16P

STATIKboard™

IMPROVED DESIGN

NSF CBN-1824PP

BPA FREE CUTTING BOARDS



CBN-1824PP

CBPP-1218



PECC-128P, PECC-68P, PECC-24P



AFP-10HP



UTPH-9P



BFM-A100



ALLERGEN-FREE PURPLE SILICONE BAKING MATS

- ◆ Double-sided and reusable up to 2,000 times
- ◆ Provides consistent and even heat distribution
- ◆ Woven fiberglass coated with food-grade silicone
- ◆ Temperature tolerance from -40°F to 480°F

ITEM	DESCRIPTION	SIZE	UOM	CASE
SBS-11PP	1/4-Size	8-1/4" x 11-3/4"	Each	20/100
SBS-16PP	1/2-Size	11-5/8" x 16-1/2"	Each	10/50
SBS-21PP	2/3-Size	14-7/16" x 20-1/2"	Each	10/50
SBS-24PP	Full-Size	16-3/8" x 24-1/2"	Each	10/50



ALLERGEN-FREE DOUGH SCRAPERS

ITEM	DESCRIPTION	SIZE	UOM	CASE
DSC-2P	Dough Scraper, Plstc Hdl, S/S Blade	6" x 3"	Each	12/72
PDS-7P	Plastic Dough Scrapers, 6-Pcs/Pk	7-1/2" x 4-3/4"	Pack	24/48

ALLERGEN-FREE COLOR CODED SCRAPER

- ◆ Features raised ridges for resting to prevent messy counters
- ◆ Heat-resistant up to 600°F (315°C)
- ◆ NSF listed

ITEM	DESCRIPTION	UOM	CASE
PSH-10P	10-1/2"	Each	24/144
PSH-14P	14"	Each	24/144
PSH-16P	16-1/4"	Each	24/144



ALLERGEN-FREE CUTTING BOARDS

- ◆ Tough board surface reduces knife dulling; durable co-polymer prevents warping
- ◆ Dishwasher safe
- ◆ NSF listed

ITEM	DESCRIPTION	COLOR	UOM	CASE
CBN-1218PP	12" x 18" x 1/2"	Purple	Each	6
CBN-1520PP	15" x 20" x 1/2"	Purple	Each	6
CBN-1824PP	18" x 24" x 1/2"	Purple	Each	6
CBPP-1218	12" x 18" x 1/2"	Purple	Each	6

ALLERGEN-FREE COVERS

- ◆ Compatible with PCSC, PTSC, and PESG Series

ITEM	DESCRIPTION	COLOR	UOM	CASE
PECC-24P	Fits 2 Qt & 4 Qt	Purple	Each	12
PECC-68P	Fits 6 Qt & 8 Qt	Purple	Each	12
PECC-128P	Fits 12 Qt, 18 Qt, 22 Qt	Purple	Each	6

ALLERGEN-FREE SILICONE SLEEVE

ITEM	DESCRIPTION	COLOR	UOM	CASE
AFP-10HP	Fits AFP-10, ASFP-11, ASP-3, -4	Purple	Each	1/120



ALLERGEN-FREE BAMBOO FOOD MARKERS

- ◆ Label and organize dishes that contain no allergens
- ◆ Each pack contains 100 pieces

ITEM	DESCRIPTION	UOM	CASE
BFM-A100	Food Markers	Pack	20/200

ALLERGEN-FREE STAINLESS STEEL UTILITY TONGS

- ◆ Non-slip comfort grip PP handle, heat resistant up to 220°F
- ◆ Made in Korea

ITEM	DESCRIPTION	UOM	CASE
UTPH-9P	9"	Each	6/72
UTPH-12P	12"	Each	6/72
UTPH-16P	16"	Each	6/72

**ALLERGEN-FREE STAINLESS STEEL ONE-PIECE LADLES**

ITEM	DESCRIPTION	HANDLE	UOM	CASE
LDC-2P	2 Oz	12-1/2"	Each	12/120
LDC-4P	4 Oz	15-1/2"	Each	12/120
LDC-6P	6 Oz	15-1/2"	Each	12/120

**ALLERGEN-FREE KITCHEN TOOLS**



**ALLERGEN-FREE STAINLESS STEEL ONE-PIECE PORTIONERS**

ITEM	DESCRIPTION	UOM	CASE
FPS-2P	2 Oz, Solid	Each	12/72
FPS-4P	4 Oz, Solid	Each	12/72
FPS-6P	6 Oz, Solid	Each	12/72
FPP-2P	2 Oz, Perforated	Each	12/72
FPP-4P	4 Oz, Perforated	Each	12/72
FPP-6P	6 Oz, Perforated	Each	12/72



**ALLERGEN-FREE STAINLESS STEEL DISHERS**

◆ NSF listed

ITEM	DESCRIPTION	SIZE	UOM	CASE
ICD-10P	3-3/4 Oz, 2-5/8"Dia	10"	Each	1/36
ICD-12P	3-1/4 Oz, 2-1/2"Dia	12"	Each	1/36
ICD-16P	2-3/4 Oz, 2-1/4"Dia	16"	Each	1/36
ICD-20P	2 Oz, 2-1/8"Dia	20"	Each	1/36

ICD-SERIES **NSF**

**ALLERGEN-FREE STAINLESS STEEL TURNERS & SPATULAS**

- ◆ Ergonomic handle with slip-free grip reduces hand fatigue
- ◆ Satin finish
- ◆ NSF listed

ITEM	DESCRIPTION	BLADE	UOM	CASE
TWP-31P	Sandwich Spreader	3-5/8" x 1-1/4"	Each	12/144
TWP-42P	Turner, Offset	8" x 4"	Each	12/48
TWP-51P	Pie Server, Offset *	4-5/8" x 2-3/8"	Each	12/72
TWP-60P	Fish Spatula	6-3/4" x 3-1/4"	Each	12/144
TWP-61P	Hamburger Turner, Offset*	5-1/8" x 2-7/8"	Each	12/72
TWP-90P	Flexible Turner, Offset*	8-1/4" x 2-7/8"	Each	12/48
TWP-91P	Perf Flex Turner, Offset*	8-1/4" x 2-7/8"	Each	12/48
TWPO-9P	Spatula, Offset*	8-1/2" x 1-1/2"	Each	12/72
TWPS-9P	Bakery Spatula	10" x 1-3/8"	Each	12/72

\*Measurement reflects blade size not including offset

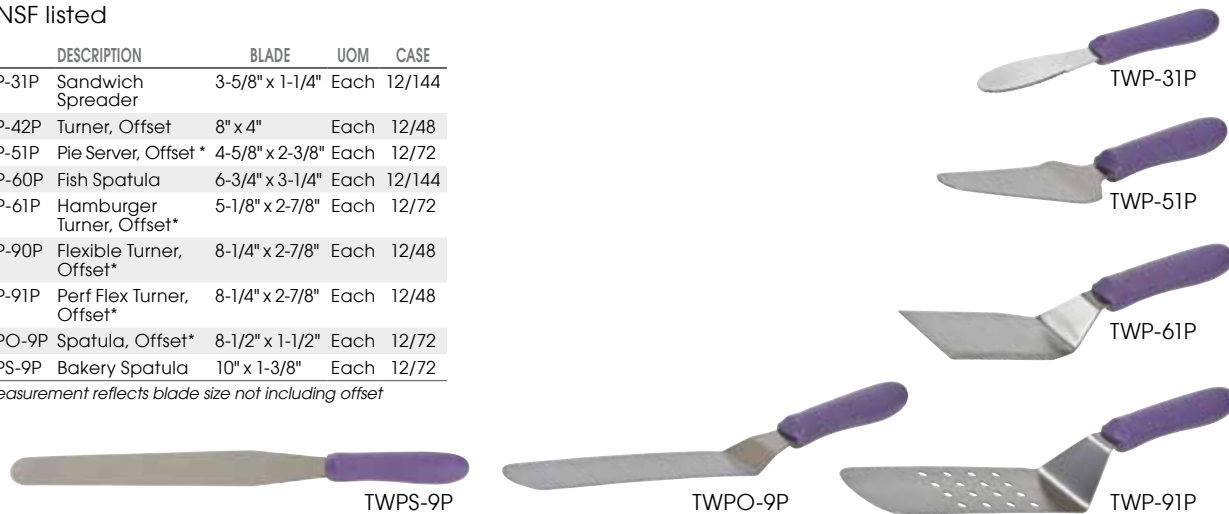

TWP, TWPO & TWPS-SERIES **NSF**

**ALLERGEN-FREE KNIVES**

- ◆ Razor-sharp blade constructed of X50 Cr MoV15 German steel
- ◆ Slip-free grip ergonomic PP handle reduces hand fatigue
- ◆ Protective finger guard
- ◆ Easy edge maintenance and rapid sharpening
- ◆ NSF listed

ITEM	DESCRIPTION	BLADE	UOM	CASE
KWP-30P	Paring Knife, 2-Pcs/Pk	3-1/4" L	Pack	6/36
KWP-80P	Chef's Knife	8" L	Each	6/36
KWP-91P	Bread Knife, Curved	9-1/2" L	Each	6/36
KWP-100P	Chef's Knife	10" L	Each	6/36
KWP-121P	Slicer, Wavy Edge	12" L	Each	6/36



KWP-SERIES **NSF**

## WHIPPED CREAM DISPENSER



CW-A05



### WHIPPED CREAM DISPENSER

*Whip up freshly-made creams, rich mousse, syrups, foam and more to top off inspired creations.*

- ◆ Includes three (3) decorating tips to create unique dessert and beverage presentations, and a brush to easily clean them
- ◆ Capacity: 1 Pint (0.5L)
- ◆ Fits standard 8gm N2O cartridge (*not included*), and compatible with all brands of whipped cream chargers/cartridges
- ◆ Durable aluminum bottle and stainless steel handle
- ◆ Hand-wash only

ITEM	DESCRIPTION	SIZE	UOM	CASE
CW-A05	Whipped Cream Dispenser w/3 Tips & 1 Brush	3" Dia x 12"H	Each	1/12
CW-P	3 Tips & 1 Cleaning Brush		Set	1
CW-PG	Replacement Gasket, 3-Pcs/Pk		Pack	1

**CARTRIDGE NOT INCLUDED**

**BPA FREE**

THREE (3) DECORATING TIPS

## PLATING MOLDS



SPM-23R



SPM-21R



SPM-31R



SPM-31O



SPM-41O



SPM-211T



SPM-22S



SPM-275S



### STAINLESS STEEL CULINARY PLATING MOLDS

*Perfect for baking, freezing, cutting and forming, these ring molds are extremely versatile kitchen tools. Create attractive plate presentations by layering salads and grains, or bake individual cake and pastry portions without waste.*

- ◆ Polished smooth to a brilliant mirror finish
- ◆ Dishwasher safe

ITEM	DESCRIPTION	UOM	CASE
SPM-21R	Round, 2"Dia x 1-3/4"H	Each	12/72
SPM-23R	Round, 2"Dia x 3"H	Each	12/72
SPM-31R	Round, 3"Dia x 1-3/4"H	Each	12/72
SPM-31O	Oval, 3"L x 1-3/8"H	Each	12/72
SPM-41O	Oval, 4"L x 1-3/8"H	Each	12/72
SPM-22S	Square, 2"L x 2"W x 2"H	Each	12/72
SPM-275S	Square, 2-3/4"L x 2-3/4"W x 2-3/4"H	Each	12/72
SPM-211T	Rectangular, 2-1/2"L x 1-3/4"W x 1-3/4"H	Each	12/72



### 18/8 STAINLESS STEEL PLATING TOOLS SET

All-in-one set includes five (5) plating tools and convenient carry bag.

- ◆ Spoons and tongs are dishwasher safe

ITEM	DESCRIPTION	UOM	CASE
PTK-6SET	6-Pc Set	Set	12/36

Set Includes:

- ◆ 8" Drizzling Spoon (SPS-TS8)
- ◆ 8" Solid Slanted Spoon (SPS-S8)
- ◆ 8" Perforated Slanted Spoon (SPS-P8)
- ◆ 8" Curved Tongs (TTG-8C)
- ◆ 8" Straight Tongs (TTG-8S)
- ◆ Carry Bag



### PLATING TOOLS SET



PTK-6SET

- ◆ Ideal for plating dessert, sauces, chocolate and more
- ◆ 18/8 stainless steel with satin finish
- ◆ Comfortable handle
- ◆ Dishwasher safe

### PLATING SPOONS

#### 18/8 STAINLESS STEEL DRIZZLING SPOON

Easily create stylish and artistic plated foods with our tapered spout drizzling spoons. The tapered end allows for drizzle control and the deep bowl reduces the need to refill.

- ◆ Tapered spout

ITEM	DESCRIPTION	UOM	CASE
SPS-TS8	8" Drizzling w/ Tapered Spout	Each	6/72



SPS-TS8

#### 18/8 STAINLESS STEEL PLATING SPOONS

Maintain excellent control in creating stylish presentations with these flat-front plating spoons, available w/ either a solid or perforated spoon bowl.

- ◆ Flat head

ITEM	DESCRIPTION	UOM	CASE
SPS-S8	8" Slanted, Solid	Each	6/72
SPS-S10	10" Slanted, Solid	Each	6/72
SPS-P8	8" Slanted, Perforated	Each	6/72
SPS-P10	10" Slanted, Perforated	Each	6/72



SPS-S8

SPS-P8

#### 18/8 STAINLESS STEEL PLATING TONGS

Plating tongs are the discerning chef's ideal tool, providing a controlled, gentle grasp of delicate garnishes for masterful placement and presentation.

- ◆ Dishwasher safe

ITEM	DESCRIPTION	UOM	CASE
TTG-8C	8" Curved	Each	24/144
TTG-10C	10" Curved	Each	24/144
TTG-8S	8" Straight	Each	24/144
TTG-10S	10" Straight	Each	24/144

### PLATING TONGS

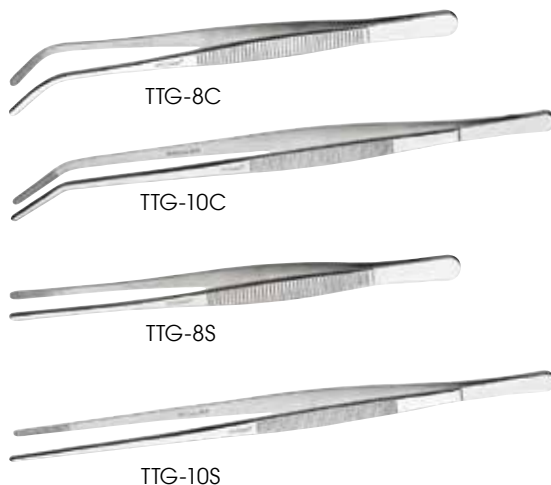

TTG-8C

TTG-10C

TTG-8S

TTG-10S





## Step up to Winco® Prime – A Cut Above

Winco Prime products are made with industry approved materials that comply with or exceed accepted industry standards. All products in the Winco Prime family are NSF® listed to give a comfort level that every effort has been made to provide a safe and durable product at an affordable price. Winco Prime products are safe to be used and will hold up well in the most demanding food service environment!

### NSF® BAIN-MARIES

### NSF® INSETS



BAMN-6



BAMN-6C



INSN-7



INSC-7M

#### WINCO® PRIME BAIN-MARIES

◆ Stainless steel satin finish

ITEM	DESCRIPTION	SIZE	UOM	CASE
BAMN-1.25	1.25 Qt	5" x 6"	Each	6/48
BAMN-1.5	1.5 Qt	5-1/2" x 5-1/4"	Each	6/48
BAMN-2	2 Qt	5-3/4" x 7"	Each	6/48
BAMN-3.5	3.5 Qt	7-1/4" x 7"	Each	6/36
BAMN-4.25	4.25 Qt	7-1/4" x 7-3/4"	Each	6/36
BAMN-6	6 Qt	8" x 8-3/4"	Each	6/24
BAMN-8.25	8.25 Qt	9" x 9-3/4"	Each	6/24
BAMN-12	12 Qt	10" x 10-1/2"	Each	6/12

#### BAIN-MARIE COVERS

◆ Stainless steel satin finish

ITEM	DESCRIPTION	UOM	CASE
BAMN-1.25C	Cover for BAMN-1.25	Each	12/144
BAMN-1.5C	Cover for BAMN-1.5	Each	12/144
BAMN-2C	Cover for BAMN-2	Each	12/144
BAMN-3.5C	Cover for BAMN-3.5	Each	12/144
BAMN-4.25C	Cover for BAMN-4.25	Each	12/72
BAMN-6C	Cover for BAMN-6	Each	12/72
BAMN-8.25C	Cover for BAMN-8.25	Each	12/48
BAMN-12C	Cover for BAMN-12	Each	12/24

#### WINCO® PRIME INSET PANS

◆ Stainless steel satin finish

ITEM	DESCRIPTION	SIZE	UOM	CASE
INSN-2.5	2.5 Qt	6" x 7-1/2"	Each	6/36
INSN-4	4 Qt	7-1/2" x 7-1/2"	Each	6/36
INSN-7	7 Qt	9-1/2" x 8"	Each	6/24
INSN-11	11 Qt	11-1/2" x 9"	Each	6/12

#### INSET COVERS (NON-NSF)

◆ Stainless steel mirror finish

ITEM	DESCRIPTION	UOM	CASE
INSC-2.5	Cover for INSN-2.5	Each	6/72
INSC-4	Cover for INSN-4	Each	6/36
INSC-7M	Cover for INSN-7	Each	6/48
INSC-11M	Cover for INSN-11	Each	6/36



Step up to Winco® Prime – A Cut Above

WINCO® PRIME

LADLES NSF®



LDCN-SERIES

LDCN-SERIES

LDIN-SERIES

**ONE-PIECE COLOR-CODED HANDLE LADLES**

- ◆ Color-coded for portion control
- ◆ Color matched with Winco Prime™ portioners
- ◆ 1.2mm thick stainless steel

ITEM	DESCRIPTION	COLOR	UOM	CASE
LDCN-1	1 Oz	Black	Each	12/72
LDCN-2	2 Oz	Blue	Each	12/72
LDCN-3	3 Oz	Tan	Each	12/72
LDCN-4	4 Oz	Gray	Each	12/72
LDCN-6	6 Oz	Green	Each	12/72
LDCN-8	8 Oz	Orange	Each	12/60

**ONE-PIECE BLACK HANDLE LADLES**

- ◆ 1.2mm thick stainless steel

ITEM	DESCRIPTION	UOM	CASE
LDCN-1	1 Oz	Each	12/72
LDCN-2K	2 Oz	Each	12/72
LDCN-3K	3 Oz	Each	12/72
LDCN-4K	4 Oz	Each	12/72
LDCN-6K	6 Oz	Each	12/72
LDCN-8K	8 Oz	Each	12/60

**ONE-PIECE STAINLESS STEEL LADLES**

- ◆ 1.0mm thick stainless steel

ITEM	DESCRIPTION	UOM	CASE
LDIN-0.5	0.5 Oz	Each	12/72
LDIN-0.75	0.75 Oz	Each	12/72
LDIN-1	1 Oz	Each	12/72
LDIN-1.5	1.5 Oz	Each	12/72
LDIN-2	2 Oz	Each	12/72
LDIN-3	3 Oz	Each	12/72
LDIN-4	4 Oz	Each	12/72
LDIN-5	5 Oz	Each	12/72
LDIN-6	6 Oz	Each	12/72
LDIN-8	8 Oz	Each	12/72
LDIN-12	12 Oz	Each	12/72



Step up to Winco® Prime – A Cut Above

**NSF** PORTIONERS



FPSN-SERIES



FPPN-SERIES

The Winco® Prime family of products are NSF® listed, an assurance that every effort has been made to provide a safe and durable product at an affordable price.

Count on Winco Prime, products made to endure in the most demanding food service environment!

**ONE-PIECE STAINLESS STEEL PORTION CONTROLLERS**

◆ 1.2mm thick stainless steel

ITEM	DESCRIPTION	STYLE	COLOR	UOM	CASE
FPSN-1	1 Oz	Solid	Black	Each	12/72
FPSN-2	2 Oz	Solid	Blue	Each	12/72
FPSN-3	3 Oz	Solid	Tan	Each	12/72
FPSN-4	4 Oz	Solid	Gray	Each	12/72
FPSN-6	6 Oz	Solid	Green	Each	12/72
FPSN-8	8 Oz	Solid	Orange	Each	12/72
FPPN-1	1 Oz	Perforated	Black	Each	12/72
FPPN-2	2 Oz	Perforated	Blue	Each	12/72
FPPN-3	3 Oz	Perforated	Tan	Each	12/72
FPPN-4	4 Oz	Perforated	Gray	Each	12/72
FPPN-6	6 Oz	Perforated	Green	Each	12/72
FPPN-8	8 Oz	Perforated	Orange	Each	12/72





Step up to Winco® Prime – A Cut Above

WINCO® PRIME

## BASTING SPOONS



BSON

BSPN

BSSN

BSON, BSPN, BSSN-SERIES



BHON

BHPN

BHSN

BHON, BHPN, BHSN-SERIES

### ONE-PIECE HEAVY-DUTY BASTING SPOONS

- ◆ 1.2mm thick stainless steel
- ◆ 18" and 21" spoons are 2.0mm stainless steel

ITEM	DESCRIPTION	HANDLE	UOM	CASE
BSON-11	11" Solid	11"	Each	12/72
BSON-13	13" Solid	13"	Each	12/72
BSON-15	15" Solid	15"	Each	12/72
BSON-18	18" Solid	18"	Each	12/72
BSON-21	21" Solid	21"	Each	12/72
BSPN-11	11" Perf'd	11"	Each	12/72
BSPN-13	13" Perf'd	13"	Each	12/72
BSPN-15	15" Perf'd	15"	Each	12/72
BSPN-18	18" Perf'd	18"	Each	12/72
BSSN-11	11" Slotted	11"	Each	12/72
BSSN-13	13" Slotted	13"	Each	12/72
BSSN-15	15" Slotted	15"	Each	12/72
BSSN-18	18" Slotted	18"	Each	12/72

### BASTING SPOONS WITH STOP-HOOK ABS HANDLE

- ◆ 1.2mm thick stainless steel

ITEM	DESCRIPTION	HANDLE	UOM	CASE
BHON-11	11" Solid	11"	Each	12/72
BHON-13	13" Solid	13"	Each	12/72
BHON-15	15" Solid	15"	Each	12/72
BHPN-11	11" Perf'd	11"	Each	12/72
BHPN-13	13" Perf'd	13"	Each	12/72
BHPN-15	15" Perf'd	15"	Each	12/72
BHSN-11	11" Slotted	11"	Each	12/72
BHSN-13	13" Slotted	13"	Each	12/72
BHSN-15	15" Slotted	15"	Each	12/72



DISHERS & PORTION SERVICE



NSF ICOP-SERIES



NSF ICD-SERIES



ISS-SERIES



AICD-12



ICS-1

ONE-PIECE DELUXE DISHERS

- ◆ Great for mashed potatoes, cookie dough and more
- ◆ Longer handle reduces hand and arm fatigue
- ◆ One-piece handle construction reinforced with stainless steel rod
- ◆ Long lasting durability
- ◆ Handle color indicates size of scoop
- ◆ Sturdy, durable 18/8 stainless steel
- ◆ NSF listed

ITEM	DESCRIPTION	DIA	SIZE	COLOR	UOM	CASE
ICOP-6	5-1/3 Oz	3-3/16"	6	White	Each	1/36
ICOP-8	4 Oz	2-7/8"	8	Gray	Each	1/36
ICOP-10	3-1/4 Oz	2-11/16"	10	Ivory	Each	1/36
ICOP-12	2-2/3 Oz	2-7/16"	12	Green	Each	1/36
ICOP-16	2 Oz	2-1/4"	16	Blue	Each	1/36
ICOP-20	1-5/8 Oz	2-1/8"	20	Yellow	Each	1/36
ICOP-24	1-1/3 Oz	2"	24	Red	Each	1/36
ICOP-30	1 Oz	1-13/16"	30	Black	Each	1/36
ICOP-40	3/4 Oz	1-5/8"	40	Purple	Each	1/36

DISHERS

- ◆ 18/8 stainless steel
- ◆ NSF listed

ITEM	DESCRIPTION	DIA	SIZE	COLOR	UOM	CASE
ICD-6	4-2/3 Oz	3"	6	White	Each	1/36
ICD-8	4 Oz	2-3/4"	8	Gray	Each	1/36
ICD-10	3-3/4 Oz	2-5/8"	10	Ivory	Each	1/36
ICD-12	3-1/4 Oz	2-1/2"	12	Green	Each	1/36
ICD-16	2-3/4 Oz	2-1/4"	16	Blue	Each	1/36
ICD-20	2 Oz	2-1/8"	20	Yellow	Each	1/36
ICD-24	1-3/4 Oz	2"	24	Red	Each	1/36
ICD-30	1-1/4 Oz	1-7/8"	30	Black	Each	1/36
ICD-40	7/8 Oz	1-5/8"	40	Purple	Each	1/36

SQUEEZE DISHERS/PORIONERS

- ◆ 18/8 stainless steel

ITEM	DESCRIPTION	DIA	SIZE	UOM	CASE
ISS-8	4 Oz	2-3/4"	8	Each	12/48
ISS-10	3-3/4 Oz	2-5/8"	10	Each	12/48
ISS-12	3-1/4 Oz	2-1/2"	12	Each	12/48
ISS-16	2-3/4 Oz	2-1/4"	16	Each	12/48
ISS-20	2-1/2 Oz	2-1/8"	20	Each	12/48
ISS-24	1-3/4 Oz	1-15/16"	24	Each	12/48
ISS-30	1-1/4 Oz	1-7/8"	30	Each	12/48
ISS-40	7/8 Oz	1-3/4"	40	Each	12/48
ISS-50	5/8 Oz	1-1/2"	50	Each	12/48
ISS-60	9/16 Oz	1-7/16"	60	Each	12/48
ISS-70	1/2 Oz	1-3/8"	70	Each	12/48
ISS-100	3/8 Oz	1-1/8"	100	Each	12/48

ICE CREAM DIPPERS, SELF-DEFROSTING

- ◆ Cast aluminum, hand wash only
- ◆ Contains non-toxic heat conductive fluid that enables dipper to self-defrost

ITEM	DESCRIPTION	SIZE	UOM	CASE
AICD-12	3 Oz	12	Each	12/144
AICD-16	2-1/2 Oz	16	Each	12/144
AICD-20	2 Oz	20	Each	12/144
AICD-24	1-1/2 Oz	24	Each	12/144

ICE CREAM SPADE

ITEM	DESCRIPTION	UOM	CASE
ICS-1	Ice Cream Spade	Each	12/120

**ONE-PIECE STAINLESS STEEL LADLES**

ITEM	DESCRIPTION	HANDLE	UOM	CASE
LDI-0	0.5 Oz	10-1/4"	Each	12/240
LDI-1	1 Oz	10-1/4"	Each	12/240
LDI-1.5	1.5 Oz	10-3/8"	Each	12/120
LDI-2	2 Oz	10-1/4"	Each	12/240
LDI-3	3 Oz	12"	Each	12/120
LDI-4	4 Oz	12-1/4"	Each	12/120
LDI-5	5 Oz	12-1/2"	Each	12/120
LDI-6	6 Oz	12-1/2"	Each	12/120
LDI-8	8 Oz	12-1/2"	Each	12/120
LDI-10	10 Oz	12-1/2"	Each	12/120
LDI-12	12 Oz	12-3/4"	Each	12/120
LDI-16	16 Oz	12-1/2"	Each	12/120
LDI-24	24 Oz	13"	Each	12/60

**TWO-PIECE STAINLESS STEEL LADLES**

ITEM	DESCRIPTION	HANDLE	UOM	CASE
LDT-1	1 Oz	12"	Each	12/120
LDT-32	32 Oz	16"	Each	12/60

**ONE-PIECE STAINLESS STEEL SHORT-HANDLE LADLES**

ITEM	DESCRIPTION	HANDLE	UOM	CASE
LDI-05SH	0.5 Oz	6"	Each	12/120
LDI-10SH	1 Oz	6"	Each	12/120
LDI-15SH	1.5 Oz	6"	Each	12/120
LDI-20SH	2 Oz	6"	Each	12/120
LDI-30SH	3 Oz	6"	Each	12/120
LDI-40SH	4 Oz	6"	Each	12/120
LDI-60SH	6 Oz	6"	Each	12/120

**ONE-PIECE STAINLESS STEEL COLOR-CODED LADLES**

ITEM	DESCRIPTION	COLOR	HANDLE	UOM	CASE
LDC-05	0.5 Oz	Aqua	12"	Each	12/120
LDC-1	1 Oz	yellow	12"	Each	12/120
LDC-2	2 Oz	Red	12-1/2"	Each	12/120
LDC-3	3 Oz	Ivory	13"	Each	12/120
LDC-4	4 Oz	Green	15-1/2"	Each	12/120
LDC-6	6 Oz	Black	15-1/2"	Each	12/120
LDC-8	8 Oz	Blue	16-1/2"	Each	12/60
LDC-12	12 Oz	Gray	16-1/2"	Each	12/60

**ONE-PIECE STAINLESS STEEL PORTIONERS**

ITEM	DESCRIPTION	STYLE	COLOR	UOM	CASE
FPS-1	1 Oz	Solid	Yellow	Each	12/72
FPS-2	2 Oz	Solid	Red	Each	12/72
FPS-3	3 Oz	Solid	Ivory	Each	12/72
FPS-4	4 Oz	Solid	Green	Each	12/72
FPS-6	6 Oz	Solid	Black	Each	12/72
FPS-8	8 Oz	Solid	Blue	Each	12/72
FPP-1	1 Oz	Perforated	Yellow	Each	12/72
FPP-2	2 Oz	Perforated	Red	Each	12/72
FPP-3	3 Oz	Perforated	Ivory	Each	12/72
FPP-4	4 Oz	Perforated	Green	Each	12/72
FPP-6	6 Oz	Perforated	Black	Each	12/72
FPP-8	8 Oz	Perforated	Blue	Each	12/72

**STAINLESS STEEL HOOKED-HANDLE DIPPER**

◆ Graduation marks visible on inside and outside of bowl

ITEM	DESCRIPTION	HANDLE	UOM	CASE
SHHD-1	1 Qt	12"	Each	12/48

**LADLES & PORTIONERS**



## UTILITY TONGS



UTPH-SERIES



UT-SERIES

**UT-SERIES TONGS  
FOR COLD FOOD  
SERVICE ONLY**



UT-9HT



UT-9



UT-9LT

### HEAT RESISTANT HEAVY-DUTY UTILITY TONGS

- ◆ Texturized non-slip PP handle for comfort and ease of use, heat resistant up to 220°F (104°C)
- ◆ Color-coded to help prevent cross-contamination in kitchen or buffet areas
- ◆ Made in Korea
- ◆ Stainless steel

ITEM	DESCRIPTION	COLOR	UOM	CASE
UTPH-9B	9"	Blue	Each	6/72
UTPH-9G	9"	Green	Each	6/72
UTPH-9K	9"	Black	Each	6/72
UTPH-9R	9"	Red	Each	6/72
UTPH-9Y	9"	Yellow	Each	6/72
UTPH-12B	12"	Blue	Each	6/72
UTPH-12G	12"	Green	Each	6/72
UTPH-12K	12"	Black	Each	6/72
UTPH-12R	12"	Red	Each	6/72
UTPH-12Y	12"	Yellow	Each	6/72
UTPH-16B	16"	Blue	Each	6/72
UTPH-16G	16"	Green	Each	6/72
UTPH-16K	16"	Black	Each	6/72
UTPH-16R	16"	Red	Each	6/72
UTPH-16Y	16"	Yellow	Each	6/72

### HEAVY-DUTY UTILITY TONGS WITH PLASTIC HANDLE

- ◆ For cold food service only
- ◆ Color-coded to help prevent cross-contact in the kitchen or buffet areas
- ◆ Stainless steel

ITEM	DESCRIPTION	COLOR	UOM	CASE
UT-9HP-B	9"	Blue	Each	12/72
UT-9HP-G	9"	Green	Each	12/72
UT-9HP-K	9"	Black	Each	12/72
UT-9HP-R	9"	Red	Each	12/72
UT-9HP-Y	9"	Yellow	Each	12/72
UT-12HP-B	12"	Blue	Each	12/72
UT-12HP-G	12"	Green	Each	12/72
UT-12HP-K	12"	Black	Each	12/72
UT-12HP-R	12"	Red	Each	12/72
UT-12HP-Y	12"	Yellow	Each	12/72
UT-16HP-B	16"	Blue	Each	12/72
UT-16HP-G	16"	Green	Each	12/72
UT-16HP-K	16"	Black	Each	12/72
UT-16HP-R	16"	Red	Each	12/72
UT-16HP-Y	16"	Yellow	Each	12/72

### EXTRA HEAVYWEIGHT UTILITY TONGS

- ◆ Coiled spring
- ◆ 1.2mm thick stainless steel

ITEM	DESCRIPTION	UOM	CASE
UT-9HT	9"	Each	12/72
UT-12HT	12"	Each	12/72
UT-16HT	16"	Each	12/72

### HEAVYWEIGHT UTILITY TONGS

- ◆ Coiled spring
- ◆ 0.9mm thick stainless steel

ITEM	DESCRIPTION	UOM	CASE
UT-7	7" (Specially designed for table service)	Each	12/72
UT-9	9"	Each	12/72
UT-12	12"	Each	12/72
UT-16	16"	Each	12/72

### MEDIUM-WEIGHT UTILITY TONGS

- ◆ Coiled spring
- ◆ 0.6mm thick stainless steel

ITEM	DESCRIPTION	UOM	CASE
UT-9LT	9"	Each	12/72
UT-12LT	12"	Each	12/72
UT-16LT	16"	Each	12/72

### HEAVY-DUTY BASTING SPOONS

◆ 2.0mm thick stainless steel

ITEM	DESCRIPTION	UOM	CASE
BHKS-21	21" Solid	Each	6/48
BHKP-21	21" Perforated	Each	6/48

### ONE-PIECE HEAVY-DUTY BASTING SPOONS

◆ 1.5mm thick stainless steel

ITEM	DESCRIPTION	UOM	CASE
BSOT-11H	11" Solid	Each	12/144
BSOT-13H	13" Solid	Each	12/144
BSOT-15H	15" Solid	Each	12/144
BSOT-18	18" Solid	Each	12/72
BSOT-21	21" Solid	Each	12/72
BSPT-11H	11" Perforated	Each	12/144
BSPT-13H	13" Perforated	Each	12/144
BSPT-15H	15" Perforated	Each	12/144
BSPT-18	18" Perforated	Each	12/72
BSST-11H	11" Slotted	Each	12/144
BSST-13H	13" Slotted	Each	12/144
BSST-15H	15" Slotted	Each	12/144
BSST-18	18" Slotted	Each	12/72

### BASTING SPOONS

◆ 1.2mm thick stainless steel

ITEM	DESCRIPTION	UOM	CASE
BSOT-11	11" Solid	Each	12/144
BSOT-13	13" Solid	Each	12/144
BSOT-15	15" Solid	Each	12/144
BSPT-11	11" Perforated	Each	12/144
BSPT-13	13" Perforated	Each	12/144
BSPT-15	15" Perforated	Each	12/144
BSST-11	11" Slotted	Each	12/144
BSST-13	13" Slotted	Each	12/144
BSST-15	15" Slotted	Each	12/144

### BASTING FORKS

◆ 1.5mm thick stainless steel

ITEM	DESCRIPTION	UOM	CASE
BSFK-18	18"	Each	12/72
BSFK-21	21"	Each	12/72
BHKF-21	21", 2.0mm thick	Each	6/48

### BASTING SPOONS WITH BAKELITE HANDLE

◆ 1.2mm thick stainless steel

ITEM	DESCRIPTION	UOM	CASE
BSOB-11	11" Solid	Each	12/72
BSOB-13	13" Solid	Each	12/72
BSOB-15	15" Solid	Each	12/72
BSPB-11	11" Perforated	Each	12/72
BSPB-13	13" Perforated	Each	12/72
BSPB-15	15" Perforated	Each	12/72
BSSB-11	11" Slotted	Each	12/72
BSSB-13	13" Slotted	Each	12/72
BSSB-15	15" Slotted	Each	12/72

### BASTING SPOONS WITH STOP-HOOK BAKELITE HANDLE

◆ 1.2mm thick stainless steel

ITEM	DESCRIPTION	UOM	CASE
BHOP-11	11" Solid	Each	12/120
BHOP-13	13" Solid	Each	12/120
BHOP-15	15" Solid	Each	12/120
BHPP-11	11" Perforated	Each	12/120
BHPP-13	13" Perforated	Each	12/120
BHPP-15	15" Perforated	Each	12/120
BHSP-11	11" Slotted	Each	12/120
BHSP-13	13" Slotted	Each	12/120
BHSP-15	15" Slotted	Each	12/120

## BASTING UTENSILS



SEE PAGE 303 FOR NSF LISTED UTENSILS

POLYCARBONATE SERVING UTENSILS

WITHSTANDS TEMPS FROM -40°F TO 212°F



NSF CVLD-SERIES

- ◆ Save money - the edges of Curv™ utensils get into tight corners and eliminate waste
- ◆ No dripping with contoured pouring spouts
- ◆ Molded-in stopper on spoon handles prevents slipping into pan/pot
- ◆ Textured exterior finish provides a secure grip
- ◆ Easy-clean smooth, high-gloss interior finish

**CURV™ ONE-PIECE DUAL SPOUT LADLES**

ITEM	DESCRIPTION	SIZE	UOM	CASE
CVLD-8C	Clear 3/4 oz	8-1/2"	Each	12/144
CVLD-8K	Black 3/4 oz	8-1/2"	Each	12/144
CVLD-8R	Red 3/4 oz	8-1/2"	Each	12/144
CVLD-13C	Clear 1 oz	13"	Each	12/144
CVLD-13K	Black 1 oz	13"	Each	12/144
CVLD-13R	Red 1 oz	13"	Each	12/144



NSF CVSS-SERIES & CVPS-SERIES

**CURV™ DUAL SPOUT SERVING SPOONS**

◆ 1-1/2 oz capacity

ITEM	DESCRIPTION	SIZE	UOM	CASE
CVSS-13C	Clear Solid	13"	Each	12/144
CVSS-13K	Black Solid	13"	Each	12/144
CVSS-13R	Red Solid	13"	Each	12/144
CVSS-15C	Clear Solid	15"	Each	12/144
CVSS-15K	Black Solid	15"	Each	12/144
CVSS-15R	Red Solid	15"	Each	12/144
CVPS-13C	Clear Perforated	13"	Each	12/144
CVPS-13K	Black Perforated	13"	Each	12/144
CVPS-13R	Red Perforated	13"	Each	12/144
CVPS-15C	Clear Perforated	15"	Each	12/144
CVPS-15K	Black Perforated	15"	Each	12/144
CVPS-15R	Red Perforated	15"	Each	12/144



NSF CVBS-SERIES

**CURV™ TAPERED BUFFET SPOONS**

◆ 3/4 oz capacity

ITEM	DESCRIPTION	SIZE	UOM	CASE
CVBS-10C	Clear	10"	Each	12/144
CVBS-10K	Black	10"	Each	12/144
CVBS-10R	Red	10"	Each	12/144

NSF CVST-SERIES

**CURV™ SERVING TONGS**

ITEM	DESCRIPTION	SIZE	UOM	CASE
CVST-6C	Clear	6"	Each	12/144
CVST-6K	Black	6"	Each	12/144
CVST-6R	Red	6"	Each	12/144
CVST-9C	Clear	9"	Each	12/144
CVST-9K	Black	9"	Each	12/144
CVST-9R	Red	9"	Each	12/144
CVST-12C	Clear	12"	Each	12/144
CVST-12K	Black	12"	Each	12/144
CVST-12R	Red	12"	Each	12/144

DURABLE AND FUNCTIONAL

**SPAGHETTI TONGS**

◆ Heat-resistant up to 302°F (150°C)

ITEM	DESCRIPTION	SIZE	UOM	CASE
PPT-11B	Beige	11"	Each	24/144
PPT-11C	Clear	11"	Each	24/144
PPT-11K	Black	11"	Each	24/144

NSF PPT-SERIES

**FLAT TONGS**

◆ Textured grip

ITEM	DESCRIPTION	SIZE	UOM	CASE
PUTF-6B	Beige	6"	Each	12/432
PUTF-6C	Clear	6"	Each	12/432
PUTF-6K	Black	6"	Each	12/432

NSF PUTF-SERIES

PUTF-6K

With a locking clip and non-slip silicone grip and tips, these utility tongs are made to use on non-stick coated pans to prevent scratching.

## LOCKING TONGS

### SILICONE GRIP UTILITY TONGS

- ◆ 0.6mm thick stainless steel
- ◆ Heat-resistant up to 400 °F (204°C)

ITEM	DESCRIPTION	UOM	CASE
UTS-9K	9"	Each	12/72
UTS-12K	12"	Each	12/72



### UTILITY TONGS

- ◆ 0.5mm thick stainless steel
- ◆ Locking ring and non-slip grip
- ◆ Heat-resistant up to 400 °F (204°C)

ITEM	DESCRIPTION	UOM	CASE
UT-7K	7"	Each	24/144



### HEAVYWEIGHT UTILITY TONGS WITH LOCKING RING

- ◆ Coil spring
- ◆ 0.9mm thick stainless steel

ITEM	DESCRIPTION	UOM	CASE
UTLK-7	7"	Each	12/72
UTLK-9	9"	Each	12/72
UTLK-12	12"	Each	12/72
UTLK-16	16"	Each	12/72



### SERVING TONGS

These heavyweight 18/8 satin finished stainless steel serving tongs are designed for comfortable service in elegant settings.

- ◆ Great for buffets, catered events and more
- ◆ Dishwasher safe

ITEM	DESCRIPTION	SIZE	UOM	CASE
STH-8	Short	8.5"	Each	12/72
STH-10	Medium	10.5"	Each	12/72
STH-13	Long	13.5"	Each	12/72

## STAINLESS STEEL SERVING TONGS

### SALAD TONGS

ITEM	DESCRIPTION	SIZE	UOM	CASE
PTOS-8	Oval, Satin Finish	7-3/4"	Each	12/96
ST-2	Double Spoon, Mirror Finish	10"	Each	6/60
ST-10	Fork and Spoon, Satin Finish	10"	Each	6/60
ST-10S	Slotted and Solid Spatula, Mirror Finish	10"	Each	12/96
ST-105SF	Spatula and Fork, Mirror Finish	10-1/2"	Each	12/96



### PASTRY TONGS

ITEM	DESCRIPTION	SIZE	UOM	CASE
PT-8	Solid with Short Handle	7-1/2"	Each	12/120
PT-875	Solid with Long Handle	8-3/4"	Each	12/144
PT-10P	Perforated	10-1/2"	Each	12/96

### SPAGHETTI TONGS

ITEM	DESCRIPTION	SIZE	UOM	CASE
ST-8	Mirror Finish	8"	Each	12/240

### ICE TONGS

ITEM	DESCRIPTION	SIZE	UOM	CASE
ICT-7	Five Prong, Textured	7"	Each	12/144
IT-7	Three Prong, Satin Finish	7"	Each	12/120

### POM TONGS

ITEM	DESCRIPTION	SIZE	UOM	CASE
PT-6	Satin Finish	6"	Doz	4/24
PT-9	Satin Finish	9"	Doz	4/24

## STAINLESS STEEL WHIPS

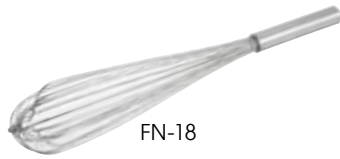
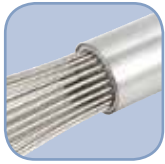

FN-18



PN-14



MWP-40

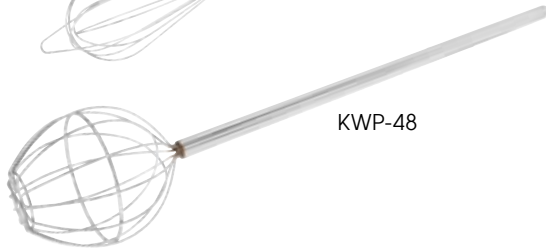

KWP-48



## FRENCH WHIPS

*This multi-purpose kitchen tool takes on the tougher mixing tasks for consistent results with every batch.*

- ◆ Durable stainless steel; sturdy wires & solid handle
- ◆ Ideal for whipping mashed potatoes, heavy batter or sauces, and more

ITEM	DESCRIPTION	UOM	CASE
FN-10	10"	Each	12/72
FN-12	12"	Each	12/72
FN-14	14"	Each	12/72
FN-16	16"	Each	12/60
FN-18	18"	Each	12/60
FN-20	20"	Each	12/60
FN-22	22"	Each	12/60
FN-24	24"	Each	12/60



## PIANO WHIPS

*The piano whip successfully mixes and aerates light custards, sauces and more.*

- ◆ Durable stainless steel; sturdy wires & solid handle
- ◆ Ideal for light creams, dressings or frosting

ITEM	DESCRIPTION	UOM	CASE
PN-10	10"	Each	12/72
PN-12	12"	Each	12/72
PN-14	14"	Each	12/72
PN-16	16"	Each	12/72
PN-18	18"	Each	12/72

## MAYONNAISE & KETTLE WHIPS

ITEM	DESCRIPTION	UOM	CASE
MWP-40	Mayonnaise Whip, 40"	Each	8
KWP-48	Kettle Whip, 48"	Each	8

## MASHERS



PTMP-24S



PTMP-18R



PTM-24R



PTM-18S



PR-9



PR-16

## POTATO MASHERS

*Our professional-quality mashers are nickel-plated, heavy-duty enough to be used for all root vegetables. The handles are chrome-plated for durability with a choice of polypropylene or wooden handles.*

### STEEL POTATO MASHERS W/PLASTIC SLEEVE GRIP

ITEM	DESCRIPTION	SIZE	UOM	CASE
PTMP-18R	4" Round	18" Handle	Each	6/12
PTMP-18S	4-1/2" Square	17-3/4" Handle	Each	6/12
PTMP-24R	5" Round	24-1/2" Handle	Each	6/12
PTMP-24S	5-1/4" Square	24" Handle	Each	6/12

### WOODEN HANDLE POTATO MASHERS

ITEM	DESCRIPTION	SIZE	UOM	CASE
PTM-18R	4" Round	18" Handle	Each	6/12
PTM-18S	4-1/2" Square	17-3/4" Handle	Each	6/12
PTM-24R	5" Round	24-1/2" Handle	Each	6/12
PTM-24S	5-1/4" Square	24" Handle	Each	6/12

## POTATO RICERS

- ◆ Stainless steel

ITEM	DESCRIPTION	UOM	CASE
PR-9	Economy, Round	Each	6
PR-16	Square	Each	1/6



**BLACK NYLON COOKING TOOLS**

These durable nylon cooking tools are available in a variety of options to cover all sorts of uses. Handy to have around the kitchen, they withstand high temps and won't scuff or scratch.

- ◆ Non-stick friendly
- ◆ Heat resistant up to 410°F (210°C)
- ◆ BPA-free

ITEM	DESCRIPTION	UOM	CASE
NC-WS	A. Slotted Spatula	Each	12/144
NC-SL2	B. Slotted Spoon	Each	12/144
NC-SS1	C. Solid Spoon	Each	12/144
NC-PF2	D. 2-Prong Fork	Each	12/144
NC-PS1	E. Pasta Fork	Each	12/144
NC-RS	F. Fish Spatula	Each	12/144
NC-LD	G. Ladle	Each	12/144
NC-MS	H. Masher	Each	12/144
NC-SK	I. Skimmer	Each	12/144
NC-WP	J. Whip	Each	12/144



**NYLON COOKING TOOLS**



NC-SERIES **BPA FREE**

**SILICONE BRUSH**

The perfect tool for brushing on marinades, oil or butter onto meats, fish or breads! This silicone brush won't scratch foods and is non-stick friendly.

- ◆ Non-stick friendly and easy to clean
- ◆ 100% silicone exterior; stainless steel interior
- ◆ Heat resistant up to 428°F (220°C)
- ◆ Dishwasher safe for easier cleanup
- ◆ BPA-free

ITEM	DESCRIPTION	UOM	CASE
SB-175R	1-3/4"W	Each	24/144

**SILICONE BRUSH**



SB-175R **BPA FREE**

MIXING PADDLES & SPOONS



MPD-24

MPD-36

WSP-24



NSP-10W

BPA FREE

NSP-SERIES



NS-15B

NS-15R

NS-15T

NS-15W

BPA FREE

NS-SERIES



WWP-SERIES

STAINLESS STEEL MIXING PADDLES

ITEM	DESCRIPTION	UOM	CASE
MPD-24	24"	Each	12
MPD-36	36"	Each	12
MPD-48	48"	Each	12
MPD-60	60"	Each	12

WOODEN STIRRING PADDLES

ITEM	DESCRIPTION	UOM	CASE
WSP-18	18"	Each	12/36
WSP-24	24"	Each	12/36
WSP-36	36"	Each	12/36
WSP-48	48"	Each	12/36



NYLON MIXING PADDLES

Mix, fold or spread anything from icing to batters with this nylon mixing paddle. The stain-resistant, sturdy one-piece construction is resistant to high temperatures, making it ideal for melting chocolate on hot stove tops.

- ◆ High temperature nylon is heat-resistant up to 400°F (204°C)
- ◆ BPA-free

ITEM	DESCRIPTION	UOM	CASE
NSP-10W	10"	Each	12/120
NSP-14W	14"	Each	12/120
NSP-20W	20"	Each	12/120



HIGH HEAT NYLON SPOONS

- ◆ Easy to clean one-piece construction
- ◆ Ideal for non-stick cookware; Stain resistant
- ◆ Heat resistant up to 400°F (204°C)
- ◆ BPA-free

ITEM	DESCRIPTION	UOM	CASE
NS-12B	12", Blue	Each	24/144
NS-12R	12", Red	Each	24/144
NS-12T	12", Tan	Each	24/144
NS-12W	12", Off-white	Each	24/144
NS-15B	15", Blue	Each	24/72
NS-15R	15", Red	Each	24/72
NS-15T	15", Tan	Each	24/72
NS-15W	15", Off-white	Each	24/72



WOODEN SPOONS

ITEM	DESCRIPTION	UOM	CASE
WWP-12	12"	Doz	1/8
WWP-14	14"	Doz	1/8
WWP-16	16"	Doz	1/8
WWP-18	18"	Doz	1/8

**ALLERGEN-FREE COLOR CODED SCRAPER**

Solve the challenges of maintaining an allergen-aware kitchen! Improve customer dining experiences while raising the bar for food safety. Prevent cross-contaminating allergens with the extensive line of Allergen-Free tools by Winco®. Whether it's gluten, nuts or more, use this stand-out purple color to designate these scrapers as allergen-free.

- ◆ Features raised ridges for resting to prevent messy counters
- ◆ Heat-resistant up to 600°F (315°C)
- ◆ NSF listed
- ◆ BPA-free

ITEM	DESCRIPTION	UOM	CASE
PSH-10P	10-1/2"	Each	24/144
PSH-14P	14"	Each	24/144
PSH-16P	16-1/4"	Each	24/144

**SILICONE SCRAPERS**

- ◆ Features raised ridges for resting to prevent messy counters
- ◆ Heat-resistant up to 600°F (315°C)
- ◆ NSF listed
- ◆ BPA-free

ITEM	DESCRIPTION	UOM	CASE
PSH-10	10-1/2"	Each	24/144
PSH-14	14"	Each	24/144
PSH-16	16-1/4"	Each	24/144

**BOWL-SHAPED SILICONE SCRAPERS**

- ◆ Heat-resistant up to 500°F (260°C)
- ◆ BPA-free

ITEM	DESCRIPTION	UOM	CASE
PSG-10	10"	Each	12/120
PSG-14	14"	Each	12/120
PSG-16	16"	Each	12/120

**ECONOMY SILICONE SCRAPERS**

- ◆ Heat-resistant up to 500°F (260°C)
- ◆ BPA-free

ITEM	DESCRIPTION	UOM	CASE
PSD-10	10"	Each	12/120
PSD-14	14"	Each	12/120
PSD-16	16"	Each	12/120

**BOWL-SHAPED PLASTIC SCRAPERS**

- ◆ BPA-free

ITEM	DESCRIPTION	UOM	CASE
PSGE-10	10"	Each	12/120
PSGE-14	14"	Each	12/72
PSGE-16	16"	Each	12/36

**PLASTIC SCRAPERS**

- ◆ NSF listed
- ◆ BPA-free

ITEM	DESCRIPTION	UOM	CASE
PSC-10	10"	Each	24/360
PSC-14	14"	Each	12/288
PSC-16	16"	Each	12/288

**SCRAPERS**

SEE PAGE 295 FOR MORE OF THE ALLERGEN-FREE LINE

**Allergen Free**

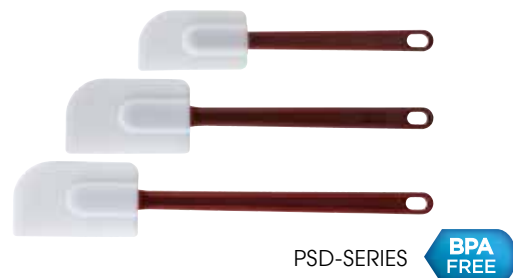
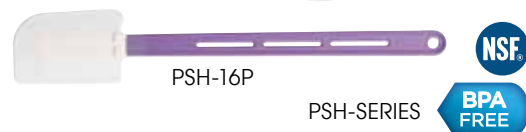

## MINI MEASURING LADLES



MSL-5S



MSL-11



## MINI MEASURING LADLES

Easily portion and serve smaller quantities with mini ladles in varying capacities.

- ◆ Ideal for either measuring or serving small quantities
- ◆ Durable 18/8 stainless steel construction
- ◆ Capacity stamped on each handle

ITEM	DESCRIPTION	UOM	CASE
MSL-5S	5-Pc Set: 1/8 Tsp, 1/4 Tsp, 1/2 Tsp, 1 Tsp, 1 Tbsp	Set	12/72
MSL-11	3/4 Tbsp	Each	60/300



## MEASURING SPOONS



MSP-4P



MSPD-4X



MSPP-4

BPA FREE

## STAINLESS STEEL MEASURING SPOON SETS

- ◆ Set includes: 1/4 Tsp, 1/2 Tsp, 1 Tsp, 1 Tbsp

ITEM	DESCRIPTION	UOM	CASE
MSP-4P	4-Pc Set	Set	12/288
MSPD-4X	Deluxe 4-Pc Set	Set	24/240



## PLASTIC MEASURING SPOON SET

- ◆ Set includes: 1/4 Tsp, 1/2 Tsp, 1 Tsp, 1 Tbsp
- ◆ BPA-free

ITEM	DESCRIPTION	UOM	CASE
MSPP-4	4-Pc Set	Set	12/216

## PLASTIC MEASURING CUPS



MCPP-4

BPA FREE



## PLASTIC MEASURING CUP SET

- ◆ Set includes: 1/4 Cup, 1/3 Cup, 1/2 Cup, 1 Cup
- ◆ BPA-free

ITEM	DESCRIPTION	UOM	CASE
MCP-4	4-Pc Set	Set	12/72

**STAINLESS STEEL MEASURING CUP SET**

◆ Set includes: 1/4 Cup, 1/3 Cup, 1/2 Cup, 1 Cup

ITEM	DESCRIPTION	UOM	CASE
MCP-4P	4-Pc Set	Set	12/48

**STAINLESS STEEL MEASURING CUPS**



MCP-4P

**ALUMINUM MEASURING CUPS**

ITEM	DESCRIPTION	UOM	CASE
AM-05	1/2 Qt	Each	1/48
AM-1	1 Qt	Each	1/36
AM-2	2 Qt	Each	1/36
AM-4	4 Qt	Each	1/24

**ALUMINUM MEASURING CUPS**



AM-2



**DELUXE MEASURING CUPS**

- ◆ Molded one-piece break-resistant polycarbonate
- ◆ Raised external markings in both quarts (red letters) and liters (blue letters)
- ◆ Tapered open handle for a secure grip; nesting
- ◆ Dishwasher safe

ITEM	DESCRIPTION	UOM	CASE
PMCP-25	1 Cup	Each	6/72
PMCP-50	1 Pint	Each	6/72
PMCP-100	1 Qt	Each	6/36
PMCP-200	2 Qt	Each	6/36
PMCP-400	4 Qt	Each	6/24
PMCP-5SET	Complete 5-Pc Set	Set	1/6

**POLYCARBONATE MEASURING CUPS**



PMCP-SERIES NSF

**MEASURING CUPS**

- ◆ Durable polycarbonate w/raised graduation markings
- ◆ NSF listed

ITEM	DESCRIPTION	UOM	CASE
PMU-25	1 Cup	Each	36
PMU-50	1 Pint	Each	36
PMU-100	1 Qt	Each	36
PMU-200	2 Qt	Each	36
PMU-400	4 Qt	Each	12



PMU-SERIES NSF



# SPATULAS & TURNERS

- ◆ Stainless steel, satin finish blade
- ◆ Ergonomic handle with slip-free comfort grip reduces hand fatigue
- ◆ Dishwasher safe
- ◆ NSF listed (TNH-Series)

**HIGH-QUALITY  
LOW COST**



DESCRIPTION	BLADE SIZE (LXW)	UOM	HIGH-HEAT ORANGE NYLON ERGO HANDLE		WOODEN HANDLE	
			ITEM	CASE	ITEM	CASE
Mini Turner	2" x 2-1/4"	* Each			TN32	12/120
Sandwich Spreader	3-5/8" x 1-1/4"	Each			TN713	12/144
Small Scraper	4-1/2" x 3-1/8"	Each			TN526	12/72
Large Scraper	4-7/8" x 4"	Each			TN54	12/72
Steak/Burger Turner	4-1/8" x 3-3/4"	* Each			TN46	12/72
Turner	8" x 4"	Each	TNH-42	12/48	TN48	12/24
Grill Spatula	4-1/4" x 2-3/16"	* Each			TN165	12/72
Teppanyaki Turner, Full Tang	4" x 3-1/2"	* Each			TN43	12/72
Pie Server	4-5/8" x 2-3/8"	* Each			TN166	12/72
Fish Spatula	6-3/4" x 3-1/4"	Each	TNH-60	12/144	FST-6	12/144
Hamburger Turner	5-1/8" x 2-7/8"	* Each	TNH-61	12/72	TN719	12/72
Extra Heavy Turner, Cutting Edge Blade	5" x 6"	* Each	TNH-63	12/48	TN56	12/48
Square Edge Turner	6-1/4" x 3"	* Each	TNH-64	12/72		
Square Edge Turner	7-1/4" x 3"	* Each	TNH-70	12/48		
Flexible Turner	8-1/4" x 2-7/8"	* Each	TNH-90	12/48	TN249	12/48
Flexible Turner (Perforated Blade)	8-1/4" x 2-7/8"	* Each	TNH-91	12/48	TN409	12/48
Offset Giant Turner	8-1/2" x 2-7/8"	* Each			TN44	12/48
Offset Spatula	3-1/2" x 3/4"	* Each			TOS-4	24/288
Offset Spatula	6-1/2" x 1-5/16"	* Each			TOS-7	12/144
Offset Spatula	8-1/2" x 1-1/2"	* Each			TOS-9	12/72
Bakery Spatula	4" x 3/4"	Each			TNS-4	24/288
Bakery Spatula	7-15/16" x 1-1/4"	Each			TNS-7	12/144
Bakery Spatula	10" x 1-3/8"	Each			TNS-9	12/72

\*Measurement reflects blade size not including offset

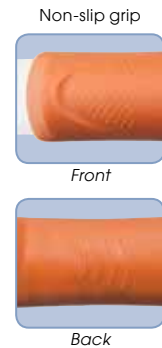
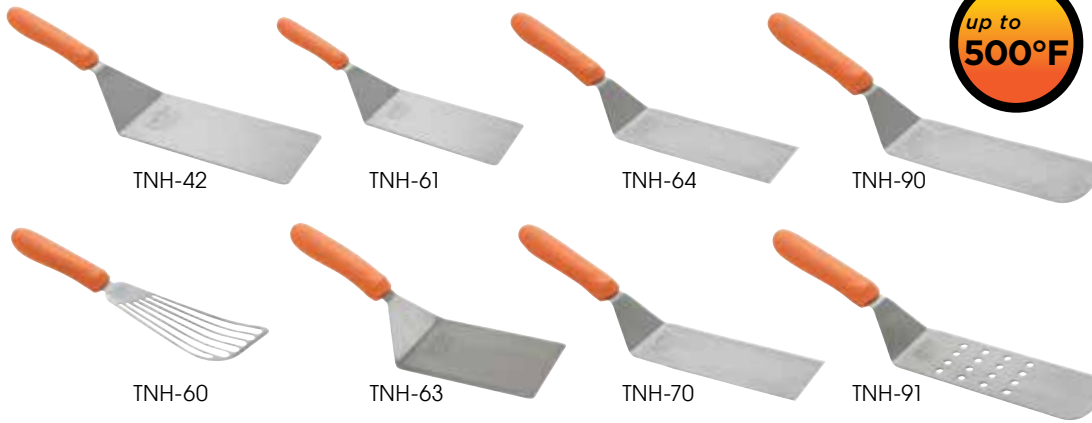

**NSF** TNH-SERIES (ORANGE)



Relative size comparisons shown

# SPATULAS & TURNERS

- ◆ Stainless steel, satin finish blade
- ◆ Ergonomic handle with slip-free comfort grip reduces hand fatigue
- ◆ Dishwasher safe
- ◆ NSF listed



DESCRIPTION	BLADE SIZE (L X W)	UOM	BLACK ERGO HANDLE		WHITE ERGO HANDLE	
			ITEM	CASE	ITEM	CASE
Mini Turner	2" x 2-1/4"	* Each	TKP-30	12/120	TWP-30	12/120
Sandwich Spreader	3-5/8" x 1-1/4"	Each	TKP-31	12/144	TWP-31	12/144
Small Scraper	4-1/2" x 3-1/8"	Each	TKP-32	12/72	TWP-32	12/72
Large Scraper	4-7/8" x 4"	Each	TKP-40	12/72	TWP-40	12/120
Steak/Burger Turner	4-1/8" x 3-3/4"	* Each	TKP-41	12/72	TWP-41	12/72
Turner	8" x 4"	Each	TKP-42	12/48	TWP-42	12/48
Grill Spatula	4-1/4" x 2-3/16"	* Each	TKP-50	12/72	TWP-50	12/72
Pie Server	4-5/8" x 2-3/8"	* Each	TKP-51	12/72	TWP-51	12/72
Fish Spatula	6-3/4" x 3-1/4"	Each	TKP-60	12/144	TWP-60	12/144
Hamburger Turner	5-1/8" x 2-7/8"	* Each	TKP-61	12/72	TWP-61	12/72
Extra Heavy Turner, Cutting Edge Blade	5" x 6"	* Each	TKP-63	12/48		
Flexible Turner	8-1/4" x 2-7/8"	* Each	TKP-90	12/72	TWP-90	12/48
Flexible Turner (Perforated Blade)	8-1/4" x 2-7/8"	* Each	TKP-91	12/72	TWP-91	12/48
Offset Spatula	3-1/2" x 3/4"	* Each	TKPO-4	24/288	TWPO-4	24/288
Offset Spatula	6-1/2" x 1-5/16"	* Each	TKPO-7	12/144	TWPO-7	12/144
Offset Spatula	8-1/2" x 1-1/2"	* Each	TKPO-9	12/144	TWPO-9	12/144
Bakery Spatula	4" x 3/4"	Each	TKPS-4	24/288	TWPS-4	24/288
Bakery Spatula	7-15/16" x 1-1/4"	Each	TKPS-7	12/144	TWPS-7	12/144
Bakery Spatula	10" x 1-3/8"	Each	TKPS-9	12/144	TWPS-9	12/72

\*Measurement reflects blade size not including offset



TKP-30



TKP-31



TKP-32



TKP-40



TKP-41



TKP-42



TKP-50



TKP-51



TKP-60



TKP-61



TKP-63



TKP-90



TKP-91



TKPO-9



TKPS-9

**Allergen Free**  
SEE PAGE 297 FOR ALLERGEN-FREE PURPLE HANDLE

TKP-SERIES (BLACK) **NSF**

TWP-SERIES (WHITE) **NSF**

## WINCO® SPREADER BULK PACK

Practical for many uses around the kitchen, the spreader is now available in bulk. Packed in a convenient display bucket for impulse purchase positioning.

- ◆ Assortment of seven (7) colors included in convenient display bucket
- ◆ 3-5/8" spreader with stainless steel, satin finish blade
- ◆ Slip-free comfort grip
- ◆ NSF listed

ITEM	DESCRIPTION	UOM	CASE
TWP-3135	35-Pcs/Pk	Pack	1/4

## WINCO® SPREADER BULK PACK



Includes 7 handle colors

TWP-3135 **NSF**



PASTA BASKETS



The Connoisseur premium pasta baskets are made of 18/8 stainless steel that is electro-polished for added corrosion resistance. The extra-heavyweight construction stands up to the constant knocking of its edges when removing pasta. The cylindrical design allows water to flow freely for even cooking and the handles have an open end for hang-drying. The baskets can be used with most pasta cooker machines and standard stock pots.

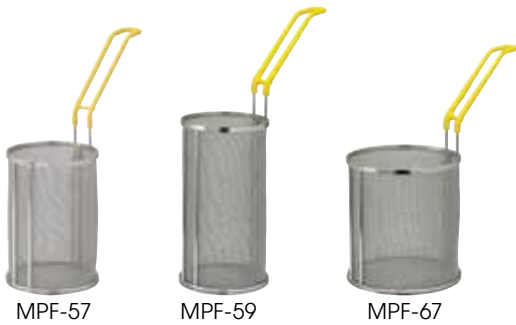

**SUPER FINE MESH CONNOISSEUR PASTA BASKETS**

- ◆ Designed specifically for fine pasta, such as capellini and linguine
- ◆ 18/8 stainless steel, with reinforced frame

ITEM	DESCRIPTION	UOM	CASE
MPF-57	5"Dia x 7"H, Short	Each	1/8
MPF-59	5"Dia x 9"H, Tall	Each	1/8
MPF-67	6-1/2"Dia x 7"H, Wide	Each	1/8

PASTA BOIL BASKETS



PASTA BOIL BASKETS

- ◆ 18/8 stainless steel frame and normal mesh makes it ideal for cooking capellini
- ◆ Fits standard pasta cookers and stock pots

ITEM	DESCRIPTION	UOM	CASE
MPN-57	5-1/4" Dia x 7"H, Short	Each	2/8
MPN-59	5" Dia x 9"H, Tall	Each	2/8
MPN-67	6-1/2" Dia x 7"H, Wide	Each	2/6

BULK PASTA BASKET

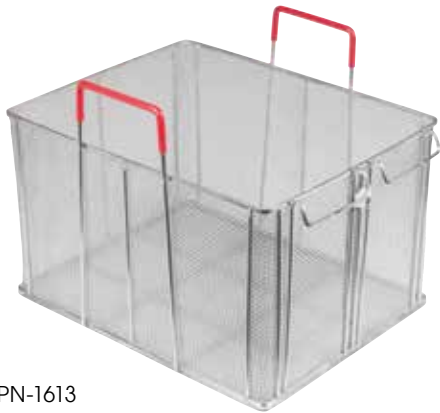

BULK PASTA/IMMERSION BASKET

- ◆ Durable 18/8 stainless steel
- ◆ Plastic coated handles rated for temperatures up to 250°F (120°C)
- ◆ Suitable for cooking most types of pasta in bulk
- ◆ Fits standard cookers

ITEM	DESCRIPTION	UOM	CASE
MPN-1613	16-1/4"L x 12-7/8"W x 10"H	Each	2



STRAINERS



**STAINLESS STEEL SPAGHETTI STRAINER**

- ◆ 18/8 stainless steel
- ◆ Tri-riveted handle with helper hook that rests over rim of pot

ITEM	DESCRIPTION	HANDLE	UOM	CASE
SSS-3	8-1/2"Dia	8"	Each	6/24

**ALUMINUM SPAGHETTI STRAINERS**

ITEM	DESCRIPTION	HANDLE	UOM	CASE
ASS-09	9"Dia	7-1/2"	Each	12
ASS-10	10"Dia	6-3/4"	Each	12



**SCOOP COLANDER**

Scoop and strain pasta or vegetables with the scoop colander. With its long handle, the scoop colander is ideal for easily lifting food out of pots, woks or friers.

- ◆ 18/8 stainless steel

ITEM	DESCRIPTION	UOM	CASE
CODS-7	7"L x 4"W, 11"L HdL	Each	4/16

**SCOOP COLANDER**



CODS-7



**HOLLOW HANDLE BOUILLON STRAINERS**

- ◆ Extra-fine mesh

ITEM	DESCRIPTION	UOM	CASE
CCB-8	8"	Each	1/6
CCB-8R	8", Reinforced	Each	1/6
CCB-10	10"	Each	6
CCB-10R	10", Reinforced	Each	6

**STAINLESS STEEL STRAINERS**



CCB-8



CCB-8R



CCS-10C



CCS-10F

**CHINA CAP STRAINERS, STAINLESS STEEL**

- ◆ Perforated 18/8 stainless steel with welded handle

ITEM	DESCRIPTION	UOM	CASE
CCS-8F	8" Fine	Each	12
CCS-10F	10" Fine	Each	12
CCS-12F	12" Fine	Each	12
CCS-8C	8" Coarse	Each	12
CCS-10C	10" Coarse	Each	12
CCS-12C	12" Coarse	Each	12

**CHINOIS PESTLE**

- ◆ Solid wood construction
- ◆ Press, crush and push mixtures through a bouillon strainer
- ◆ Fits standard size strainers

ITEM	DESCRIPTION	UOM	CASE
WPST-13	13-7/8"L x 3-1/8"Dia	Each	6/24

**WOODEN PESTLE**



WPST-13

## SKIMMERS



### STAINLESS STEEL HEAVY-DUTY SKIMMER

◆ One-piece construction

ITEM	DESCRIPTION	HANDLE	UOM	CASE
SCS-6H	6-1/4"Dia	16"	Each	12/72

### STAINLESS STEEL SKIMMERS

ITEM	DESCRIPTION	HANDLE	UOM	CASE
SCS-5	4-1/2"Dia	13"	Each	12/120
SCS-6	5-3/4"Dia	13-1/2"	Each	12/120

### EXTRA STRENGTH SHORT HANDLE SKIMMER

◆ Stainless steel

ITEM	DESCRIPTION	UOM	CASE
SC-12	12"Dia	Each	12/24

## WIRE SKIMMERS



### WIRE SKIMMERS

◆ Nickel plated

ITEM	DESCRIPTION	HANDLE	UOM	CASE
SC-5R	5"Dia	13"	Each	12/36
SC-6R	6"Dia	13"	Each	12/36
SC-7R	7"Dia	13"	Each	12/36
SC-8R	8"Dia	13"	Each	12/24
SC-9R	9"Dia	13"	Each	12/24
SC-12R	12"Dia	13"	Each	12/24

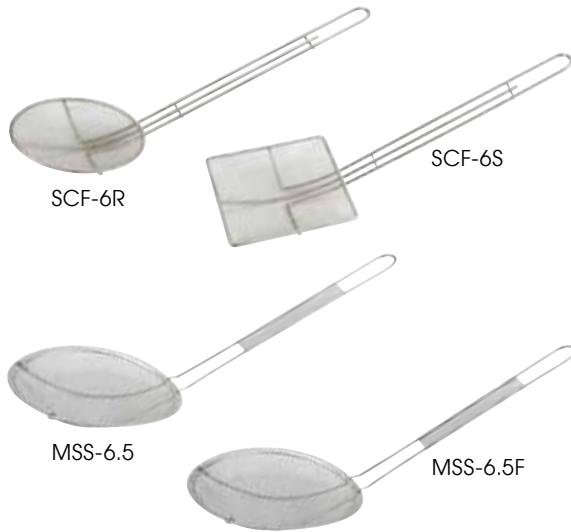

### SPIRAL SKIMMERS

◆ Nickel plated

ITEM	DESCRIPTION	HANDLE	UOM	CASE
SCF-7	7"Dia	14"	Each	12/48
SCF-9	9"Dia	14"	Each	12/48

### MESH SKIMMERS

◆ Nickel plated

ITEM	DESCRIPTION	HANDLE	UOM	CASE
SCF-6R	6-1/2"Dia	13"	Each	12/48
SCF-6S	6-3/4" x 6-3/4"	13"	Each	12/48

### STAINLESS STEEL SINGLE MESH SKIMMERS

ITEM	DESCRIPTION	HANDLE	UOM	CASE
MSS-6F	6"Dia, Fine	13"	Each	12/120
MSS-6.5F	6-1/2"Dia, Fine	13"	Each	12/120
MSS-6	6"Dia, Coarse	13"	Each	12/120
MSS-6.5	6-1/2"Dia, Coarse	13"	Each	12/120

## CULINARY BASKETS



### CULINARY BASKETS

◆ Nickel plated steel

ITEM	DESCRIPTION	DIA	UOM	CASE
MSB-08	Coarse Mesh	8"	Each	12/36
MSB-08M	Medium Mesh	8"	Each	12/36
MSB-08F	Fine Mesh	8"	Each	12/36
MSB-10	Coarse Mesh	10"	Each	12/36
MSB-10M	Medium Mesh	10"	Each	12/36
MSB-10F	Fine Mesh	10"	Each	12/36
MSB-12	Coarse Mesh	12"	Each	30
MSB-12M	Medium Mesh	12"	Each	30
MSB-12F	Fine Mesh	12"	Each	30



### REINFORCED DOUBLE MESH

◆ Nickel plated

ITEM	DESCRIPTION	DIA	UOM	CASE
MST-10RB	Flat Handle	10-1/2"	Each	12
MST-1010D	Round Handle	10-1/2"	Each	12
MST-12D	Round Handle	12"	Each	6
MST-14D	Round Handle	14"	Each	6

### FINE MESH STRAINERS

◆ Stainless steel

ITEM	DESCRIPTION	DIA	UOM	CASE
MS3A-8D	Double Mesh	8"	Each	12/48
MS3A-8S	Single Mesh	8"	Each	12/48
MS2K-10D	Double Mesh	10-1/2"	Each	12/48
MS2K-10S	Single Mesh	10-1/2"	Each	12/48

### TINNED DOUBLE MESH

ITEM	DESCRIPTION	DIA	UOM	CASE
MSTF-6D	Fine	6-1/4"	Each	12/96
MSTF-8D	Fine	8"	Each	12/48
MSTF-10D	Fine	10-1/4"	Each	12/24
MST-6D	Medium	6-1/4"	Each	12/96
MST-8D	Medium	8"	Each	12/48
MST-10D	Medium	10-1/2"	Each	12/24

### TINNED SINGLE MESH

ITEM	DESCRIPTION	DIA	UOM	CASE
MSTF-6S	Fine	6-1/4"	Each	12/96
MSTF-8S	Fine	8"	Each	12/48
MSTF-10S	Fine	10-1/4"	Each	12/24
MST-6S	Medium	6-1/4"	Each	12/96
MST-8S	Medium	8"	Each	12/48
MST-10S	Medium	10-1/4"	Each	12/24

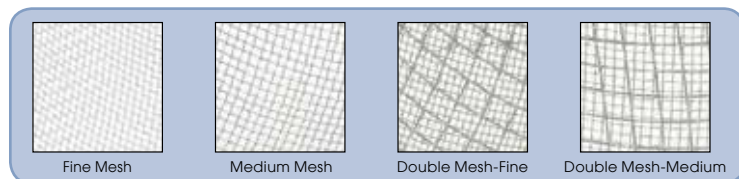

### SINGLE MESH STRAINER

ITEM	DESCRIPTION	DIA	UOM	CASE
MSH-5	Deep Bowl	5-1/2"	Each	12/48

## STAINLESS STEEL MESH STRAINERS



### BREADING BASKETS

The plastic non-stick coating on these steel wired breading baskets ensures that batter/breading sticks to chicken, shrimp or onion rings and not to the basket.

ITEM	DESCRIPTION	DIA	UOM	CASE
MSBW-08	Coarse Mesh	8"	Each	12/36
MSBW-08M	Medium Mesh	8"	Each	12/36
MSBW-10	Coarse Mesh	10"	Each	12/36
MSBW-10M	Medium Mesh	10"	Each	12/36
MSBW-12	Coarse Mesh	12"	Each	12/36
MSBW-12M	Medium Mesh	12"	Each	12/36

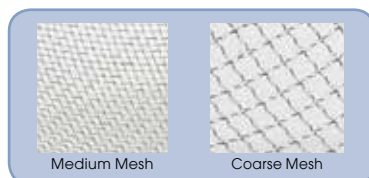

### BREADING BASKETS



FUNNELS



PF-32



SF-6

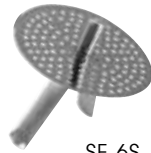

SF-6S

PLASTIC FUNNELS

ITEM	DESCRIPTION	SIZE	UOM	CASE
PF-8	8 Oz	4"Dia	Each	6/324
PF-16	16 Oz	5-1/4"Dia	Each	6/324
PF-32	32 Oz	6-1/4"Dia	Each	6/216

WIDE-MOUTH FUNNELS & REMOVABLE STRAINERS

◆ Stainless steel mirror finish for SF-5 and SF-6

ITEM	DESCRIPTION	UOM	CASE
SF-5	5" Funnel	Each	12/72
SF-6	5-3/4" Funnel	Each	12/72
SF-6S	Strainer for SF-5 and SF-6	Each	120/480

DISPENSERS



OC-24



PBST-1.5



OIL CAN WITH BRASS COVER

ITEM	DESCRIPTION	UOM	CASE
OC-24	24 Oz	Each	1/12



PLASTIC BASTER

◆ 1-1/2 oz capacity with rubber bulb

ITEM	DESCRIPTION	UOM	CASE
PBST-1.5	7-1/2" Tube, 11" O.L.	Each	12/72



PSUD-32



PSUD-48

BPA FREE

BPA FREE

SYRUP DISPENSERS

◆ Stainless steel dispenser slide prevents dripping

◆ Ideal for batter, dressing, juice

◆ BPA-free



ITEM	DESCRIPTION	UOM	CASE
PSUD-32	32 Oz	Each	12
PSUD-48	48 Oz	Each	12
PSUD-WLID	Lid, White	Each	24/144
PSUD-RLID	Lid, Red	Each	24/144
PSUD-TLID	Lid, Tan	Each	24/144



PSUD-RLID



PSUD-TLID

**BUTTER ROLLER**

- ◆ Standard 1/6 size steam table pan, fits into 7"L x 6-3/8"W size opening
- ◆ Reduces butter and dressing waste
- ◆ Roller is removable for easy cleaning
- ◆ Spreads butter quickly and evenly
- ◆ Sturdy stainless steel construction
- ◆ Designed for countertop access
- ◆ Provides safe and sanitary food preparation

ITEM	DESCRIPTION	UOM	CASE
SPBR-604	7"L x 6-3/8"W	Each	1/6

**DISPENSERS**



SPBR-604

**WIDE-MOUTH SQUEEZE BOTTLES**

- ◆ Open tip, no cutting required, easy to refill
- ◆ Each pack contains six (6) pieces
- ◆ BPA-free

ITEM	DESCRIPTION	UOM	CASE
PSW-12	12 Oz, Clear	Pack	1/12
PSW-12R	12 Oz, Red	Pack	1/12
PSW-12Y	12 Oz, Yellow	Pack	1/12
PSW-16	16 Oz, Clear	Pack	1/8
PSW-16R	16 Oz, Red	Pack	1/8
PSW-16Y	16 Oz, Yellow	Pack	1/8
PSW-24	24 Oz, Clear	Pack	1/8
PSW-24R	24 Oz, Red	Pack	1/8
PSW-24Y	24 Oz, Yellow	Pack	1/8
PSW-32	32 Oz, Clear	Pack	1/6
PSW-32R	32 Oz, Red	Pack	1/6
PSW-32Y	32 Oz, Yellow	Pack	1/6



Wide-mouth squeeze bottle



6 per pack



PSW-24

PSW-SERIES **BPA FREE**

**REGULAR SQUEEZE BOTTLES**

- ◆ Open tip, no need for cutting
- ◆ Each pack contains six (6) pieces
- ◆ BPA-free

ITEM	DESCRIPTION	UOM	CASE
PSB-08C	8 Oz, Clear	Pack	1/12
PSB-08R	8 Oz, Red	Pack	1/12
PSB-08Y	8 Oz, Yellow	Pack	1/12
PSB-12C	12 Oz, Clear	Pack	1/12
PSB-12R	12 Oz, Red	Pack	1/12
PSB-12Y	12 Oz, Yellow	Pack	1/12
PSB-24C	24 Oz, Clear	Pack	1/6
PSB-24R	24 Oz, Red	Pack	1/6
PSB-24Y	24 Oz, Yellow	Pack	1/6



PSB-SERIES **BPA FREE**

## SCOOPS



IS-4



SSC-3



AS-85



ASFB-SERIES



**NSF** PS-SERIES  
(5 TO 50 OZ)



PS-64

### STAINLESS STEEL ICE SCOOP

ITEM	DESCRIPTION	UOM	CASE
IS-4	4 Oz Ice Scoop	Each	12/144

### STAINLESS STEEL SCOOPS

ITEM	DESCRIPTION	UOM	CASE
SSC-2	1 Qt (32 Oz) Utility Scoop	Each	6/24
SSC-3	2 Qt (64 Oz) Large Utility Scoop	Each	6/18

### ALUMINUM SCOOPS

◆ Hand wash only

ITEM	DESCRIPTION	UOM	CASE
AS-5	5 Oz	Each	12/60
AS-12	12 Oz	Each	12/60
AS-24	24 Oz	Each	12/60
AS-38	38 Oz	Each	12/48
AS-58	58 Oz	Each	12/36
AS-85	85 Oz	Each	12/24

### ALUMINUM FLAT BOTTOM SCOOPS

◆ Hand wash only

ITEM	DESCRIPTION	UOM	CASE
ASFB-4	4 Oz	Each	12/72
ASFB-7	7 Oz	Each	12/72
ASFB-16	16 Oz	Each	12/72
ASFB-24	24 Oz	Each	12/48

### POLYCARBONATE SCOOPS

◆ NSF listed

ITEM	DESCRIPTION	UOM	CASE
PS-5	5 Oz	Each	24/144
PS-10	10 Oz	Each	24/144
PS-20	20 Oz	Each	24/144
PS-32	32 Oz	Each	12/72
PS-50	50 Oz	Each	12/72

### POLYPROPYLENE SCOOP

ITEM	DESCRIPTION	UOM	CASE
PS-64	64 Oz, White	Each	12/48

## SCOOP HOLDERS



WHW-4



WHW-7



Scoops sold separately

### SCOOP HOLDERS

- ◆ Mount to the wall for ease of reach and sanitation
- ◆ Keeps scoops off food prep surfaces
- ◆ Plastic coated wire

ITEM	DESCRIPTION	SIZE (L X W)	UOM	CASE
WHW-4	Holds AS-12, AS-24, PS-10 & PS-20	4-1/4" x 5-3/8"	Each	12/48
WHW-7	Holds AS-38, AS-58, PS-32 & PS-50	7" x 8"	Each	12/48



**ERGONOMIC KITCHEN TOOLS**

- ◆ Made of stainless steel with a comfortable non-slip soft-grip handle
- ◆ Dishwasher safe
- ◆ NSF listed

ITEM	DESCRIPTION	UOM	CASE
VP-300	Straight Edge "Y" Peeler	Each	12/72
VP-301	Serrated Edge "Y" Peeler	Each	12/72
VP-302	Julienne Peeler	Each	12/72
VP-303	Straight Peeler	Each	12/72
VP-304	Serrated Edge Straight Peeler	Each	12/72
VP-305	Apple Corer	Each	12/72
VP-306	Zester/Lemon Peeler	Each	12/72
VP-307	Melon Baller	Each	12/72
VP-308	Tomato Stem Corer	Each	12/72
VP-309	Cheese Plane	Each	12/72
VP-310	Butter Curler	Each	12/72
VP-314	2-7/8" Oyster/Clam Knife	Each	12/72
VP-315	Small Pizza Cutter 2-1/2" Wheel Blade	Each	12/72
VP-316	Large Pizza Cutter 4" Wheel Blade	Each	12/72
VP-311	Grater w/1.5mm Dia Holes	Each	12/72
VP-312	Grater w/3mm Dia Holes	Each	12/72
VP-313	Grater w/6mm Dia Holes	Each	12/72



**EXTRA STRENGTH  
WIRE FRAME  
RESISTS BENDING**

**ERGONOMIC  
KITCHEN TOOLS**

VP-SERIES **NSF**



## ROTARY CHEESE GRATERS



### STAINLESS STEEL CHEESE GRATER

- ◆ 18/8 stainless steel rotary grater with one drum for grating fine cheeses

ITEM	DESCRIPTION	UOM	CASE
GRTS-1	8-1/4"L x 4-3/4"W x 3-3/8"H	Each	12/36



### PLASTIC CHEESE GRATER

- ◆ Ideal for grating hard cheese or chocolate
- ◆ Includes two (2) interchangeable drums for fine and coarse grating
- ◆ Dishwasher safe

ITEM	DESCRIPTION	UOM	CASE
PRTS-2	7"L x 3-1/2"W x 4-3/8"H	Each	6/24

## GRATERS WITH COVER



GT-103



GT-104



GT-105



GT-106



GT-204



GT-345



### GRATERS WITH COVER

- ◆ Etched 18/8 stainless steel blade, black soft-grip handle
- ◆ Anti-corrosive and durable
- ◆ Anti-slip feet (available on GT-204 and -345)
- ◆ Two blade types in one product (GT-345 only)
- ◆ Dishwasher safe

ITEM	DESCRIPTION	UOM	CASE
GT-103	Medium Coarse Blade	Each	12/72
GT-104	Zester Blade	Each	12/72
GT-105	Fine Blade	Each	12/72
GT-106	Ribbon Blade	Each	12/72
GT-204	Zester Blade & Anti-Slip Feet	Each	12/72
GT-345	Half Zester / Half Fine Blade & Anti-Slip Feet	Each	12/72

		GT-100 series with soft-grip handle and one (1) type of blade per item	GT-204 with additional anti-slip feet and all features of GT-100 series	GT-345 with anti-slip feet and two (2) types of blades on one item	GT-401 box grater with soft-grip handle & five (5) blade sides, including slicer side
MEDIUM COARSE		GT-103			✓
ZESTER		GT-104	✓	✓	✓
FINE		GT-105		✓	✓
RIBBON		GT-106			✓

## BOX GRATERS



SQG-1



GT-401



SQG-4



### ERGONOMIC BOX GRATER

- ◆ Etched 18/8 stainless steel blade, black soft-grip handles

ITEM	DESCRIPTION	UOM	CASE
GT-401	5-Sided Grater: Slicer, Medium Coarse, Zester, Fine, Ribbon	Each	12/48

### STAINLESS STEEL BOX GRATERS

ITEM	DESCRIPTION	SIZE	UOM	CASE
SQG-1	Tapered Grater	4" x 3" x 9"	Each	12/72
SQG-4	Box Grater	4" x 4" x 9"	Each	12/24



### PINEAPPLE CORER

- ◆ Heavy-duty stainless steel cutting shaft
- ◆ Cores and rings pineapple with a simple twist, extracting fruit without eyes or peels attached
- ◆ Includes cap to protect serrated teeth when not in use

ITEM	DESCRIPTION	UOM	CASE
SPC-3	Pineapple Corer	Each	6/24

### CHERRY CORER

- ◆ Quickly and easily remove cherry or olive pits
- ◆ Stainless steel
- ◆ Dishwasher safe

ITEM	DESCRIPTION	UOM	CASE
SCC-5	5-1/4" O.L.	Each	12/144

### ALUMINUM APPLE HAND-PRESS SLICER

- ◆ Wedge and core with a single press

ITEM	DESCRIPTION	UOM	CASE
AAD-12	4-3/8"Dia	Each	12/48

### TOMATO STEM CORERS

ITEM	DESCRIPTION	UOM	CASE
TSC-2	Stainless Steel	Doz	24/144
TSC-2-2R	2-Pcs/Pk, Retail Pkg	Pack	144



### MELON BALLERS

ITEM	DESCRIPTION	UOM	CASE
MB-1	2-Sided, Wooden Hdl	Each	24/240
MB-2P	2-Sided, PP Hdl	Each	24/240

### GRAPEFRUIT SPOON

*Complete any table setting with this grapefruit spoon. The serrated edge cuts easily into any citrus fruit, which also makes it ideal for food prep.*

- ◆ Stainless steel

ITEM	DESCRIPTION	UOM	CASE
SRS-6	6-1/4" O.L.	Doz	1/25

### MANUAL JUICE SQUEEZER

- ◆ Stainless steel

ITEM	DESCRIPTION	UOM	CASE
JC-4	5"Dia	Each	24

### HANDHELD CITRUS SQUEEZERS

*Extract all the juice without the rind, pulp or seeds.*

- ◆ Made from aluminum with baked-on enamel coating
- ◆ Place citrus half with cut side down in juicer and extract
- ◆ Dishwasher safe, long lasting, won't absorb odors, as well as resistant to moisture, heat and stains

ITEM	DESCRIPTION	UOM	CASE
LS-8G	2-1/2"Dia	Each	6/48
LS-9O	3-1/2"Dia	Each	9/36
LS-9Y	3"Dia	Each	6/48

## FRUIT PREP TOOLS



## KITCHEN SHEARS



KS-01



Built-in cracker and bottle cap opener



KS-06



Built-in cracker or bottle cap grip



Built-in bottle cap opener



KS-06 is detachable



#aceofblades



### KITCHEN SHEARS

ITEM	DESCRIPTION	UOM	CASE
KS-01	All purpose	Each	12/120
KS-06*	All purpose, Detachable	Each	12/72

\*Replaces KS-04



### POULTRY SHEARS

ITEM	DESCRIPTION	UOM	CASE
KS-02	Stainless Steel, Soft PP Hdl	Each	12/72
KS-03	Stainless Steel	Each	10/50



KS-02



Locks closed



KS-03



Locks closed



KS-05



Cut, chop, mince herbs



### HERB SHEARS

Easily chop fresh herbs with these shears featuring five (5) durable stainless steel blades.

- ◆ Works well on basil, thyme, mint and more
- ◆ Ideal for cutting, chopping and mincing herbs
- ◆ Comfortable PP and TPR handles for easy grip

ITEM	DESCRIPTION	UOM	CASE
KS-05	5-Layer Blade	Each	12/72

## SPECIALTY UTENSILS



CS-44P



CS-44W



### WIRE CHEESE SLICERS

- ◆ Provides a smoother cut than cheese knives
- ◆ 44" long 18/8 stainless steel wire
- ◆ Customized control over slicing thickness and angle
- ◆ Easy cleanup

ITEM	DESCRIPTION	UOM	CASE
CS-44P	Polyethylene Hdl	Each	24/144
CS-44W	Wooden Hdl	Each	24/144



PLK-11G

BPA FREE



### PLASTIC LETTUCE KNIFE

- ◆ Prevents oxidation so lettuce will not turn brown
- ◆ Serrated edges are also ideal for cutting fruits, and slicing bread and cake
- ◆ Safe to use on non-stick cookware
- ◆ Dishwasher safe
- ◆ BPA-free

ITEM	DESCRIPTION	UOM	CASE
PLK-11G	11-1/2"L	Each	24/144



POA-8



### ALUMINUM PAIL OPENER

- ◆ Open large buckets and pails with ease
- ◆ Built-in hammer assists in closing lids for a tight seal

ITEM	DESCRIPTION	UOM	CASE
POA-8	8-7/16"L x 1-7/16"W x 2-3/4"H	Each	6/72

SPECIALTY UTENSILS



**TWIST & OUT™ CHROME-PLATED CAN OPENERS**

- ◆ Soft-grip handle helps to reduce hand fatigue while providing leverage when turning the crank
- ◆ Smooth cutting blade makes all day prep easier
- ◆ Durable frame handles size 10 cans with ease

ITEM	DESCRIPTION	UOM	CASE
CO-901	7"L, Easy-Turn Handle	Each	12/48
CO-902	8-3/4"L, Crank Handle	Each	12/48



Twist & Out™ hanging packaging



Front gears Back handle



CO-901 CO-902

Front gears Back handle

**ALL-IN-ONE ALUMINUM ALLOY GARLIC PRESS & SLICER**

- ◆ Rust-resistant with a non-stick coating
- ◆ Simplify cleaning with tool attached to inside of handle
- ◆ Easy to store and convenient to use
- ◆ Solid, sturdy, comfortable-to-squeeze handles

ITEM	DESCRIPTION	UOM	CASE
GP-2	Garlic Press, Non-Stick	Each	1/72

**ALUMINUM ALLOY GARLIC PRESS**

ITEM	DESCRIPTION	UOM	CASE
GP-1	Garlic Press	Each	12/96



GP-2 GP-1

**STAINLESS STEEL NUT CRACKER**

ITEM	DESCRIPTION	UOM	CASE
LC-04	4-3/4"	Each	24/144



LC-04

**VEGETABLE PEELERS**

ITEM	DESCRIPTION	UOM	CASE
VP-1	Nickel Plated Handle	Doz	2/24
VP-2	Plastic Handle	Doz	2/24

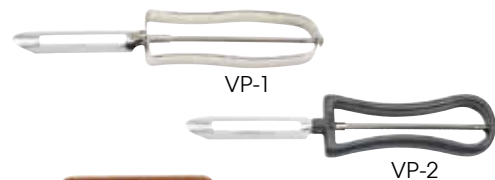

VP-1 VP-2

**STAINLESS STEEL SERRATOR**

ITEM	DESCRIPTION	UOM	CASE
SRT-7	7" w/Wooden Hdl	Each	12/72



SRT-7

**STAINLESS STEEL EGG SEPARATOR**

- ◆ 8-1/2" easy-grip hollow handle
- ◆ Easy to separate an egg white from its yolk
- ◆ Great for preparing crème brûlée, pudding, tiramisu and soufflé
- ◆ Dishwasher safe

ITEM	DESCRIPTION	UOM	CASE
SES-3	2-7/8"Dia	Each	24/96



SES-3

**ALUMINUM EGG SLICERS**

- ◆ Multiple slicing with one press
- ◆ Stainless steel wires are clamped into the casing; no risk of wires slipping out of the pegs

ITEM	DESCRIPTION	UOM	CASE
AES-1	Round	Each	12/144
AES-4	Square	Each	1/96



AES-1 AES-4

## MEAT PREP TOOLS



MT-4

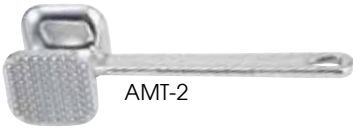

AMT-2



AMT-3



AMT-4



SWS-74



SWS-94

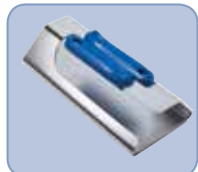

Nested together for additional weight

NEW SIZE



NSF SWS-SERIES



SWA-2



SWA-5



HP-4



PSM-SERIES

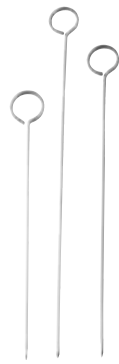

SKO-SERIES



WSK-10

## ALUMINUM MEAT TENDERIZERS

ITEM	DESCRIPTION	HEAD SIZE	O.L.	UOM	CASE
MT-4	2-Sided, Wooden Hdl.	3" x 2-1/2"	13"	Each	12/24
AMT-2	2-Sided	3" x 3"	10-1/2"	Each	1/36
AMT-3	3-Sided	3" x 2-3/8"	11"	Each	1/20
AMT-4	2-Sided, Heavy Alu	4-1/4" x 2-3/4"	12-3/4"	Each	1/12



## ONE-PIECE 18/8 STAINLESS STEEL STEAK WEIGHT WITH SILICONE SLEEVE

- ◆ Unique one-piece design
- ◆ Can be stacked/nested together for heavier weight
- ◆ Handle is heat-resistant up to 450°F (230°C)
- ◆ NSF listed

ITEM	DESCRIPTION	SIZE	UOM	CASE
SWS-74	2 Lb, Red	7-1/2" x 4"	Each	1/12
SWS-94	3 Lb, Blue	9-3/4" x 4-3/4"	Each	1/8

## STEAK WEIGHTS

- ◆ Press meats for even cooking

ITEM	DESCRIPTION	SIZE	UOM	CASE
SWA-1	1 Lb Cast Alu	4-1/4" x 8-1/4"	Each	1/12
SWA-5	1 Lb Cast Alu	5-1/4" x 9"	Each	1/12
SWA-2	2 Lbs Cast Iron	4-1/4" x 8-1/4"	Each	6
SWA-9	2.5 Lbs Cast Iron	5-1/4" x 9"	Each	6

## HAMBURGER PRESS

- ◆ Adjustable patty thickness

ITEM	DESCRIPTION	UOM	CASE
HP-4	4-1/2"Dia	Each	12/36



## STEAK MARKERS

- ◆ Each bag contains 1,000 pieces
- ◆ 2.0mm thickness
- ◆ Labeled for rare, medium rare, medium, medium well and well done

ITEM	DESCRIPTION	COLOR	UOM	CASE
PSM-R	Rare	Red	Bag	1/5
PSM-MR	Medium Rare	Pink	Bag	1/5
PSM-M	Medium	White	Bag	1/5
PSM-MW	Medium-Well	Yellow	Bag	1/5
PSM-W	Well Done	Tan	Bag	1/5



## OVAL STAINLESS STEEL SKEWERS

- ◆ Flat needle keeps food from turning while cooking/grilling

ITEM	DESCRIPTION	UOM	CASE
SKO-8	8"	Doz	5/100
SKO-10	10"	Doz	5/60
SKO-12	12"	Doz	5/60



## BAMBOO SKEWERS

- ◆ Each bag contains 100 pieces

ITEM	DESCRIPTION	UOM	CASE
WSK-06	6"	Bag	30/240
WSK-08	8"	Bag	30/240
WSK-10	10"	Bag	30/120
WSK-12	12"	Bag	30/120

### FISH BONE TWEEZERS

- ◆ Ideal for removing fish pin bones
- ◆ Stainless steel; dishwasher safe

ITEM	DESCRIPTION	UOM	CASE
TTG5-2PK	2-Pcs/Pk	Pack	12/144

### SHRIMP DEVEINER

- ◆ Devein and peel shrimp with one tool
- ◆ Aluminum

ITEM	DESCRIPTION	UOM	CASE
SDA-7	2-Pcs/Pk	Pack	12/144

### SCALE PEELER

- ◆ Stainless steel
- ◆ NSF listed

ITEM	DESCRIPTION	UOM	CASE
FSP-9	9-1/2"L	Each	60/240

### LOBSTER CRACKERS

ITEM	DESCRIPTION	SIZE	UOM	CASE
LC-01	Stainless Steel	6"	Each	12/72
LC-03	Chrome Plated, Large	6"	Each	12/144
LC-04	Nut / Lobster Cracker	4-3/4"	Each	24/144
LC-05	Zinc Alloy	6"	Each	12/72
LC-85	Zinc Alloy, Carded	6"	Each	12/72

### SEAFOOD PICKS

- ◆ 18/8 stainless steel with decorative lobster stamp
- ◆ Narrow two-tine fork designed to effortlessly reach more shellfish meat
- ◆ Each pack contains four (4) pieces

ITEM	DESCRIPTION	UOM	CASE
LC-08	8"L x 3/4"W	Pack	30/120

## SEAFOOD PREPARATION



2PCS PER PACK



LC-85



SDA-7



FSP-9 NSF



LC-01



LC-03



LC-08



LC-04



LC-05

### OYSTER/CLAM KNIVES

ITEM	DESCRIPTION	SIZE	UOM	CASE
VP-314	2-7/8" Blade, Soft Rubber Grip NSF	7-5/8" O.L.	Each	12/72
KCL-5P	3" Blade, Plastic Handle, NSF	6-3/4" O.L.	Each	12/72
KCL-1	2-3/4" Blade, Wooden Handle	5-7/8" O.L.	Each	12/72
KCL-2	2-7/8" Blade, Wooden Handle	6-5/8" O.L.	Each	12/72
KCL-3	3-1/2" Blade, Wooden Handle	7-1/2" O.L.	Each	12/72



KCL-3



KCL-2



VP-314 NSF



KCL-5P NSF



KCL-1

### OYSTER/CLAM KNIVES

### STAINLESS STEEL PROTECTIVE MESH GLOVES

Made for meat processing, the rust-resistant 304L stainless steel rings that form these mesh gloves protect hands from cuts and punctures while deboning and butchering. Each glove is reversible and is fixed with a wrist strap that features a snap and cinch fastener to keep it secure.

- ◆ Lightweight and non-corrosive
- ◆ Wrist length

ITEM	DESCRIPTION	SIZE	UOM	CASE
PMG-1S	White Strap	Small	Each	10/50
PMG-1M	Red Strap	Medium	Each	10/50
PMG-1L	Blue Strap	Large	Each	50

### PROTECTIVE GLOVES



Closure Detail



Mesh Detail



PMG-1L

GRILL TOOLS

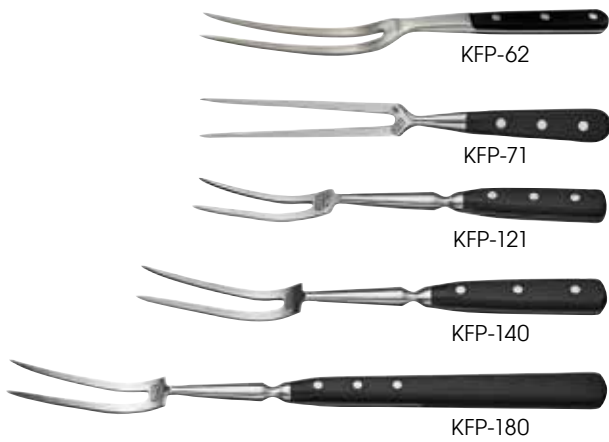

ACERO FORGED COOK'S FORKS

◆ Extra heavyweight with POM handle

ITEM	DESCRIPTION	PRONGS	UOM	CASE
KFP-62	Curved, 12" w/Hdl	6"L	Each	6/36
KFP-71	Straight, 12" w/Hdl	6"L	Each	6/36
KFP-121	Curved, 12" w/Hdl	4"L	Each	6/36
KFP-140	Curved, 14" w/Hdl	5"L	Each	6/36
KFP-180	Curved, 18" w/Hdl	5"L	Each	6/36

NSF KFP-SERIES



KPF-612



KPF-210

POT FORKS

ITEM	DESCRIPTION	UOM	CASE
KPF-612	12-5/8" O.L.	Each	12/120
KPF-210	21-7/8" O.L.	Each	12/72



PANCAKE TURNER

◆ Heat resistant up to 608°F (320°C)  
◆ Nylon blade with 18/8 stainless steel handle



STN-3



STN-6

STN-8

ITEM	DESCRIPTION	UOM	CASE
STN-3	15-7/16" O.L.	Each	24/48

STAINLESS STEEL SERVING TURNERS

ITEM	DESCRIPTION	UOM	CASE
STN-6	14" O.L., Solid	Each	12/120
STN-8	14" O.L., Slotted	Each	12/120



APP-20

ALUMINUM PIZZA/BURGER PEEL

◆ 14 gauge, 1.6mm thick  
◆ 11" handle, 20" overall length

ITEM	DESCRIPTION	UOM	CASE
APP-20	9"L x 6-3/4"W Blade	Each	12/48

### STAINLESS STEEL EGG RINGS

- ◆ Achieve consistent results
- ◆ 1" high round or square ring with angled handle

ITEM	DESCRIPTION	UOM	CASE
EGR-3	3" Dia	Each	12/144
EGR-4	4" Dia	Each	12/144
EGR-5	5" Dia	Each	12/144
EGR-6	6" Dia	Each	12/96
EGRS-44	4" x 4"	Each	12/144

### GRILL TOOLS



EGR-6

EGRS-44

### ALUMINUM GRILL BASTING COVERS

- ◆ Contain mess and splatter from frying food on the grill
- ◆ Cover entrée to keep it warm until ready to serve
- ◆ Bakelite knob handle

ITEM	DESCRIPTION	UOM	CASE
ADBC-7	7"Dia	Each	6/12
ADBC-8	8"Dia	Each	6/12
ADBC-9	9"Dia	Each	6/12
ADBC-10	10"Dia	Each	6/12



ADBC-7

### ALUMINUM DOME GRILL BASTING COVER

- ◆ Used to cover hamburgers and hold in steam for thorough, even cooking

ITEM	DESCRIPTION	UOM	CASE
AHC-6	6"Dia	Each	12/48



AHC-6

### WINCO® PRIME STAINLESS STEEL FRENCH FRY BAGGERS

- ◆ Removable handles for easy cleaning
- ◆ NSF listed

ITEM	DESCRIPTION	UOM	CASE
FFBN-1R	Right Handle, NSF	Each	12/36
FFBN-2	Dual Handles, NSF	Each	12/36



### FRYER ACCESSORIES



FFBN-2



FFBN-1R

FFBN-SERIES NSF

### FRENCH FRY BAGGERS

ITEM	DESCRIPTION	UOM	CASE
FFB-1R	Right Handle	Each	12/36
FFB-2	Dual Handles	Each	12/36



FFB-2



FFB-1R

### FRYER FILTER STAND & FILTERS

- ◆ Cloth filters are heat resistant up to 392°F (200°C)

ITEM	DESCRIPTION	UOM	CASE
FF-10	10" Fryer Filter Stand	Each	20
FF-RC	Rayon Cloth Filter Cones (10-Pcs/Box)	Box	1/60



FF-10 & FF-RC

### FRYER SCREEN

- ◆ For use with: Imperial: IFS-40; DCS: FRFG-40; American Range: AF-45; PITCO: 35C and 45C
- ◆ Chrome-plated

ITEM	DESCRIPTION	UOM	CASE
FS-1313	13" x 13"	Each	12/48

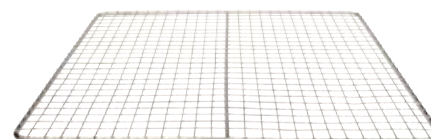

FS-1313

# BACK OF HOUSE

## *Clean & Organize*





**CARPET ENTRYWAY FLOOR MATS**

- ◆ Vinyl backing prevents curling/ripping and stays flat
- ◆ Carts roll easily over the tapered rubber edge

ITEM	DESCRIPTION	COLOR	UOM	CASE
FMC-310C	3' x 10'	Charcoal	Each	1
FMC-310U	3' x 10'	Burgundy	Each	1
FMC-35C	3' x 5'	Charcoal	Each	1
FMC-35U	3' x 5'	Burgundy	Each	1
FMC-46C	4' x 6'	Charcoal	Each	1
FMC-46U	4' x 6'	Burgundy	Each	1

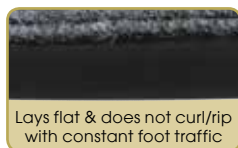

**ENTRYWAY FLOOR MATS**

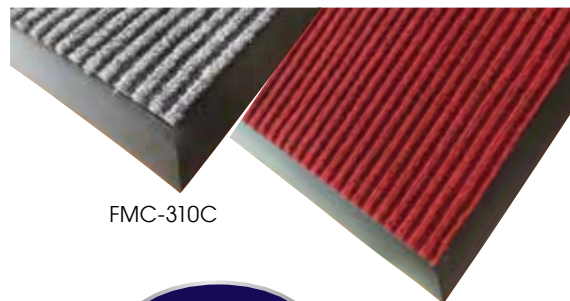

FMC-310C

FMC-310U

TAPERED, WEIGHTED, DURABLE

**ANTI-FATIGUE RUBBERIZED GEL FOAM FLOOR MAT**

- ◆ Ideal for standing-in-place jobs
- ◆ Beveled edges reduce tripping
- ◆ Comfortable and supportive closed-cell foam
- ◆ Grease-resistant and waterproof
- ◆ 1/2" thick

ITEM	DESCRIPTION	COLOR	UOM	CASE
FMG-23K	2' x 3'	Black	Each	24



1/2" THICK

**ANTI-SLIP & ANTI-FATIGUE FLOOR MATS**



**STRAIGHT EDGE NATURAL RUBBER FLOOR MATS**

- ◆ Anti-slip & anti-fatigue top-grade natural rubber
- ◆ Excellent drainage in wet areas
- ◆ All straight-edge mats are grease-resistant - use in grease-prone areas to prevent slipping
- ◆ Trim to customize size for best fit
- ◆ 3/4" thick

ITEM	DESCRIPTION	COLOR	UOM	CASE
RBMH-35K	3' x 5'	Black	Each	1
RBMH-35R	3' x 5'	Red	Each	1
RBMH-35K-R	3' x 5', Rolled	Black	Each	1
RBMH-35R-R	3' x 5', Rolled	Red	Each	1

3/4" THICK  
GREASE-RESISTANT

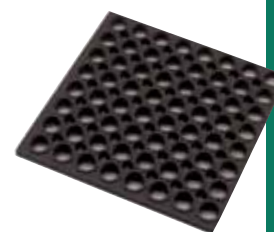
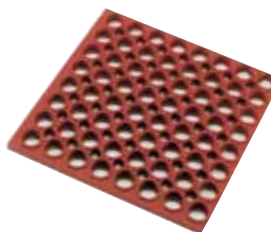

**BEVELED EDGE FLOOR MATS**

- ◆ Anti-slip & anti-fatigue top-grade natural rubber
- ◆ Tapered edges help reduce tripping
- ◆ RED beveled edge mats are grease-resistant - use in grease-prone areas to prevent slipping
- ◆ 1/2" thick

ITEM	DESCRIPTION	COLOR	UOM	CASE
RBM-35K	3' x 5'	Black	Each	1
RBM-35R	3' x 5', Grease-Resist	Red	Each	1
RBM-35K-R	3' x 5', Rolled	Black	Each	1
RBM-35R-R	3' x 5', Rolled, Grease-Resist	Red	Each	1

RED BEVELED EDGE MATS ARE GREASE-RESISTANT

AVAILABLE FLAT OR ROLLED

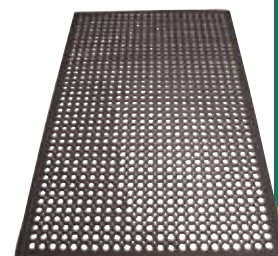
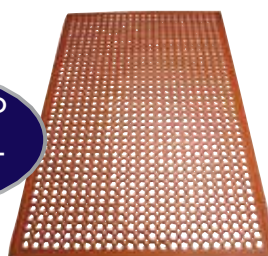

**INTERLOCKING FLOOR MATS**

- ◆ Molded-in connectors for self-locking system
- ◆ Create custom shapes/sizes to fit various applications
- ◆ RED interlocking mat is grease-resistant - use in grease-prone areas to prevent slipping
- ◆ Anti-slip & anti-fatigue
- ◆ 1/2" thick

ITEM	DESCRIPTION	COLOR	UOM	CASE
RBMI-33K	3' x 3'	Black	Each	1
RBMI-33R	3' x 3', Grease-Resist	Red	Each	1

1/2" THICK

RED INTERLOCKING MAT IS GREASE-RESISTANT

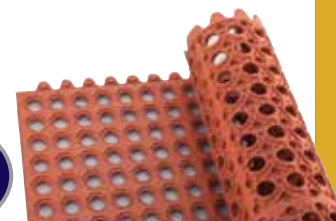

## WASTE BASKETS



**NEW** PWR-28L    **NEW** PWR-28K    **NEW** PWR-41BE

## WASTE BASKETS

These anti-jamming plastic cans feature a rolled edge for added strength and easy grip.

- ◆ 28 or 41 quart capacity options

ITEM	DESCRIPTION	COLOR	UOM	CASE
PWR-28BE	28 Qt	Beige	Each	1/12
PWR-28K	28 Qt	Black	Each	1/12
PWR-28L	28 Qt, RECYCLE	Blue	Each	1/12
PWR-41BE	41 Qt	Beige	Each	1/12
PWR-41K	41 Qt	Black	Each	1/12

## SLENDER TRASH CANS & LIDS



**NEW**

PTC-23GRC & PTCL-23GR

PTC-23SG & PTCL-23

## SLENDER TRASH CANS

- ◆ Compact size is great for use in locations where space is limited
- ◆ Rolled top-rim for added strength
- ◆ Rounded edges and corners for easier cleaning
- ◆ Made of durable, high-density polypropylene making it resistant to moisture and certain cleaning solutions
- ◆ Lids sold separately

ITEM	DESCRIPTION	COLOR	UOM	CASE
PTC-23GRC	23 Gallon, Compost	Green	Each	1
PTC-23L	23 Gallon, Recycle	Blue	Each	1
PTC-23K	23 Gallon	Black	Each	1
PTC-23SG	23 Gallon	Gray	Each	1
PTC-23B	23 Gallon	Brown	Each	1

## LIDS FOR SLENDER TRASH CANS

- ◆ Counterbalanced swing lids

ITEM	DESCRIPTION	COLOR	UOM	CASE
PTCL-23GR	Lid for PTC-23GRC	Green	Each	4
PTCL-23L	Lid for PTC-23L	Blue	Each	4
PTCL-23K	Lid for PTC-23K	Black	Each	4
PTCL-23	Lid for PTC-23SG	Gray	Each	4
PTCL-23B	Lid for PTC-23B	Brown	Each	4



PTCL-23L

PTCL-23K

PTCL-23B

## SPECIALTY LIDS

ITEM	DESCRIPTION	COLOR	UOM	CASE
PTCB-23L	Bottle/Can Recycling Cover for PTC-23L	Blue	Each	1/6
PTCP-23L	Paper Recycling Cover for PTC-23L	Blue	Each	1/6



PTC-23L

PTC-23K

PTC-23B



PTCB-23L

PTCP-23L

## CART FOR SLENDER TRASH CANS



DWR-1708



Fits most standard slim trash cans

## CART FOR SLENDER TRASH CANS

Give slender trash cans mobility to move from one location to another with the ease of this rolling cart built for the task.

- ◆ 400 Lbs capacity with 3-3/4" non-marking casters
- ◆ Zinc-plated to resist rust and corrosion
- ◆ Compatible with PTC-Series 23 gallon slender trash cans

ITEM	DESCRIPTION	UOM	CASE
DWR-1708	18-1/2"L x 9-1/2"W x 12"H	Each	4

Shown with PTC-23SG

### HEAVY-DUTY TRASH CANS

◆ Lid sold separately

ITEM	DESCRIPTION	COLOR	UOM	CASE
PTC-32G	32 Gallon	Gray	Each	1
PTC-44G	44 Gallon	Gray	Each	1
FCW-10	10 Gallon, NSF	White	Each	1/6
FCW-20*	20 Gallon, NSF	White	Each	1/6
FCW-32*	32 Gallon, NSF	White	Each	1/6

\*Works with DLR-series dollies

### HEAVY-DUTY TRASH CANS



PTC-32G & PTCL-32



Locking threads underneath can

### HEAVY-DUTY TRASH CAN LIDS

ITEM	DESCRIPTION	COLOR	UOM	CASE
PTCL-32	Lid for PTC-32G	Gray	Each	6
PTCL-44	Lid for PTC-44G	Gray	Each	6
FCW-10L	Lid for FCW-10, NSF	White	Each	1/24
FCW-20L	Lid for FCW-20, NSF	White	Each	1/12
FCW-32L	Lid for FCW-32, NSF	White	Each	1/12
FCW-10RC	Rotating Lid for FCW-10, NSF	White	Each	1/6
FCW-20RC	Rotating Lid for FCW-20, NSF	White	Each	1/6
FCW-32RC	Rotating Lid for FCW-32, NSF	White	Each	1/6



FCW-32 & FCW-32L

WHITE CANS: FOOD STORAGE CAPACITIES				
ITEM #	CAPACITY (GALLONS)	CAPACITY (CUPS)	FLOUR (LBS)	SUGAR (LBS)
FCW-10	10	150	47	65
FCW-20	20	300	94	130
FCW-32	32	500	156	217



FCW-32RC



Large easy-grip handles

**FCW-SERIES ALSO SAFE FOR FOOD STORAGE**

FCW-SERIES **NSF**  
CONTAINERS & SOLID LIDS **BPA FREE**

### EXTRA HEAVY-DUTY DOLLY

◆ Holds up to 900 lbs

ITEM	DESCRIPTION	UOM	CASE
DLR-2	Extra-Heavy Dolly	Each	2
DLR-2-C	Caster for DLR-2	Each	1

DOLLIES FIT MOST ROUND COMMERCIAL TRASH CANS



Locking threads

**TWIST-ON FOR SECURE FIT**



DLR-2

### DOLLY

◆ Holds up to 400 lbs

ITEM	DESCRIPTION	UOM	CASE
DLR-18	18"Dia x 6"H, Black	Each	2
DLR-18-W	Caster for DLR-18	Each	1



DLR-18

## JANITORIAL CADDY



PJC-1511K

### JANITORIAL CADDY

- ◆ Three deep compartments
- ◆ 15-1/4"W x 10-3/4"D x 6-3/4"H
- ◆ Convenient carry handle

ITEM	DESCRIPTION	UOM	CASE
PJC-1511K	Janitorial Caddy	Each	1/12

## CONTAINER CADDY BAG



JCB-2920

### CONTAINER CADDY BAG

- ◆ Water-resistant material
- ◆ 29"L x 20"H with adjustable straps
- ◆ Multiple pockets fit a variety of cleaning supplies

ITEM	DESCRIPTION	UOM	CASE
JCB-2920	Fits 32 and 44 Gallon Cans	Each	2



Multiple pockets fit a variety of cleaning supplies

## CONTAINER CADDY FOR 44 GALLON CONTAINER



TCD-44Y

### CONTAINER CADDY FOR 44 GALLON CONTAINER

- ◆ Convenient, durable caddy keeps supplies handy for a variety of cleaning tasks
- ◆ Holds two bags open at once for dual disposal option

ITEM	DESCRIPTION	UOM	CASE
TCD-44Y	Fits 44 Gallon PTC-44G	Each	2



Many compartments of varying sizes hold supplies

### ROUND TRASH CAN & LID

- ◆ Trash can and lid sold separately

ITEM	DESCRIPTION	COLOR	UOM	CASE
PTCR-22G	22 Gallon	Gray	Each	1
PTCRL-22G	Lid	Gray	Each	1



Lid and can sold separately



Top view of lid



PTCRL-22G



PTCR-22G

PTCR-22G & PTCRL-22G

AVAILABLE IN JULY 2020

### SQUARE TRASH CANS AND LIDS

- ◆ Large 23 or 35 gallon sizes ideal for high-traffic areas
- ◆ Soft-close gravity lids, no springs
- ◆ Trash cans and lids sold separately

ITEM	DESCRIPTION	COLOR	UOM	CASE
PTCS-23BE	23 Gallon	Beige	Each	1
PTCS-23G	23 Gallon	Gray	Each	1
PTCS-23L	23 Gallon, RECYCLE	Blue	Each	1
PTCS-35BE	35 Gallon	Beige	Each	1
PTCS-35G	35 Gallon	Gray	Each	1
PTCSL-23BE	Lid for PTCS-23BE	Beige	Each	10
PTCSL-23G	Lid for PTCS-23G	Gray	Each	10
PTCSB-23L	Bottle/Can Lid for PTCS-23L	Blue	Each	24
PTCSP-23L	Paper Lid for PTCS-23L	Blue	Each	24
PTCSL-35BE	Lid for PTCS-35BE	Beige	Each	6
PTCSL-35G	Lid for PTCS-35G	Gray	Each	6

### SQUARE CANS & LIDS



PTCS-23L & PTCSP-23L



PTCSB-23L



PTCS-35G & PTCSL-35G



PTCS-35BE

### WASTE RECEPTACLE

- ◆ For indoor use
- ◆ Features tray-top design with 9"H self-return door
- ◆ Fits up to 35 gallon capacity trash can
- ◆ Inside dimensions: 22-7/16"L x 22-7/16"W x 41-11/32"H
- ◆ Ships knocked down
- ◆ Light natural-wood color

ITEM	DESCRIPTION	UOM	CASE
WR-35	23-1/2"L x 23-3/4"W x 44"H	Each	1

### WASTE RECEPTACLE



Self-return swing door



Use PTCS-35G as liner in WR-35



WR-35

MOP BUCKETS

NEW COLOR

SIDE-PRESS WRINGERS AND BUCKETS AVAILABLE AS A SET OR SEPARATELY



MPB-36R

MOP BUCKETS WITH SIDE-PRESS WRINGER

- ◆ 36 Qt capacity bucket
- ◆ Easily lift and empty by grasping the molded handle at rear, and the bail handle on front of bucket
- ◆ Convenient tool slot on rim of bucket accommodates 2-inch wide putty knife
- ◆ Base of bucket slopes downward toward wringer, keeping dirt particles away from mop
- ◆ Side-press wringer features rubber grip and heavy-duty spring action to effectively wring mops
- ◆ Swivel casters with 3" wheels maneuver over thresholds or onto elevators; the bumpers protect walls

RED MOP BUCKET WITH SIDE PRESS WRINGER

ITEM	DESCRIPTION	COLOR	UOM	CASE
MPB-36R	36Qt Bucket & Wringer Combo	Red	Each	1
MPB-36BR	36Qt Bucket	Red	Each	1
MPB-36WR	Side-Press Wringer	Red	Each	2
MPB-36WH	Caster Wheel for MPB-Series		Each	4

YELLOW MOP BUCKET WITH SIDE PRESS WRINGER

ITEM	DESCRIPTION	COLOR	UOM	CASE
MPB-36	36Qt Bucket & Wringer Combo	Yellow	Each	1
MPB-36B	36Qt Bucket	Yellow	Each	1
MPB-36W	Side-Press Wringer	Yellow	Each	2
MPB-36WH	Caster Wheel for MPB-Series		Each	4



MPB-36



Powder-coated wringer handle with rubber grip



Easy-access slot on bucket fits 2" wide putty knife



Non-marking casters with bumpers

FLOOR "CAUTION" SIGNS

FLOOR "CAUTION" SIGNS

ITEM	DESCRIPTION	UOM	CASE
WCS-27T	27"H Cone, "Caution Wet Floor"	Each	5
WCS-25	25" x 12" Sign, English/Spanish "Caution Wet Floor"	Each	12
CSF-4	19-3/4"H Pop-Up Cone, Trilingual "Caution"	Each	12/48
CSF-SET	Pop-Up "Caution" Cone & Wall-Mount Holder Set	Set	6/36



WCS-27T



WCS-25



CSF-4

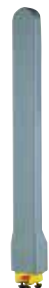

CSF-SET



Set includes pop-up "Caution" cone

### SUPERIOR MICROFIBER LOOP-END WET MOPS

- ◆ Extremely absorbent microfiber mop heads for quick, efficient cleaning
- ◆ Loop-end; tail band fans out strands for more coverage
- ◆ Machine washable

ITEM	DESCRIPTION	UOM	CASE
MOPM-M	Medium	Each	12
MOPM-L	Large	Each	12



Looped ends prevent unraveling



MOPM-M shown with MOPH-7P handle and MPB-36 mop bucket



MOPM-M

### PREMIUM COTTON-POLY BLEND LOOP-END WET MOPS

- ◆ Absorbent cotton-poly blend mop heads
- ◆ Loop-end 4-ply yarn; tail band fans out strands for more mopping coverage
- ◆ 1-1/4" wide headband
- ◆ Machine washable

ITEM	DESCRIPTION	SIZE	UOM	CASE
MOP-24	Blue Tailband	24oz/680g	Each	20
MOP-32	Blue Tailband	32oz/900g	Each	20
MOP-24W	White Tailband	24oz/680g	Each	20
MOP-32W	White Tailband	32oz/900g	Each	20



Looped ends prevent unraveling

Headband



MOP-32W



NEW

Brick pack is standard

Tail band

### ECONOMY COTTON-POLY BLEND CUT-END WET MOPS

- ◆ Absorbent cotton-poly blend mop heads
- ◆ Cut end 4-ply yarn
- ◆ 1-1/4" wide headband

ITEM	DESCRIPTION	SIZE	UOM	CASE
MOP-24C	Blue	24oz/680g	Each	20
MOP-32C	Blue	32oz/900g	Each	20
MOP-24WC	White	24oz/680g	Each	20
MOP-32WC	White	32oz/900g	Each	20



NEW

Brick pack is standard

Headband



MOP-24C

### DISPENSER FOR BRICK PACKS

- ◆ Holds seven (7) brick packs
- ◆ Mount to wall in janitorial supplies closet for convenient and compact storage

ITEM	DESCRIPTION	UOM	CASE
MOPR-22	8" x 6-5/8" x 22"	Each	6

### MOP HANDLES

ITEM	DESCRIPTION	SIZE	UOM	CASE
MOPH-7M	Metal, Quick-Change Screw	57"L	Each	6
MOPH-7P	Plastic, Side-Release Dial	57"L	Each	6

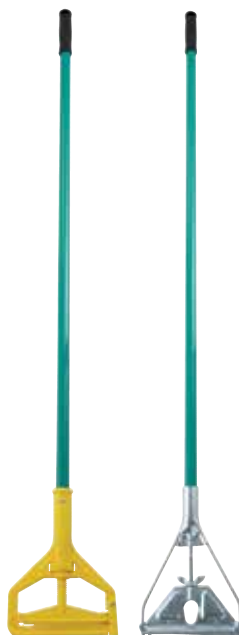

MOPH-7P MOPH-7M



Dispenser holds 7 brick packs



MOPR-22

## DUST MOP HEADS, FRAMES & HANDLES

**NEW**

DMM-24H



**NEW**

DMM-36H



**NEW**

DMB-24H



**NEW**

DMB-36H

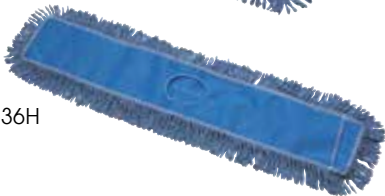

REPLACEMENT HEADS, WIRED FRAME, & HANDLE AVAILABLE AS A SET OR SEPARATELY

DM-60HD

**NEW SIZE**



DM-24

MACHINE WASHABLE

DM-24H

**NEW**

DM-24FM



**NEW**

DM-36FM



### SUPERIOR DUST MOP HEADS

- ◆ Microfiber blend effectively traps dust and lint
- ◆ Fits standard size frames
- ◆ Looped-end; Launderable

ITEM	DESCRIPTION	COLOR	UOM	CASE
DMM-24H	24"	Green	Each	24
DMM-36H	36"	Green	Each	24

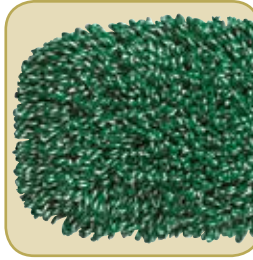

Looped-ends prevent unraveling



Brick pack is standard

**NEW**



### PREMIUM DUST MOP HEADS

- ◆ Cotton blend collects and traps dirt and dust
- ◆ Fits standard size frames
- ◆ Looped-end; Launderable

ITEM	DESCRIPTION	COLOR	UOM	CASE
DMB-24H	24"	Blue	Each	24
DMB-36H	36"	Blue	Each	24



Looped-ends prevent unraveling



Brick pack is standard

**NEW**

### QUALITY DUST MOPS

- ◆ Features nylon backing & convenient zippered closure for easy on-and-off
- ◆ 100% cotton
- ◆ Looped-end center; Launderable

ITEM	DESCRIPTION	COLOR	UOM	CASE
DM-24H	24"	White	Each	1/24
DM-36H	36"	White	Each	24

### DUST MOP SETS: MOP HEADS W/FRAME & HANDLE

- ◆ Sets include frame, mop head and 60"L handle
- ◆ Mop heads are launderable

ITEM	DESCRIPTION	COLOR	UOM	CASE
DM-24	24" Mop, Frame, 60"L Handle	White	Set	1/6
DM-36	36" Mop, Frame, 60"L Handle	White	Set	1/6

### DUST MOP FRAMES & HANDLE

- ◆ Wire frames compatible with 24" or 36" mop heads
- ◆ 60" long lightweight aluminum handle

ITEM	DESCRIPTION	UOM	CASE
DM-24FM	Wire Frame, 24"	Each	24
DM-36FM	Wire Frame, 36"	Each	24
DM-60HD	Aluminum Handle, 60"L	Each	12



**PREMIUM BROOMS**

- ◆ Two-position handle options - upright or angled
- ◆ Long-wear angled bristles to clean hard to reach places
- ◆ Excellent for sweeping dust and debris

**HEAVY-DUTY UNFLAGGED ANGLED BROOMS**

ITEM	DESCRIPTION	COLOR	UOM	CASE
BRAU-9K	Unflagged	Black	Each	12
BRAU-9K-H	Unflagged Broom w/48"L Fiberglass Handle	Black	Set	12

**MEDIUM-DUTY FLAGGED ANGLED BROOMS**

ITEM	DESCRIPTION	COLOR	UOM	CASE
BRAF-9R	Flagged	Red	Each	12
BRAF-9R-H	Flagged Broom w/48"L Fiberglass Handle	Red	Set	12

**MEDIUM-DUTY FLAGGED LOBBY BROOM W/30"L HANDLE**

ITEM	DESCRIPTION	COLOR	UOM	CASE
BRF-6K-H	Flagged, 30"L Hd	Black	Set	12/24

**ECONOMY FLAGGED ANGLED BROOM W/55"L HANDLE**

ITEM	DESCRIPTION	COLOR	UOM	CASE
BRM-60L	Flagged, 55"L Hd	Black	Each	12

**PREMIUM PUSH BROOMS**

- ◆ Structural foam head for superior durability and lightweight
- ◆ Resistant to the elements; will not rust or rot

**PUSH BROOMS - FINE, MEDIUM-DUTY**

- ◆ Fine bristles sweep up small particles and debris
- ◆ Ideal for general indoor use like wood, concrete, and tile

ITEM	DESCRIPTION	COLOR	UOM	CASE
BRFF-18K	18"L	Black	Each	1/12
BRFF-24K	24"L	Black	Each	1/12

**PUSH BROOMS - COARSE, HEAVY-DUTY**

- ◆ Coarse bristles picks up heavy debris and large particles
- ◆ Ideal for outdoor use on rough surfaces such as warehouses, receiving areas and sidewalks

ITEM	DESCRIPTION	COLOR	UOM	CASE
BRFC-18B	18"L	Brown	Each	1/12
BRFC-24B	24"L	Brown	Each	1/12

**BROOM HANDLES - FIBERGLASS W/TEXTURED GRIP**

- ◆ Durable fiberglass construction with textured surface to provide soft comfortable grip
- ◆ Thread onto broom head for secure fit
- ◆ 1" diameter

ITEM	DESCRIPTION	UOM	CASE
BRH-48K	48"L for Angled Brooms	Each	12
BRH-60K	60"L for Push Brooms	Each	12

**FLOOR BROOMS, BRUSHES & HANDLES**



**DECK BRUSH: 10"W MULTI-ANGLE FLOOR SCRUB BRUSH**

- ◆ 0.6mm synthetic bristles

ITEM	DESCRIPTION	UOM	CASE
BRF-10R	10"W	Each	1/12

**12"W MULTI-ANGLE FLOOR SCRUB BRUSH**

- ◆ Great for cleaning those hard-to-reach areas; angled side bristles are ideal for baseboards, under counters and around corners
- ◆ 0.6mm synthetic crimped bristles

ITEM	DESCRIPTION	UOM	CASE
BRF-12Y	12"W	Each	12



## FLOOR SWEEPER & DUST PANS



FSW-11



DP-13C



DP-14R

### ROTARY SWEEPER

- ◆ Manual, quiet non-electric rotary sweeper with natural bristles and steel handle

ITEM	DESCRIPTION	UOM	CASE
FSW-11	11"L x 7-3/4"W x 43"H	Each	1/4

### DUST PANS

ITEM	DESCRIPTION	UOM	CASE
DP-13C	Lobby Dust Pan with Cover, Black, 13"W	Set	1/10
DP-14R	Jumbo Upright Dust Pan, Red, 13-5/8" x 14" x 8-7/8"	Set	12
DP-1618K	Large Floor Dust Pan, Black, 16" x 18" x 5-1/4"	Each	12



Jumbo upright dust pan



DP-1618K

## SQUEEGEES



WSS-12

WS-15

FSS-24

### SQUEEGEES

ITEM	DESCRIPTION	UOM	CASE
WSS-12	12" with 23" Handle	Each	6/24
WS-15	15" Window Squeegee with Telescopic Handle - Aluminum handle extends from 30" to 55"	Each	20
FSS-24	24", Straight Squeegee - Handle sold separately	Each	6
FSC-60H	55" Tapered Wooden Handle for FSS-24	Each	6

FSC-60H

## FLOOR DRAIN STRAINER



FDS-1010

### STAINLESS STEEL FLOOR DRAIN STRAINER

Keeping floors clean is even easier with this floor drain. Perforations catch debris while allowing excess water to pass through.

- ◆ 3/4" wide top rim allows drain to sit against floor surface
- ◆ 8-5/8" interior area; 10" wide overall; 2-5/8" high

ITEM	DESCRIPTION	UOM	CASE
FDS-1010	10"L x 10"W x 2-5/8"H	Each	12

## MOP & BROOM RACKS



MHH-36



MHH-5



### MOP & BROOM RACKS

Maximize space with these mop/broom racks that offer versatile hanging options. Outfitted with non-slip bristles, hooks and clips, they keep kitchen cleaning tools organized and within easy reach.

- ◆ MHH-36 & MHH-24 constructed of aluminum with non-slip rubber bristles that hold tools securely in place
- ◆ MHH-5 constructed of durable ABS plastic with five (5) clips and six (6) hooks

ITEM	DESCRIPTION	UOM	CASE
MHH-5	16"L, 5 Clips and 6 Hooks	Each	1/12
MHH-24	24"L Mop Rack, Rubber Bristles	Each	6/24
MHH-36	36"L Mop Rack, Rubber Bristles	Each	6/12



### HEAVY-DUTY NATURAL LATEX GLOVES

- ◆ Soft, comfortable and durable
- ◆ Made especially for dish washers, launderers, car washers and gardeners

ITEM	DESCRIPTION	UOM	CASE
NLGH-18	10-1/2" x 18-1/2"	Pair	12/24

### NATURAL LATEX GLOVES

ITEM	DESCRIPTION	UOM	CASE
NLG-816	Small, Yellow	Pair	12/60
NLG-916	Medium, Yellow	Pair	12/60
NLG-1018	Large, Black	Pair	12/60

## GLOVES & APRONS



### DISPOSABLE NITRILE GLOVES

- ◆ Stronger, long-lasting glove with excellent dexterity
- ◆ Chemical resistant for multiple uses
- ◆ Powder-free and FDA Compliant
- ◆ 100 pcs/box

ITEM	DESCRIPTION	UOM	CASE
GLN-SB	Small	Box	1/10
GLN-MB	Medium	Box	1/10
GLN-LB	Large	Box	1/10
GLN-XLB	X-Large	Box	1/10



### DISPOSABLE VINYL GLOVES

- ◆ Excellent flexibility without compromising quality
- ◆ Powder-free and FDA Compliant
- ◆ 100 pcs/box

ITEM	DESCRIPTION	UOM	CASE
GLV-SC	Small	Box	1/10
GLV-MC	Medium	Box	1/10
GLV-LC	Large	Box	1/10
GLV-XLC	X-Large	Box	1/10



### DISPOSABLE MULTI-PURPOSE POLY GLOVES

- ◆ Easy on and off
- ◆ Powder-free and latex-free
- ◆ 500 pcs/box

ITEM	DESCRIPTION	UOM	CASE
GLP-M	Medium	Box	1/10
GLP-L	Large	Box	1/10



### WIPES CANISTER BRACKET

- ◆ 4-5/8" diameter

ITEM	DESCRIPTION	UOM	CASE
WHW-5	4" x 5" x 8-1/4"	Each	12/24

### GLOVE BOX HOLDER

ITEM	DESCRIPTION	UOM	CASE
WHW-10	10-1/4" x 3-1/4" x 4-5/8", Fits 9-3/4" x 2-7/8" Box	Each	12/24
WHW-11	10-1/4" x 3-5/8" x 5", Fits 9-3/4" x 3-1/4" Box	Each	12/24

## WALL BRACKETS



WHW-10  
(Gloves not included)



WHW-11  
(Gloves not included)



WHW-5

## PLASTIC SPRAY BOTTLES



### PLASTIC SPRAY BOTTLES

◆ 28 oz/828 ml

ITEM	DESCRIPTION	UOM	CASE
PSR-9	Green	Each	50
PSR-9B	Blue	Each	50
PSR-9R	Red	Each	50
PSR-9W	White	Each	50
PSR-9Y	Yellow	Each	50

IDEAL FOR COLOR-CODED CLEANING SYSTEMS

## BOX CUTTER



### RETRACTABLE BOX CUTTER

- ◆ Handy for opening boxes or slicing cardboard
- ◆ Blade retracts into metal safety sleeve

ITEM	DESCRIPTION	UOM	CASE
BXC-4	4"L	Doz	5/50
BXC-B100	Replacement Blade, 100-Pcs/Pk	Pack	5/50

## UTILITY APRONS



### DISHWASHING APRONS

*The easy on-and-off, full-length dishwashing aprons repel spills and splashes, keeping uniforms dry and presentable throughout a shift.*

- ◆ Water resistant
- ◆ Black apron is lightweight nylon/PVC/polyester blend
- ◆ Brown apron is heavyweight vinyl with faux leather front

ITEM	DESCRIPTION	SIZE	UOM	CASE
BAW-2540BK	Black	25-1/2"W x 40"L	Each	12/60
BAW-2740BN	Brown	27-1/2"W x 40"L	Each	12/60



### HEAVY VINYL BLACK APRONS

ITEM	DESCRIPTION	SIZE	UOM	CASE
BA-HN	Heavy Vinyl w/Pocket	26-1/2"W x 41-1/4"L	Each	12/24
BA-LA	Latex	37"W x 44-1/2"L	Each	12

**UTILITY PAILS**

- ◆ Pour spout and easy-lift handle
- ◆ Easily gauge capacity with molded-in graduation marks

ITEM	DESCRIPTION	UOM	CASE
UPP-10G	10 Qt, Gray	Each	1/12
UPP-10R	10 Qt, Red	Each	1/12
UPP-14G	14 Qt, Gray	Each	1/12
UPP-14R	14 Qt, Red	Each	1/12



Molded-in graduation marks

**UTILITY PAILS, BUCKETS & TOWELS**



UPP-14G



UPP-10R



**CLEANING BUCKETS**

- ◆ GREEN = soap solution
- ◆ RED = sanitizing solution
- ◆ Not for use with food products

ITEM	DESCRIPTION	UOM	CASE
PPL-3G	3 Qt, Green	Each	12
PPL-3R	3 Qt, Red	Each	12
PPL-6G	6 Qt, Green	Each	12
PPL-6R	6 Qt, Red	Each	12



PPL-6R



PPL-6G

**MICROFIBER BAR & KITCHEN TOWELS**

- ◆ Lightweight, absorbent and quick drying microfiber
- ◆ BTM-16AC colors: white, green, yellow, blue, orange and red
- ◆ Each pack includes hanging hook for easy display & contains six (6) pieces

ITEM	DESCRIPTION	UOM	CASE
BTM-16AC	16" x 16", Assorted Colors	Pack	1/20
BTM-16W	16" x 16", White	Pack	1/20



ABSORBENT MICROFIBER

BRIGHTER COLORS

BTM-16AC

**COTTON GLASS-POLISHING TOWEL**

- ◆ Absorbent 100% cotton
- ◆ Lint-free and non-abrasive; gentle on glass & non-streaking
- ◆ Effectively picks up dirt and dust
- ◆ Red stripe towel can be designated for a specific station or use, or to prevent cross-contamination

ITEM	DESCRIPTION	UOM	CASE
BTGP-21	16" x 29", Red Pinstripes	Doz	10/20



ALL-WHITE MICROFIBER 6-PACK

BTM-16W

**COTTON HERRINGBONE TOWEL**

- ◆ Super absorbent 100% cotton
- ◆ Ideal for wiping down bar top, tables or countertops
- ◆ Green stripe towel can be designated for a specific station or use, or to prevent cross-contamination

ITEM	DESCRIPTION	UOM	CASE
BTH-2028G	20" x 28"	Doz	10/20



BTGP-21

100% COTTON



BTH-2028G

**WHITE COTTON BAR TOWEL**

- ◆ 100% cotton

ITEM	DESCRIPTION	UOM	CASE
BTW-30	16" x 19"	Doz	10/20



BTW-30

SPONGES

NEW

SP-C64Y



3 pieces per pack

NEW

SP-SC63



3 pieces per pack



SP-96N



6 pieces per pack



SPG-50



1 piece per pack

CELLULOSE SPONGE

- ◆ Biodegradable
- ◆ Each pack contains three (3) pieces

ITEM	DESCRIPTION	UOM	CASE
SP-C64Y	6"L x 4-1/4"W x 1-1/2"H	Pack	10

DUAL-SURFACE SCRUB SPONGE

- ◆ General duty
- ◆ Each pack contains three (3) pieces

ITEM	DESCRIPTION	UOM	CASE
SP-SC63	6"L x 3-5/8"W	Pack	10

NYLON SCOURING PADS

- ◆ Each pack contains six (6) pieces

ITEM	DESCRIPTION	UOM	CASE
SP-96N	6" x 9-3/8" Pack	Pack	1/60

STAINLESS STEEL SPONGES

- ◆ Heavy duty
- ◆ Each pack contains one (1) piece

ITEM	DESCRIPTION	UOM	CASE
SPG-50	50g	Each	12/144
SPG-105	105g	Each	12/72

BRUSHES

NEW

AVAILABLE IN JULY 2020



BRN-52



Dual high-low bristles

NEW

BPA FREE

BRB-12



NEW

BPA FREE

BRV-10



AVAILABLE IN JULY 2020

NEW

BPA FREE

BRC-14Y



NAIL CLEANING BRUSH

- ◆ Dual high-low bristles for more effective cleaning
- ◆ Easy-grip contoured handle
- ◆ Molded-in bristles won't pull out

ITEM	DESCRIPTION	UOM	CASE
BRN-52	5-3/4"L x 2"W	Each	12/48

BOTTLE CLEANING BRUSH

- ◆ Ergonomic handle helps to reduce strain when washing bottles, glasses, pitchers/carafes
- ◆ Soft, durable bristles effectively remove residue without scratching
- ◆ Easily reaches into narrow bottle necks and inner corners

ITEM	DESCRIPTION	COLOR	UOM	CASE
BRB-12	12"L x 2-3/4" Dia	White	Each	12/48

VEGETABLE CLEANING BRUSH

- ◆ Firm bristles effectively remove dirt and impurities from vegetable skins
- ◆ Circular opening surrounds cucumbers, carrots or zucchini for a thorough, all-around cleaning
- ◆ Comfortable, easy-grip ergonomic handle

ITEM	DESCRIPTION	COLOR	UOM	CASE
BRV-10	9-1/4"L x 4-3/4"W	White	Each	12/48

COUNTER CLEANING BRUSH

- ◆ Synthetic bristles will not damage counter surfaces
- ◆ Ergonomic handle design for ultimate comfort

ITEM	DESCRIPTION	UOM	CASE
BRC-14Y	14-1/4"L	Each	12

**HAACP COLOR-CODED CUTTING BOARD BRUSHES**

ITEM	DESCRIPTION	UOM	CASE
CBR-WT	White	Each	24/96
CBR-BN	Brown	Each	24/96
CBR-BU	Blue	Each	24/96
CBR-GR	Green	Each	24/96
CBR-RD	Red	Each	24/96
CBR-YL	Yellow	Each	24/96

**BRUSHES**



CBR-SERIES



**BEER MUG WASHER**

Eliminate hand-scrubbing glassware with Winco's Beer Mug Washer. The long-lasting nylon bristles are tough enough to get out grime, yet soft enough to not scratch or damage glass. Four suction feet hold to surfaces, preventing movement while in use.

- ◆ Features one glass washer in the center with additional scrubbing bristles on the sides
- ◆ Wide enough to accommodate a beer mug & the handle
- ◆ Dirty water can be drained through detachable hose
- ◆ Durable plastic construction at space-saving size



GWB-1

ITEM	DESCRIPTION	UOM	CASE
GWB-1	Beer Mug Washer	Each	1/6

**GLASS WASHER BRUSHES**

- ◆ Four suction feet provide stability on slippery surfaces
- ◆ Dishwasher safe



GWB-3

GWB-3-BR

ITEM	DESCRIPTION	UOM	CASE
GWB-3	3 Brushes with Base	Each	1/12
GWB-3-BR	Brush for GWB-3	Each	1/100

**COFFEE DECANTER BRUSH**

- ◆ Brush head: 1-1/4" diameter



CDB-11

BR-24

BR-25

BR-28

ITEM	DESCRIPTION	UOM	CASE
CDB-11	11" O.L.	Each	12/96

**EQUIPMENT BRUSHES**

ITEM	DESCRIPTION	UOM	CASE
BR-24	24-1/2" L-Shaped Fryer Brush	Each	12/96
BR-25	25" Urn Brush	Each	12/96
BR-28	28-1/4" Kettle Valve Brush	Each	12/96

**POT SCRUBBING BRUSHES**

- ◆ Plastic handle with nylon bristles

**ALL PURPOSE CLEAN-UP BRUSHES**

ITEM	DESCRIPTION	UOM	CASE
BRN-8P	8"	Each	12/72
BRN-20P	20"	Each	12/72



BRN-8P

BRN-20P

**POT BRUSHES**

- ◆ Wooden handle with coir bristles

ITEM	DESCRIPTION	UOM	CASE
BRP-10	10"	Each	12/72
BRP-20	20"	Each	6/48



BRP-10

BRP-20



## GRILL MAINTENANCE



BR-27



BR-30



BR-31



BR-21



BR-10



BR-36W



BR-60W



BR-9



BR-12

### PIZZA OVEN SCRAPER

- ◆ Carbon wire brush and scraper

ITEM	DESCRIPTION	UOM	CASE
BR-27	Scraper with 27" Hdl	Each	12

### PIZZA OVEN/BROILER BRUSH

- ◆ Stiff stainless steel wire bristles make cleaning heavy oven residue effortless
- ◆ Quick and easy removal of heavy carbon deposits, rust and burned-on food buildup

ITEM	DESCRIPTION	UOM	CASE
BR-30	Brush w/30" Hdl	Each	8/32

### COMMERCIAL BROILER BRUSH

- ◆ 1-1/4" L steel wire bristles
- ◆ Beechwood brush base (7-11/16"L x 2-19/32"W x 1-1/64"H)
- ◆ 3/4" diameter zinc-plated iron handle

ITEM	DESCRIPTION	UOM	CASE
BR-31	31" O.L.	Each	1/12



### DUAL-HEAD BRUSH

- ◆ 1-1/2" L steel wire bristles on thick brush
- ◆ 1-1/4" L flat steel wire bristles on thin brush

ITEM	DESCRIPTION	UOM	CASE
BR-21	Dual-Headed Brush with 28" S/S Handle	Each	6

### PIZZA OVEN BRUSH HEAD

- ◆ Brass bristles with scraper

ITEM	DESCRIPTION	UOM	CASE
BR-10	Brush Head, 10-1/4" x 1-3/8" x 1-3/4"	Each	12/48
BR-36W	36" Wdn Hdl fits BR-10	Each	48
BR-60W	55" Wdn Hdl fits BR-10	Each	6/24

### BUTCHER BLOCK BRUSH

ITEM	DESCRIPTION	UOM	CASE
BR-9	Steel Bristles	Each	6/12

### OVEN & GRILL/BBQ BRUSH

ITEM	DESCRIPTION	UOM	CASE
BR-12	12" O.L., Brass Bristles	Each	12/72



### HEAVY-DUTY ALUMINUM GRILL SCRAPER

This large grill scraper with 6" wide blade features an ergonomic top-grip positioned behind the splash-guard, designed for efficient, anti-fatigue handling.

- ◆ Sharp 6" wide blade
- ◆ Dual-grip to apply added pressure when removing grease and grime from flat tops or griddles
- ◆ Splash-guard positioned above scraper blade deflects and helps collect debris for easy cleanup

ITEM	DESCRIPTION	BLADE	UOM	CASE
SCRP-14	16"L x 6"W x 4-1/2"H, NSF		Each	1/12
SCRP-6B	Replacement Blade for SCR-14, 6-Pcs/Pk		Pack	1/12

### ALUMINUM GRILL SCRAPER

A great way to clean the grill quickly and safely. The handle is designed to keep hands and fingers away from the hot grill surface.

ITEM	DESCRIPTION	BLADE	UOM	CASE
SCRP-16	16" Scraper	5"	Each	1/6
SCRP-5B	Replacement Blade for SCR-16		Each	12/48

### ALUMINUM GRILL SCRAPER

Scrape away grease and stuck-on-food with ease.

ITEM	DESCRIPTION	BLADE	UOM	CASE
SCRP-12	12" Alu Scraper	4"	Each	12/72
SCRP-4B	Replacement Blades for SCR-12, 10-Pcs/Pk		Pack	10/100

### GRILL CLEANERS

ITEM	DESCRIPTION	UOM	CASE
GSH-1	Grill Screen Holder, 5" x 2-3/4"	Each	12/48
GSN-4	Grill Screen, 4" x 5-1/2", 20-Pcs/Pk, Fits with GSH-1	Pack	20/80
GBH-2	Grill Brick Holder, 7" x 3-1/2"	Each	6/72
GBK-348	Grill Brick, 3-1/2" x 4" x 8", Fits with GBH-2	Doz	1

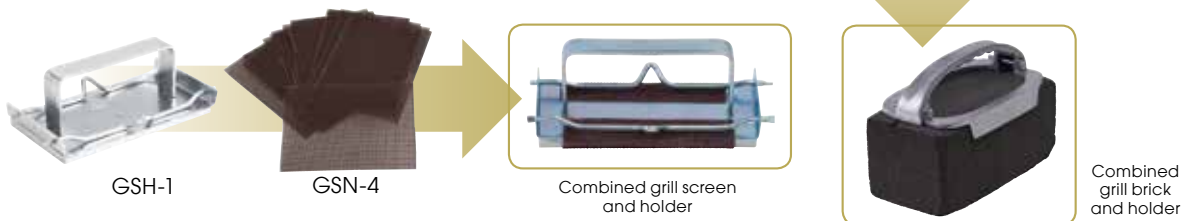

## GRILL MAINTENANCE



### MINI UTILITY BRUSHES

- ◆ Ideal for cleaning ceramic tiles and narrow spaces

ITEM	DESCRIPTION	UOM	CASE
BR-7B	7" O.L., Brass Bristles	Each	48/576
BR-7S	7" O.L., S/S Wire Bristles	Each	48/576

### SCRATCH BRUSHES

ITEM	DESCRIPTION	UOM	CASE
BR-319	14" O.L., Steel Bristles	Doz	1/12
BR-500	20" O.L., Wire Bristles	Each	6/48

### UTILITY & SCRATCH BRUSHES



**RESTROOM NECESSITIES**



TD-600



TD-700



TD-300



TD-330



TD-500



AFD-1K



AFD-1



SD-100K



SD-100



**PAPER TOWEL CABINETS**

- ◆ Dispenses 400 C-Fold or 525 M-fold towels (3-1/8" to 3-13/16") without adjustments or adapters

ITEM	DESCRIPTION	UOM	CASE
TD-600	White Epoxy-Coated Metal	Each	1/6
TD-700	Stainless Steel	Each	1/6

**MULTI-FOLD PAPER TOWEL DISPENSER**

- ◆ Dispenser accommodates paper pack size of 8-1/2" x 3-1/8" x 6" (maximum of 200 pieces) with an approximate weight of 0.88 lbs

ITEM	DESCRIPTION	UOM	CASE
TD-300	Fits M/C-Fold	Each	1/10

**CENTER-PULL PAPER TOWEL DISPENSER**

- ◆ Dispenser accommodates a paper roll size of 8" diameter with an approximate weight of 3.19 lbs

ITEM	DESCRIPTION	UOM	CASE
TD-330	Center-Pull	Each	1/6

**PAPER TOWEL DISPENSER, LEVER HANDLE**

- ◆ Dispenser accommodates a paper roll size of 8" diameter with an approximate weight of 3.30 lbs

ITEM	DESCRIPTION	UOM	CASE
TD-500	Fits 8"Dia Paper Roll	Each	1/3



**AUTOMATIC AIR FRESHENER**

- ◆ Fully programmable dispenser
- ◆ Sprays at automatic intervals of either 5, 10, 15 or 30 minutes
- ◆ Working time setting options are day, night or 24 hours
- ◆ Accommodates standard size 6.6 oz refill sprays (not included)

ITEM	DESCRIPTION	UOM	CASE
AFD-1K	Black	Each	6/24
AFD-1	White	Each	6/24

**MANUAL BULK SOAP DISPENSER**

- ◆ Capacity 1 Liter
- ◆ Wall mount

ITEM	DESCRIPTION	UOM	CASE
SD-100K	Black	Each	1/24
SD-100	White	Each	1/24

**RESTROOM NECESSITIES**

**TWIN ROLLS TOILET TISSUE DISPENSER**

- ◆ Dispenser accommodates two tissue paper rolls, each with an approximate size of 9-1/2" Dia x 4"H and each with an approximate weight of 1.71 lbs

ITEM	DESCRIPTION	UOM	CASE
TD-220	Twin Rolls	Each	1/3



TD-220

**JUMBO ROLL PAPER DISPENSERS**

- ◆ Dispenser accommodates a tissue paper roll with an approximate weight of 4.18 lbs

ITEM	DESCRIPTION	UOM	CASE
TD-120	14"Dia	Each	1/3
TD-120S	11"Dia	Each	1/6



TD-120S



**TOILET TISSUE HOLDERS**

- ◆ Chrome-plated steel

ITEM	DESCRIPTION	UOM	CASE
TTH-1	Single Roll	Each	1/36
TTH-2	Double Roll	Each	1/24



TTH-1



TTH-2

**TOILET SEAT COVERS**

- ◆ Easy to use and disposable

ITEM	DESCRIPTION	UOM	CASE
TSC-10	Half-Fold Dispenser	Each	20
TSC-250	Half-Fold Covers, 250-Pcs/Bag	Bag	1/20



TSC-10



TSC-250



**TOILET BRUSHES WITH PLASTIC HANDLE**

- ◆ Non-scratch bristles

ITEM	DESCRIPTION	UOM	CASE
BR-15	15" O.L. Brush	Each	12/48
BR-15SET	15-3/4" O.L. Brush with Caddy	Set	1/24



**ANGLED-TIP TOILET BRUSH WITH WOODEN HANDLE**

- ◆ Longer reach helps reduce hunching over
- ◆ Angled tip of brush to clean under the rim



ITEM	DESCRIPTION	UOM	CASE
BR-21W	21" O.L.	Each	24

**RUBBER PLUNGER WITH WOODEN HANDLE**

- ◆ Long, smooth handle

ITEM	DESCRIPTION	UOM	CASE
TP-300	19" O.L.	Each	1/48

**URINAL SCREEN WITH DEODORIZER BLOCK**

- ◆ Eucalyptus scent

ITEM	DESCRIPTION	UOM	CASE
USF-4	Screen & Deodorizer	Each	12/144



BR-15

BR-21W

BR-15SET

TP-300



USF-4



## HOOD FILTERS



POPULAR  
FOOD TRUCK  
SIZES!

## STAINLESS STEEL HOOD FILTERS

Essential to any kitchen, these hood filters are durable and long-lasting, helping to prevent unsafe working conditions.

- ◆ Easily clean with degreaser, soap and water, or in the dishwasher

ITEM	DESCRIPTION	UOM	CASE
HFS-1616	16"W x 16"H	Each	1/6
HFS-1620	16"W x 20"H	Each	1/6
HFS-1625	16"W x 25"H	Each	1/6
HFS-2016	20"W x 16"H	Each	1/6
HFS-2020	20"W x 20"H	Each	1/6
HFS-2025	20"W x 25"H	Each	1/6
HFS-2520	25"W x 20"H	Each	1/6



## JANITORIAL ACCESSORIES

### ALUMINUM PAIL OPENER

- ◆ Open large buckets and pails with ease
- ◆ Built-in hammer assists in closing lids for a tight seal

ITEM	DESCRIPTION	UOM	CASE
POA-8	8-7/16"L x 2-3/4"W x 1-7/16"D	Each	6/72

### POLYPROPYLENE OVERFLOW PIPES

- ◆ Rubber head provides snug, secure fit

ITEM	DESCRIPTION	UOM	CASE
OP-7	7"L x 1"Dia	Each	24/288
OP-11	11"L x 1"Dia	Each	12/144

### SINK STRAINER

- ◆ Stainless steel

ITEM	DESCRIPTION	UOM	CASE
SIK-3	3"Dia w/Stopper	Each	24/144

### RUBBER SCRAP BLOCK

ITEM	DESCRIPTION	UOM	CASE
RSB-6	6-1/2"Dia x 4"H	Each	12

### PLASTIC FUNNELS

ITEM	DESCRIPTION	UOM	CASE
PF-8	4"Dia	Each	6/324
PF-16	5-1/4"Dia	Each	6/324
PF-32	6-1/4"Dia	Each	6/216

### WIDE MOUTH FUNNELS & REMOVABLE STRAINERS

- ◆ Stainless steel mirror finish for SF-5 and SF-6

ITEM	DESCRIPTION	UOM	CASE
SF-5	5"Dia	Each	12/72
SF-6	5-3/4"Dia	Each	12/72
SF-6S	Strainer for SF-5 and SF-6	Each	120/480



## WIRE SHELVING SETS

- ◆ Shelving set includes four (4) shelves and four (4) 72" high posts
- ◆ Heavy-duty wire construction
- ◆ Bright chrome-plated / epoxy-coated finish to reduce dust and dirt accumulation
- ◆ Easy to assemble, no tools required
- ◆ Withstands temperatures from -100°F to 500°F
- ◆ Capacity: up to 1,400 lbs per set

### CHROME-PLATED WIRE SHELVING SET

- ◆ NSF listed for use in dry storage and heated environments

ITEM	DESCRIPTION	UOM	CASE
VCS-1836	18"W x 36"L	Set	1
VCS-1848	18"W x 48"L	Set	1
VCS-2436	24"W x 36"L	Set	1
VCS-2448	24"W x 48"L	Set	1



VCS-SERIES NSF

### EPOXY-COATED WIRE SHELVING SET

- ◆ NSF listed for use in all environments, including humid areas

ITEM	DESCRIPTION	UOM	CASE
VEXS-1836	18"W x 36"L	Set	1
VEXS-1848	18"W x 48"L	Set	1
VEXS-2436	24"W x 36"L	Set	1
VEXS-2448	24"W x 48"L	Set	1



VEXS-SERIES NSF

### 3-TIER WIRE SHELVING CARTS

Winco's sturdy shelving now comes in a full cart set! Unlike traditional carts that have fixed heights, these wire shelving carts are height-adjustable to fit your storage needs.

- ◆ Includes three (3) adjustable-height shelves
- ◆ Capacity up to 800 Lbs
- ◆ Step-lock feature on two casters
- ◆ Ships knocked down

ITEM	DESCRIPTION	UOM	CASE
VCCD-1836B	18"W x 36"L x 42"H	Set	1
VCCD-2448B	24"W x 48"L x 42"H	Set	1



VCCD-1836B



VCCD-SERIES

### MOBILE SHELVING EXTENSION HANDLE

- ◆ Use extension handles on mobile units for easy transport
- ◆ Includes two (2) sleeve clips per handle

ITEM	DESCRIPTION	UOM	CASE
VCH-14	14"W	Each	12
VCH-18	18"W	Each	12
VCH-21	21"W	Each	12
VCH-24	24"W	Each	12



VCH-24

## WIRE SHELVES

- ◆ NSF listed for use in dry storage and heated environments
- ◆ Heavy-duty wire construction
- ◆ Bright chrome-plated finish reduces dust and dirt accumulation
- ◆ Mix-and-match the various sizes to suit any need
- ◆ Easy to assemble, no tools required
- ◆ Capacities:  
under 48" long - up to 850 lbs/shelf  
over 48" long - up to 600 lbs/shelf
- ◆ Includes four (4) sleeve clips per shelf



**NSF** VC-SERIES SHELVES



Customize the Chrome-Plated Wire Shelves to accommodate all of your storage needs



**NSF** VC-SERIES POSTS



VCB-SERIES WALL MOUNT BRACKET



VC-HK



## CHROME-PLATED WIRE SHELVES

- ◆ Withstands temperatures from -100°F to 500°F

### ◆ Must buy full case quantity

- ◆ NSF listed

ITEM	DESCRIPTION - W x L	UOM	CASE
VC-1424	14" x 24"	Each	2
VC-1430	14" x 30"	Each	2
VC-1436	14" x 36"	Each	2
VC-1448	14" x 48"	Each	2
VC-1460	14" x 60"	Each	2
VC-1472	14" x 72"	Each	2
VC-1824	18" x 24"	Each	2
VC-1830	18" x 30"	Each	2
VC-1836	18" x 36"	Each	2
VC-1842	18" x 42"	Each	2
VC-1848	18" x 48"	Each	2
VC-1854	18" x 54"	Each	2
VC-1860	18" x 60"	Each	2
VC-1872	18" x 72"	Each	2
VC-2124	21" x 24"	Each	2
VC-2130	21" x 30"	Each	2
VC-2136	21" x 36"	Each	2
VC-2148	21" x 48"	Each	2
VC-2160	21" x 60"	Each	2
VC-2172	21" x 72"	Each	2
VC-2424	24" x 24"	Each	2
VC-2430	24" x 30"	Each	2
VC-2436	24" x 36"	Each	2
VC-2442	24" x 42"	Each	2
VC-2448	24" x 48"	Each	2
VC-2454	24" x 54"	Each	2
VC-2460	24" x 60"	Each	2
VC-2472	24" x 72"	Each	2



## CHROME-PLATED POSTS

- ◆ For wire shelving
- ◆ Withstands temperatures from -100°F to 500°F

### ◆ Must buy full case quantity

- ◆ NSF listed

ITEM	DESCRIPTION	UOM	CASE
VC-8P	8"H	Each	4
VC-34P	34"H	Each	4
VC-48P	48"H	Each	4
VC-54P	54"H	Each	4
VC-63P	63"H	Each	4
VC-72P	72"H	Each	4
VC-86P	86"H	Each	4

## CHROME-PLATED WALL MOUNT BRACKETS

- ◆ Brackets for mounting single wire shelving

### ◆ Must buy full case quantity

ITEM	DESCRIPTION	UOM	CASE
VCB-14	14"W	Pair	2
VCB-18	18"W	Pair	2
VCB-21	21"W	Pair	2
VCB-24	24"W	Pair	2

## S/N-STYLE HOOK FOR CHROME-PLATED SHELVING

- ◆ Holds shelves together when standing next to each other

ITEM	DESCRIPTION	UOM	CASE
VC-HK	S/N Hook for VC-series Shelves	Each	20/200

### EPOXY-COATED WIRE SHELVES

◆ Withstands temperatures from -100°F to 500°F

◆ **Must buy full case quantity**

◆ NSF listed

ITEM	DESCRIPTION - W x L	UOM	CASE
VEX-1424	14" x 24"	Each	2
VEX-1430	14" x 30"	Each	2
VEX-1436	14" x 36"	Each	2
VEX-1448	14" x 48"	Each	2
VEX-1460	14" x 60"	Each	2
VEX-1472	14" x 72"	Each	2
VEX-1824	18" x 24"	Each	2
VEX-1830	18" x 30"	Each	2
VEX-1836	18" x 36"	Each	2
VEX-1842	18" x 42"	Each	2
VEX-1848	18" x 48"	Each	2
VEX-1854	18" x 54"	Each	2
VEX-1860	18" x 60"	Each	2
VEX-1872	18" x 72"	Each	2
VEX-2124	21" x 24"	Each	2
VEX-2130	21" x 30"	Each	2
VEX-2136	21" x 36"	Each	2
VEX-2148	21" x 48"	Each	2
VEX-2160	21" x 60"	Each	2
VEX-2172	21" x 72"	Each	2
VEX-2424	24" x 24"	Each	2
VEX-2430	24" x 30"	Each	2
VEX-2436	24" x 36"	Each	2
VEX-2442	24" x 42"	Each	2
VEX-2448	24" x 48"	Each	2
VEX-2454	24" x 54"	Each	2
VEX-2460	24" x 60"	Each	2
VEX-2472	24" x 72"	Each	2



### WIRE SHELVES

- ◆ NSF listed for use in all environments, including humid areas
- ◆ Heavy-duty wire construction
- ◆ Bright epoxy-coated finish reduces dust and dirt accumulation
- ◆ Mix-and-match the various sizes to suit any need
- ◆ Easy to assemble, no tools required
- ◆ Capacities:  
under 48" long - up to 850 lbs/shelf  
over 48" long - up to 600 lbs/shelf
- ◆ Includes four (4) sleeve clips per shelf



VEX-SERIES SHELVES NSF



Customize the Epoxy Coated Wire Shelves to accommodate all of your storage needs



VEX-SERIES POSTS NSF

### EPOXY-COATED POSTS

◆ For wire shelving

◆ Withstands temperatures from -100°F to 500°F

◆ **Must buy full case quantity**

◆ NSF listed

ITEM	DESCRIPTION	UOM	CASE
VEX-8P	8"H	Each	4
VEX-34P	34"H	Each	4
VEX-48P	48"H	Each	4
VEX-54P	54"H	Each	4
VEX-63P	63"H	Each	4
VEX-72P	72"H	Each	4
VEX-86P	86"H	Each	4



### EPOXY-COATED WALL MOUNT BRACKETS

◆ Brackets for mounting single wire shelving

◆ **Must buy full case quantity**

ITEM	DESCRIPTION	UOM	CASE
VEXB-14	14"W	Pair	2
VEXB-18	18"W	Pair	2
VEXB-21	21"W	Pair	2
VEXB-24	24"W	Pair	2

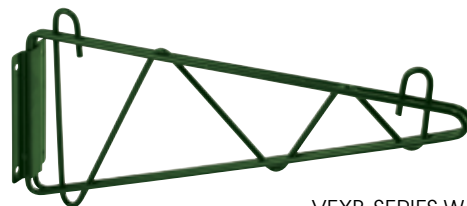

VEXB-SERIES WALL MOUNT BRACKET

### S/N-STYLE HOOK FOR EPOXY-COATED SHELVING

◆ Holds shelves together when standing next to each other

ITEM	DESCRIPTION	UOM	CASE
VEX-HK	S/N Hook for VEX-series Shelves	Each	20/200



VEX-HK



## SHELVING MATS



VM-SERIES

### SHELVING MATS

- ◆ Creates a solid surface for wire shelves to prevent small debris and leaks from falling through
- ◆ Protects epoxy coated shelves from scratches
- ◆ 0.75mm thick polypropylene
- ◆ 4-Pcs/Pk

ITEM	DESCRIPTION - W x L	UOM	CASE
VM-1460	14" x 60"	Pack	4
VM-1824	18" x 24"	Pack	4

## SHELVING PARTS & ACCESSORIES



VC-LF



VC-SC2



VC-FP



VC-CT



VC-CTB

### PARTS FOR WIRE SHELVING

- ◆ Secure shelving to floors
- ◆ Each pack contains four (4) pieces

ITEM	DESCRIPTION	UOM	CASE
VC-LF	Shelf Levelling Foot	Pack	1/100
VC-SC2	Shelf Sleeve Clips	Pack	1/150

### SHELVING FOOT PLATE

- ◆ Secure shelving to floors
- ◆ Each pack contains four (4) pieces

ITEM	DESCRIPTION	UOM	CASE
VC-FP	Foot Plate w/Screws	Pack	1/100

### CASTERS FOR WIRE SHELVING

- ◆ 5" diameter

ITEM	DESCRIPTION	UOM	CASE
VC-CT	Caster	Each	4/24
VC-CTB	Casters with Brake	Each	4/24

## DUNNAGE RACKS



ASDR-1436

**NSF** ASDR-SERIES



ADRK-2036

**NSF** ADRK-SERIES

### ALUMINUM DUNNAGE RACKS

- ◆ Great for storing items off the floor in any environment
- ◆ NSF listed

ITEM	DESCRIPTION	W x L	HT	UOM	CASE
ASDR-1424	Holds up to 1200 Lbs	14" x 24"	8"	Each	8
ASDR-1436	Holds up to 900 Lbs	14" x 36"	8"	Each	6
ASDR-1448	Holds up to 900 Lbs	14" x 48"	8"	Each	6
ASDR-2036	Holds up to 1800 Lbs	20" x 36"	8"	Each	6
ASDR-2048	Holds up to 1500 Lbs	20" x 48"	8"	Each	6
ASDR-2060	Holds up to 1200 Lbs	20" x 60"	8"	Each	6
ADRK-2036	Holds up to 1800 Lbs	20" x 36"	12"	Each	6
ADRK-2048	Holds up to 1500 Lbs	20" x 48"	12"	Each	6
ADRK-2060	Holds up to 1200 Lbs	20" x 60"	12"	Each	6



## CAN STORAGE RACKS

### HEAVY-DUTY ALUMINUM CAN STORAGE RACKS

The can racks are designed with angled shelves for first-in first-out stock rotation.

- ◆ Sturdy aluminum construction
- ◆ Designed to hold #10 cans or 216 #5 cans
- ◆ First-in, first-out design for proper stock rotation
- ◆ Angled shelves with lifted front edges prevent cans from rolling out; loads from front or rear
- ◆ NSF listed

### STATIONARY CAN STORAGE RACK

- ◆ 9-tier sturdy aluminum construction
- ◆ Holds up to (162) #10 cans or (216) #5 cans
- ◆ 7" spacing between each tier
- ◆ Ships knocked down
- ◆ Fully assembled dimensions: 26-3/8"L x 34-3/4"W x 82-1/8"H

ITEM	DESCRIPTION	UOM	CASE
ALCR-9	9-Tier, Knocked Down	Each	1

CAPACITY UP TO 1,200 LBS

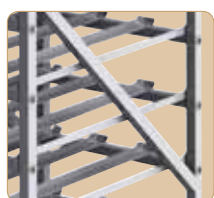

Sturdy cross-braces



Reinforced frame, stainless steel levelers



Tiers slant forward and raised edges prevent cans from rolling out



FITS STANDARD #10 AND #5 CANS

NEW

ALCR-9 NSF

### MOBILE UNDER-COUNTER CAN STORAGE RACK

- ◆ 3-tier sturdy aluminum construction
- ◆ Holds up to (36) #10 or (45) #5 cans
- ◆ Heavy gauge aluminum worktop
- ◆ 3" swivel casters for mobility, 2 with brake
- ◆ Fully assembled dimensions: 26-3/4"L x 25-1/2"D x 33-1/2"H

ITEM	DESCRIPTION	UOM	CASE
ALCR-3M	3-Tier	Each	1

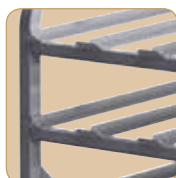

Tiers slant forward and raised edges prevent cans from rolling out



NEW

AVAILABLE IN JULY 2020

ALCR-3M NSF



Winco's exclusive Weld2 System features fail-safe rigidity through both bolting and welding at all critical joints to prevent warping with long term, high-traffic use.



Specialty bolts secure each joint

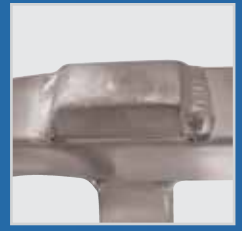

Bolt caps are welded over completely to form extra-strength juncture

## HEAVY-DUTY ALUMINUM 20-TIER SHEET PAN RACK



**FULLY WELDED**



Double cross bars for extra strength

**NSF** AWRK-20HBK

## HEAVY DUTY 20-TIER END-LOAD SHEET PAN RACK, WITH BRAKES

*Designed with heavy-duty welded construction and a reinforced base-frame to ensure stability and long-lasting performance.*

- ◆ 20-tier sturdy aluminum construction
- ◆ Designed to hold and transport (20) full-size (18" x 26") sheet pans or 40 (13" x 18") half-size sheet pans
- ◆ 5" dia, full-swivel casters; two (2) with brake
- ◆ Capacity: up to 1,000 Lbs
- ◆ 3" spacing between each tier
- ◆ Fully assembled dimensions: 21-3/4"L x 26"W x 70-1/2"H
- ◆ NSF listed

ITEM	DESCRIPTION	UOM	CASE
AWRK-20HBK	20-Tier, Welded	Each	1
AWRC-5H	Caster for AWRK-20HBK, Heavyweight	Each	12
AWRC-5HK	Caster w/Brake for AWRK-20HBK, Heavyweight	Each	12

**CAPACITY UP TO 1,000 LBS**



AWRC-5HK 5" plate caster with brake

## UNIVERSAL CASTERS

**5" DIA WHEEL** will raise height of equipment by 6"



CT-1 CT-1B CT-23 CT-23B



CT-33 CT-33B CT-44 CT-44B

## UNIVERSAL CASTERS, EXTRA HEAVY-DUTY

- ◆ Use with most appliances including ranges or walk-in refrigerators
- ◆ Polyurethane, skid-free - will not mark floors
- ◆ High-quality grease-resistant wheel
- ◆ Temperature range from 14°F to 212°F
- ◆ Wheel capacity: 220 lbs each
- ◆ CT-1 and CT-1B fit standard 1-5/8" or 1-1/2" tubing
- ◆ Two (2) pieces per set

ITEM	DESCRIPTION	PLATE SIZE	UOM	CASE
CT-1	Worktable Stem Caster Set		Set	1/12
CT-1B	Worktable Stem Caster Set w/Brake		Set	1/12
CT-23	Universal Plate Caster Set	2-3/8" x 3-5/8"	Set	1/12
CT-23B	Universal Plate Caster Set w/ Brake	2-3/8" x 3-5/8"	Set	1/12
CT-33	Universal Plate Caster Set	3-1/2" x 3-1/2"	Set	1/12
CT-33B	Universal Plate Caster Set w/ Brake	3-1/2" x 3-1/2"	Set	1/12
CT-44	Universal Plate Caster Set	4" x 4"	Set	1/12
CT-44B	Universal Plate Caster Set w/Brake	4" x 4"	Set	1/12

Made for the most demanding restaurant kitchens, these aluminum sheet pan racks accommodate standard full-size 18" x 26" sheet pans, or twice the capacity with half-size 18" x 13" pans.

## ALUMINUM SHEET PAN RACKS



### 10-TIER SHEET PAN RACKS

- ◆ Sturdy aluminum construction
- ◆ Hold and transport 10 full-size (18" x 26") sheet pans
- ◆ 5" dia, full-swivel casters; two (2) with brake
- ◆ Capacity: up to 400 Lbs
- ◆ 3" spacing between each tier
- ◆ Ships welded or knocked down
- ◆ Fully assembled dimensions: 21"L x 26-1/2"D x 39"H
- ◆ NSF listed

ITEM	DESCRIPTION	UOM	CASE
AWRK-10	10-Tier, Welded	Each	1
ALRK-10BK	10-Tier, Knocked Down	Each	1
ALRK-10	10-Tier w/o Brakes, Knocked Down	Each	1
ALRC-5ST	Caster for ALRK and AWRK-series	Each	12
ALRC-5STK	Caster w/Brake for ALRK & AWRK-series	Each	12



AWRK-10  
ALRK-10BK

ALRK-10

### 20-TIER END-LOAD SHEET PAN RACKS

- ◆ Sturdy aluminum construction
- ◆ Hold and transport 20 full-size (18" x 26") sheet pans
- ◆ 5" dia, full-swivel casters; two (2) with brake
- ◆ Capacity (ALRK-20R): up to 500 Lbs
- ◆ Capacity (ALRK-20 & ALRK-20BK): up to 700 Lbs
- ◆ Capacity (AWRK-20): up to 800 Lbs
- ◆ 3" spacing between each tier
- ◆ Ships welded or knocked down
- ◆ Fully assembled dimensions (ALRK-20, -20BK, AWRK-20): 21"L x 26-1/2"W x 70"H
- ◆ Fully assembled (ALRK-20R): 20-1/4"L x 26"W x 69-1/4"H
- ◆ NSF listed

ITEM	DESCRIPTION	UOM	CASE
AWRK-20	20-Tier, Welded	Each	1
ALRK-20BK	20-Tier, Knocked Down	Each	1
ALRK-20	20-Tier w/o Brakes, Knocked Down	Each	1
ALRK-20R	20-Tier, Knocked Down, ECONOMY	Each	1
ALRC-5ST	Caster for ALRK-20/-20BK & AWRK-20	Each	12
ALRC-5STK	Caster w/Brake for ALRK-20/-20BK & AWRK-20	Each	12
ALRC-5R	Caster for ALRK-20R	Each	12
ALRC-5RK	Caster w/Brake for ALRK-20R	Each	12



ALRK-20

AWRK-20  
ALRK-20BK

### 30-TIER END-LOAD SHEET PAN RACKS, WITH BRAKES

- ◆ Aluminum construction, 14 gauge
- ◆ Hold and transport 30 full-size (18" x 26") sheet pans
- ◆ 5" dia, heavyweight full-swivel casters; two (2) with brake
- ◆ Capacity: up to 700 Lbs
- ◆ 2" spacing between each tier
- ◆ Ships welded or knocked down
- ◆ Fully assembled dimensions: 21"L x 26-1/2"D x 70"H
- ◆ NSF listed

ITEM	DESCRIPTION	UOM	CASE
AWRK-30	30-Tier, Welded	Set	1
ALRK-30BK	30-Tier, Knocked Down	Set	1
ALRC-5H	Caster for ALRK-30BK, Heavyweight	Each	12
ALRC-5HK	Caster w/Brake for ALRK-30BK, Heavyweight	Each	12



AWRK-30

ALRK-20R

## ALUMINUM NESTING SHEET PAN RACKS

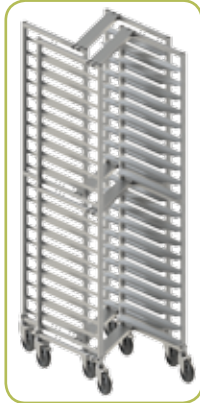



Empty racks nested together

**NSF** ALZK-20BK  
AWZK-20

## 20-TIER NESTING RACK, WITH BRAKES

*Designed with space-saving in mind, the Z-rack fits snugly with nesting racks to conserve floor space while in storage. The Z-rack accommodates standard full-size sheet pans, or double up with half-size pans.*

- ◆ 20-tier sturdy aluminum construction
- ◆ Z-frame nesting design for compact storage
- ◆ Capacity: up to 650 lbs & 20 full-size (18" x 26") sheet pans
- ◆ Full-swivel casters; two (2) with brake
- ◆ 3" spacing between each tier
- ◆ Fully assembled: 22" L x 27-1/2"W x 70"H
- ◆ NSF listed

ITEM	DESCRIPTION	UOM	CASE
 AWZK-20	20-Tier, Welded	Each	1
 ALZK-20BK	20-Tier, Knocked Down	Each	1
ALRC-5ST	Caster for ALZK & AWZK-series	Each	12
ALRC-5STK	Caster w/Brake for ALZK & AWZK-series	Each	12

## ALUMINUM SIDE-LOAD SHEET PAN RACKS



## 20-TIER SIDE-LOAD RACK, WITH BRAKES

*Designed with side-load access for alternative convenience in tight kitchen and bakery spaces.*

- ◆ 20-tier sturdy aluminum construction
- ◆ Designed to hold and transport (20) full-size (18" x 26") sheet pans
- ◆ 5" dia, full-swivel casters; two (2) with brake
- ◆ Capacity: up to 650 Lbs
- ◆ 3" spacing between each tier
- ◆ Ships welded or knocked down
- ◆ Fully assembled dimensions: 29-1/2"L x 19-1/2"W x 70-3/8"H
- ◆ NSF listed

ITEM	DESCRIPTION	UOM	CASE
 AWRS-20BK	20-Tier, Welded	Each	1
 ALRS-20BK	20-Tier, Knocked Down	Each	1
ALRC-5ST	Caster for ALZK & AWZK-series	Each	12
ALRC-5STK	Caster w/Brake for ALZK & AWZK-series	Each	12

**NSF** ALRS-20BK  
AWRS-20BK

### 26-TIER PIZZA PAN RACK, WITH BRAKES

Each tier features an extended ledge to accommodate round or square pizza pans.

- ◆ 26-tier sturdy aluminum construction
- ◆ Designed to hold and transport 17" & 19" dia round pizza pans and 16" & 17" square Sicilian pizza pans
- ◆ 5" dia, full-swivel casters; two (2) with brake
- ◆ Capacity: up to 800 Lbs
- ◆ 2" spacing between each tier
- ◆ 4-1/8" wide ledge for round or square pizza pans
- ◆ Ships welded or knocked down
- ◆ Fully assembled dimensions: 23"L x 21"W x 62-7/8"H
- ◆ NSF listed

ITEM	DESCRIPTION	UOM	CASE
AWPR-26BK	26-Tier, Welded	Each	1
ALPR-26BK	26-Tier, Knocked Down	Each	1
ALRC-5ST	Caster for ALZK & AWZK-series	Each	12
ALRC-5STK	Caster w/Brake for ALZK & AWZK-series	Each	12



ALRC-5STK  
5" caster with brake

### ALUMINUM PIZZA PAN RACKS



ALPR-26BK  
AWPR-26BK NSF

### ALUMINUM COUNTER-HEIGHT END-LOAD SHEET PAN RACK

- ◆ 15 plated steel wire slides at 1-3/4" spacing
- ◆ Stainless steel solid top is useful as a work surface, and can also help to transport bulky items
- ◆ 14 gauge 6063 aluminum with 1" extruded tube frame
- ◆ Full swivel casters, 5" diameter x 1-1/4"
- ◆ Holds 15 full-size (18" x 26") or 30 half-size (18" x 13") sheet pans (not included)
- ◆ Capacity: up to 400 lbs
- ◆ Ships knocked down
- ◆ Fully assembled: 20-7/8"L x 26-1/8"W x 31-5/8"H
- ◆ NSF listed

ITEM	DESCRIPTION	UOM	CASE
ALRK-15	15-Tier	Set	1
ALRC-5ST	Caster for ALRK and AWRK-series	Each	12
ALRC-5STK	Caster w/Brake for ALRK & AWRK-series	Each	12

### ALUMINUM SHEET PAN RACK & TRUCK



ALRK-15 NSF

### ALUMINUM SHEET PAN TRUCK

- ◆ 14 gauge 6063 aluminum with 1" extruded aluminum tube frame
- ◆ Full swivel casters, 5" diameter x 1-1/4" width
- ◆ Holds 54 full-size (18" x 26") or 108 half-size (13" x 18") sheet pans (not included)
- ◆ Ships knocked down
- ◆ Fully assembled: 28-7/8"L x 20-5/8"W x 33-3/8"H
- ◆ NSF listed

ITEM	DESCRIPTION	UOM	CASE
ALRK-3	Sheet Pan Truck	Set	1
ALRC-5P	Replacement Caster for ALRK-3	Each	12



ALRK-3 NSF

**STAINLESS STEEL  
STEAM TABLE PAN/  
FOOD PAN RACKS**



**36-TIER  
CAPACITY UP  
TO 1,000 LBS**

SRK-36

**STAINLESS STEEL STEAM TABLE PAN/FOOD PAN RACKS**

- ◆ Stainless steel construction
- ◆ Customize with a variety of steam table pans and food pans for the best configuration
- ◆ Dual-ended locking bars prevent pans from sliding out
- ◆ Caster bumpers protect walls, doors and rack during minor collisions
- ◆ Channel ledges are tightly welded to rails providing better support for pans
- ◆ 4" dia double-bearing, full-swivel casters help stabilize weight capacity
- ◆ Capacities: up to 1,000 Lbs (SRK-36) or up to 500 Lbs (SRK-12, SRK-12D)
- ◆ Ships knocked down
- ◆ 1-1/2" and 1-3/4" spacing between each tier

**FULL HEIGHT RACKS - 36-TIER**

ITEM	DESCRIPTION	SIZE	UOM	CASE
SRK-36	36-Tier END-LOAD Rack	15-1/8"L x 21-5/8"W x 63-1/4"H	Set	1

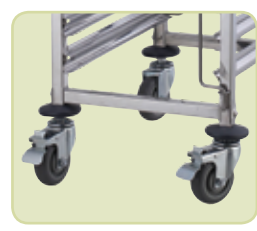

Caster bumpers protect walls, doors and rack against minor collisions



**SEE PAGE 224  
FOR STEAM  
TABLE PANS**

Customize with a variety of steam table pans and food pans for the best configuration

**UNDER-COUNTER RACKS - 12-TIER**

ITEM	DESCRIPTION	SIZE	UOM	CASE
SRK-12	12-Tier END-LOAD Rack	15-1/8"L x 21-5/8"W x 31-1/2"H	Set	1
SRK-12D	12-Tier SIDE-LOAD Rack	23-1/4"L x 26"W x 31-1/2"H	Set	1

**NEW  
SIZES**

**12-TIER  
CAPACITY UP  
TO 1,000 LBS**

**REPLACEMENT CASTERS**

ITEM	DESCRIPTION	SIZE	UOM	CASE
SRK-CT	Caster for SRK-Series		Each	4/16
SRK-CTB	Caster w/Brake for SRK-Series		Each	4/16



**NEW**

SRK-12  
Fits a combination of full, half or third-size pans



**NEW**

SRK-12D  
Fits full length pans only, two per tier



SRK-CT  
4" caster



SRK-CTB  
4" caster with brake

### SHEET PAN RACK COVERS

ITEM	DESCRIPTION	UOM	CASE
ALRK-10-CV	Cover for 10-Tier Rack	Each	1/12
ALRK-20-CV	Cover for 20-Tier and 30-Tier Racks	Each	1/12

### SHEET PAN RACK ACCESSORIES



Easily zippers on and off



ALRK-10-CV



ALRK-20-CV

### SHEET PAN RACK REPLACEMENT CASTERS

ITEM	DESCRIPTION	UOM	CASE
ALRC-5P	Caster for ALRK-3	Each	12
ALRC-5ST	Caster for ALRK & AWRK-series	Each	12
ALRC-5STK	Caster w/Brake for ALRK & AWRK-series	Each	12
ALRC-5R	Caster for ALRK-20R	Each	
ALRC-5RK	Caster w/Brake for ALRK-20R	Each	
ALRC-5H	Caster for ALRK-30BK, Heavyweight	Each	12
ALRC-5HK	Caster w/Brake for ALRK-30BK, Heavy-duty	Each	12
AWRC-5H	Caster for AWRK-20HBK, Heavy-duty	Each	12
AWRC-5HK	Caster w/Brake for AWRK-20HBK, Heavy-duty	Each	12
SRK-CT	Caster for SRK-36	Each	4/16
SRK-CTB	Caster w/ Brake for SRK-36	Each	4/16



ALRC-5P



ALRC-5ST



ALRC-5STK



ALRC-5H



ALRC-5RK



ALRC-5HK



AWRC-5HK



SRK-CTB

#### CASTER ITEM NUMBER

	ALRC-5P	ALRC-5ST	ALRC-5STK	ALRC-5E	ALRC-5EK	ALRC-5H	ALRC-5HK	ALRC-5K	ALRC-5RK	AWRC-5H	AWRC-5HK	SRK-CT	SRK-CTB
ALPR-26BK		2	2										
ALRK-10/20		4											
ALRK-10BK/15/20BK		2	2										
ALRK-20R				2	2			2	2				
ALRK-3	4												
ALRK-30BK						2	2						
ALRS-20BK		2	2										
ALZK-20BK		2	2										
AWPR-26BK		2	2										
AWRK-10/20		2	2										
AWRK-20HBK										2	2		
AWRS-20BK		2	2										
AWZK-20		2	2										
SRK-12/12D/36												2	2

RACK ITEM NUMBER

### WIRE DOUGH BOX DOLLY

Transport multiple dough boxes with ease using this wire dolly, currently the only one on the market!

- ◆ Capacity: up to 400 lbs
- ◆ Winco® exclusive
- ◆ Wheels measure 3-3/4" Dia each

ITEM	DESCRIPTION	UOM	CASE
DWR-2617	27"L x 18-1/4"W x 2-1/2"H	Each	1
DWR-CT	Caster for DWR-2617	Each	4/24
DWR-CTB	Caster w/ Brake for DWR-2617	Each	4/24

### WIRE DOLLY



Transport dough boxes

SEE PAGE 256 FOR DOUGH BOXES



DWR-2617

## FLATWARE ORGANIZERS



**NSF** FC-4H



**BPA FREE** PL-4B



SCB-4

OGZ-6



**NSF** PCB-8



## FLATWARE/CUTLERY CYLINDERS & HOLDERS

ITEM	DESCRIPTION	UOM	CASE
FC-PL	Perforated, Plastic	Each	36/144
FC-SS	Perforated, S/S	Each	20/80
FC-SL	Solid, S/S	Each	20/80
FC-4H	4-Holes/2-Tier Holder, S/S	Each	1/4
FC-6H	6-Holes/2-Tier Holder, S/S	Each	1/2

## FLATWARE/CUTLERY COMPARTMENT BINS

ITEM	DESCRIPTION	UOM	CASE
PL-4B	Plastic	Each	1/12
SCB-4	Stainless Steel	Each	1/8

## FLATWARE/CUTLERY ORGANIZERS

ITEM	DESCRIPTION	UOM	CASE
OGZ-6	Organizer Bin Set	Set	1
OGZ-1B	Single Bin for OGZ-6	Each	6

## FLATWARE/CUTLERY DISHWASHER BASKET

- ◆ Eight (8) compartments, molded-in handles
- ◆ NSF listed

ITEM	DESCRIPTION	UOM	CASE
PCB-8	17" x 8" x 6"	Each	12

## DISH CADDY



DCA-6



Includes vinyl cover

## DISH CADDY

- ◆ Rounded corner design made of polyethylene helps prevent impact damage to surrounding furnishings while caddy is in transit
- ◆ 6 adjustable divider posts allow caddy to hold trays, plates and a wide array of dish sizes
- ◆ Each column holds 45-60 plates with a diameter of 4-1/2" to 13"
- ◆ Sure-grip handle for easy and safe transporting
- ◆ Includes cover

ITEM	DESCRIPTION	UOM	CASE
<b>NSF</b> DCA-6	36-1/2"L x 58-1/2"W x 31-1/2"H	Set	1
DCA-C10	10" Caster for DCA-6	Each	1
DCA-C5B	5" Brake Caster for DCA-6	Each	1



4 columns	4-1/2" plates
2 columns	5-1/2" - 7" plates
2 columns	7" - 9" plates

4 columns 9"-13" plates

6 columns 7" - 9" plates



6 columns 5-1/2" - 7" plates

5 columns 5" plates  
2 columns 9"-13" plates

5 columns 4-1/2" plates  
3 columns 7" - 9" plates



### GRAY POLYPROPYLENE LUG BOX

- ◆ Containers can nest together, stack across each other and stack with lids on
- ◆ NSF listed

ITEM	DESCRIPTION	UOM	CASE
PL-8	24" x 15" x 8"	Each	1
PL-8C	Cover	Each	12

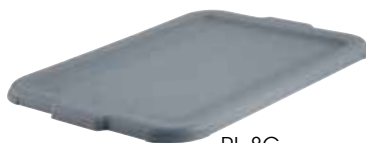

PL-8C



PL-8



Conveniently nest together

Stackable

PL-SERIES **NSF**

### HEAVYWEIGHT POLYPROPYLENE DISH BOXES

- ◆ Larger, thicker and stronger than standard dish boxes
- ◆ Freezer safe
- ◆ NSF listed

ITEM	DESCRIPTION	COLOR	UOM	CASE
PLW-7G	21" x 17" x 7"	Gray	Each	1
PLW-7K	21" x 17" x 7"	Black	Each	1
PLW-7W	21" x 17" x 7"	White	Each	1
PLW-CG	Cover	Gray	Each	12
PLW-CK	Cover	Black	Each	12
PLW-CW	Cover	White	Each	12



PLW-7W



PLW-7K



PLW-7G

PLW-SERIES **NSF**

### HEAVYWEIGHT POLYPROPYLENE PERFORATED BUS BOXES

- ◆ Drains easily to eliminate excess water
- ◆ Ideal for thawing food
- ◆ NSF listed

ITEM	DESCRIPTION	COLOR	UOM	CASE
PLP-5G	21-1/4" x 15-3/8" x 4-7/8"	Gray	Each	1
PLP-5W	21-1/4" x 15-3/8" x 4-7/8"	White	Each	1



PLP-5W



Perforated Bottom

PLP-SERIES **NSF**

### STANDARD POLYPROPYLENE DISH BOXES

- ◆ NSF listed

ITEM	DESCRIPTION	COLOR	UOM	CASE
PL-5G	20-1/4" x 15-1/2" x 5"	Gray	Each	1
PL-5K	20-1/4" x 15-1/2" x 5"	Black	Each	1
PL-5W	20-1/4" x 15-1/2" x 5"	White	Each	1
PL-7G	21-1/2" x 15" x 7"	Gray	Each	1
PL-7B	21-1/2" x 15" x 7"	Brown	Each	1
PL-7K	21-1/2" x 15" x 7"	Black	Each	1
PL-7W	21-1/2" x 15" x 7"	White	Each	1
PL-57C	Cover	Gray	Each	1/12
PL-57B	Cover	Brown	Each	1/12
PL-57K	Cover	Black	Each	1/12
PL-57W	Cover	White	Each	1/12



PL-SERIES **NSF** **BPA FREE**

### HEAVYWEIGHT POLYPROPYLENE DIVIDED BUS BOXES

- ◆ Two (2) compartments
- ◆ Economical storage for heavy loads
- ◆ Rounded corners for easy cleaning
- ◆ BPA-free

ITEM	DESCRIPTION	COLOR	UOM	CASE
PLTC-7G	21" x 16-3/4" x 6-1/2"	Gray	Each	1
PLTC-7K	21" x 16-3/4" x 6-1/2"	Black	Each	1



PLTC-7K

PLTC-SERIES **BPA FREE**

### WHITE MINI BIN

- ◆ Polypropylene
- ◆ BPA-free

ITEM	DESCRIPTION	UOM	CASE
PL-MB	14-3/4" x 12-1/2" x 5-3/8"	Each	24
PL-MBC	Cover	Each	24



PL-MB-SERIES **BPA FREE**

## FOLDING UTILITY CARTS



**NEW** UCF-2916K

UCF-2916K  
shown folded



**NEW** UCF-3820K

**ONLY  
8" WIDE  
WHEN  
FOLDED**

## FOLDING UTILITY CARTS

Folding carts add convenience of mobility and compact storage in one. Unfold to transport stacked dishes, bus boxes, or meals to serve. Handles on both ends to push or pull for mobility in either direction. Fold down to fit behind doors, between counters or in delivery van. Ideal for room service, off-site catering and table service.

- ◆ Fold and unfold in a single smooth motion
- ◆ Handles on both ends for easy mobility
- ◆ 3-tiers of easy to clean plastic shelves
- ◆ 18/8 stainless steel uprights with built-in locking latch
- ◆ 350Lb overall capacity
- ◆ Swivel casters w/4" wheels; 2 with step-lock brakes

ITEM	DESCRIPTION	UOM	CASE
UCF-2916K	29"W x 16-1/2"D x 36"H	Set	1
UCF-3820K	38-3/4"W x 20-3/4"D x 36"H	Set	1



Built-in locking latch



Easy-lift handle for transporting



UCF-2916K shown with one (1) PLW-7G



UCF-3820K shown with two (2) PLW-7G

## UTILITY & BUS CARTS



UC-2415G



UC-2415G shown with accessory bins



UC-RB

UC-SB



UC-3019K

## UTILITY CARTS

- ◆ 3-tier cart
- ◆ Polypropylene
- ◆ UC-2415 series weighs 17.5 lbs
- ◆ UC-3019 series weighs 27 lbs
- ◆ Accessory bins sold separately
- ◆ Ships knocked down

**IMPROVED**

ITEM	DESCRIPTION	CAPACITY	COLOR	UOM	CASE
UC-2415G	32"L x 16-1/8"W x 36-3/4"H	330 Lbs	Gray	Set	1
UC-2415K	32"L x 16-1/8"W x 36-3/4"H	330 Lbs	Black	Set	1
UC-3019G	40-3/4"L x 19-1/2"W x 37-3/8"H	400 Lbs	Gray	Set	1
UC-3019K	40-3/4"L x 19-1/2"W x 37-3/8"H	400 Lbs	Black	Set	1
UC-RB	Refuse Bin			Each	3
UC-SB	Silverware Bin			Each	6
UC-WH	Casters			Each	1/30

Replace former UC-35 Series, UC-40 Series, UC-B Series



## STAINLESS STEEL TROLLEYS

- ◆ 3-tier mobile cart
- ◆ Caster bumpers protect walls, doors, and the cart from minor collisions
- ◆ Ships knocked down

ITEM	DESCRIPTION (L X W X H)	UOM	CASE
SUC-30	30" x 16" x 33" (w/Casters)	Set	1
SUC-40	33" x 17" x 35" (w/Casters)	Set	1
SUC-50	37" x 19" x 37" (w/Casters)	Set	1
SUC-CT	Caster for SUC-Series	Each	4/16
SUC-CTB	Caster w/Brake for SUC-Series	Each	4/16



Caster with brake



SUC-30

### ALUMINUM END-LOAD 6-TIER BUS BOX CART

- ◆ 14 gauge aluminum with a 1" extruded aluminum tube frame
- ◆ 5" Dia x 1-1/4" W, full swivel casters
- ◆ Ships knocked down
- ◆ Capacity: 6 or more (stacked) bus or lug boxes

ITEM	DESCRIPTION	UOM	CASE
ABBC-6	18-5/8" x 26" x 70-1/4", Fits PL-5G, PL-5K, PL-5W, PL-7G, PL-7K, PL-7W Winco® Bus Boxes	Set	1
ALRC-5ST	Caster for ABBC-6	Each	12

### ALUMINUM LUG BOX CART

- ◆ 14 gauge aluminum with a 1" extruded tube frame
- ◆ 5" Dia x 1-1/4" W, full swivel casters
- ◆ Ships knocked down
- ◆ Use with single or stacked lug boxes

ITEM	DESCRIPTION	UOM	CASE
ALBC-1	16-3/4" x 25-1/16" x 19", Fits PL-5, PL-7, PL-8 Winco® Lug Boxes	Set	1
ALRC-5ST	Caster for ALBC-1	Each	12

## LUG BOX/BUS BOX CARTS



ABBC-6 NSF



ALBC-1 NSF

### DELIVERY BAGS

- ◆ Outer shell/liner: polyester, Filling: EPE
- ◆ Heat retention: 2 hours @ 167°F; 4 hours @ 131°F; 6 hours @ 95°F

ITEM	DESCRIPTION	UOM	CASE
BGDV-12	12" x 12" x 12"	Each	6
BGDV-22	22" x 22" x 13"	Each	6

### PIZZA BAGS

- ◆ Outer shell/liner: polyester, Filling: EPE
- ◆ Insulated lining to keep food warm for longer periods of time

ITEM	DESCRIPTION	UOM	CASE
BGPZ-18	18" x 18" x 5"	Each	6
BGPZ-20	20" x 20" x 5"	Each	6
BGPZ-24	24" x 24" x 5"	Each	6

## PIZZA/DELIVERY BAGS



BGDV-12

BGPZ-20

### DURABLE POLYPROPYLENE DRY INGREDIENT BINS

- ◆ Ideal mobile storage for dry bulk ingredients
- ◆ Space-efficient under-counter height
- ◆ Advanced super-clasp slanted lid design easily slides open to scoop ingredients; when closing, lid slides over the bin to reduce possible debris on the lid from falling in
- ◆ Quickly view contents through the clear cover to identify ingredients and manage inventory
- ◆ Four 3" casters (2 fixed & 2 swivel w/brakes) for easy mobility
- ◆ Built-in storage holds the included scoop, effectively keeping the handle out of ingredients
- ◆ NSF listed

ITEM	DESCRIPTION	SIZE	UOM	CASE
IB-21	21 Gallon	13" x 29-1/4" x 28"	Set	1
IB-27	27 Gallon	15-1/2" x 29-1/2" x 28"	Set	1
IB-C3	Fixed Caster	3" Dia, Fits IB-21 and IB-27	Each	1
IB-C3B	Swivel Caster w/Brake	3" Dia, Fits IB-21 and IB-27	Each	1
IB-21-LE	Lid	Fits IB-21	Each	6
IB-27-LE	Lid	Fits IB-27	Each	6

## DRY BULK INGREDIENT BINS



Built-in storage holds scoop



IB-C3



IB-C3B



IB-21

MODEL	WEIGHT SUGAR	WEIGHT FLOUR
IB-21	159 lbs	124 lbs
IB-27	197 lbs	154 lbs

IB-SERIES NSF

## INSULATED ICE CADDY



NSF IIC-SERIES

IIC-29

### INSULATED ICE CADDY

- ◆ Can be used inside or outdoors, in hot or humid conditions
- ◆ Drain shelf keeps ice separate from the water, greatly increasing storage time
- ◆ Polyethylene molded body is durable and light-weight, top lid slides open
- ◆ Polyurethane foam insulation effectively keeps ice cold for several days
- ◆ Recessed front handle for convenient pulling or lifting
- ◆ No assembly required; oil caster wheel bearings before use
- ◆ 125 lb capacity
- ◆ NSF listed

ITEM	DESCRIPTION	SIZE	UOM	CASE
IIC-29	Ice Caddy w/Sliding Lid	Ext Dim: 23" x 31.5" x 29.25"	Set	1
IIC-C8	Caster for IIC-29	8"	Each	1
IIC-C5B	Brake Caster for IIC-29	5"	Each	1

## HOT / COLD FOOD TRANSPORTERS



IFT-1



IFT-2  
Built-in dolly with casters



IFT-1 & IFT-1D



INTERIOR VIEW IFT-1



IFT-1D (INCLUDES STRAP)  
Can also be used with IFPC-series

### FULL-SIZE HOT/COLD FOOD TRANSPORTERS

- ◆ Molded with polypropylene and insulated with polyurethane foam to maintain safe food serving temperatures for hours without the use of electricity or sterno
- ◆ Adjustable vent cap equalizes outside and inside compartment pressure for easy lid opening
- ◆ Stackable and interlockable for easy storage, and space saving
- ◆ Standard food service pans are easy to load and remove
- ◆ Easy-to-clean holding compartments
- ◆ NSF listed

ITEM	DESCRIPTION	UOM	CASE
IFT-1	Single Cabinet Insulated Food Pan Transporter	Set	1
IFT-2	Double Cabinet Insulated Food Pan Transporter w/Built-In Dolly	Set	1
IFT-1D	Dolly w/Casters & Cargo Strap fits IFT-1	Set	1
IFT-C5	5" Caster for IFT-2 & IFT-1D	Each	1
IFT-C5B	5" Brake Caster for IFT-2 & IFT-1D	Each	1

ITEM	DIMENSIONS	COMPARTMENT CAPACITY	
IFT-1	Exterior Dimensions: 18-3/4"W x 26-3/4"D x 24-1/2"H Interior Dimensions: 13-1/4"W x 21"D x 19-5/16"H	6 Full-Size, 2.5" H 4 Full-Size, 4" H 3 Full-Size, 6" H 4 Half-Size, 6" H	8 Half-Size, 4" H 9 1/3 Size, 6" H 12 1/3 Size, 4" H 6 1/3 Size, 8" H
IFT-2	Exterior Dimensions: 20"W x 27-1/2"D x 47-1/4"H Interior Dimensions for Each Compartment: 13-1/4"W x 21"D x 17"H	Each of the two compartments: 4 Full-Size, 2-1/2" H 3 Full-Size, 4" H 2 Full-Size, 6" H 10 Half-Size, 2-1/2" H	Can hold the following pans: 6 Half-Size, 4" H 4 Half-Size 6" H 6 1/3rd Size, 6" H 9 1/3rd Size, 4" H
IFT-1D		Use with IFT-1	

HOT					
IFT	188°F	184°F	179°F	175.5°F	171.5°F
IFPC	188°F	184.5°F	181.5°F	179°F	176°F
Starting Temperature	1 hour	2 hours	3 hours	4 hours	
COLD					
IFT	33.8°F	34.6°F	35.4°F	36.3°F	37.1°F
IFPC	32°F	33°F	34°F	35.5°F	36.5°F
Starting Temperature	1 hour	2 hours	3 hours	4 hours	

NSF IFT-SERIES



# EQUIPMENT

*Prep, Cook, Hold  
& Merchandise*



COMMERCIAL MANUAL CAN OPENERS

PREMIUM MANUAL CAN OPENERS

Our premium European-made heavy-duty nickel-plated can opener is fitted with a removable clamp, it is ideal for on-the-go operations that require flexibility. The rust-resistant stainless steel blade and gear effectively opens various can sizes up to #10.

NEW



CO-3N with blade removed



Securely clamps to work surface



CO-3N in use

- ◆ Includes base, blade, gear and installation kit for mounting on wooden or stainless steel work tables
- ◆ Easily disassembles for cleaning/sanitizing
- ◆ Heavy-duty nickel-plated steel construction
- ◆ Rigid universal mounting base for screw-down or clamp-on installation with wooden or stainless steel work tables
- ◆ 19" (482mm) long bar accommodates various sizes of cans up to 16" (406mm) tall
- ◆ Quick change dual-sided tempered knife blade and stainless steel gear
- ◆ NSF listed
- ◆ One year parts and labor warranty

ITEM	DESCRIPTION	UOM	CASE
CO-3N	Nickel Plated, Steel Base, NSF*	Each	1/12
CO-3N-B	1-Pc S/S Replacement Blade for CO-3N	Each	1
CO-3G	1-Pc S/S Replacement Gear Set for CO-3N	Each	1

\*Replaces CO-3



CO-3N-B



CO-3G



CO-3N portable clamp



NSF CO-3N

STAINLESS STEEL BLADE & GEAR PORTABLE CLAMP INCLUDED

STANDARD #1 MANUAL CAN OPENER

The go-to industry standard, steel body can opener, made for heavy usage kitchen environments that require processing of up to 50 cans a day. Opens various can sizes up to #10.

- ◆ Includes base, blade, gear and installation kit
- ◆ Rigid universal mounting base for screw-down to a wooden or stainless steel work tables
- ◆ 13" (330mm) long bar accommodates any size can up to 10" (254mm) tall
- ◆ Extra-durable dual-sided knife blade and gears are interchangeable with most other can opener brands
- ◆ One year parts and labor warranty



CO-1



Securely clamps to work surface

ITEM	DESCRIPTION	UOM	CASE
CO-1	Cast Iron Body	Set	1
CO-1B	2-Pc Replacement Blade Set for CO-1	Set	24/288
CO-1G	1-Pc Replacement Gear Set for CO-1	Each	12/144



CO-1B



CO-1G

**QUICK-SLICE FRUIT & VEGETABLE SLICER**

Save on time and labor with the Kattex Fruit & Vegetable Slicer by simply putting produce in the holder to turn out uniform slices in seconds.

- ◆ Aluminum construction with 9-1/4" stainless steel adjustable blade
- ◆ Easy to use calibrated 1/16" (1mm) to 1/2"(12mm) slice thickness gauge
- ◆ Mounts to countertops and other flat surfaces, can easily be removed for storage and cleaning
- ◆ Can accommodate fruits and vegetables with a maximum of 4" diameter and 5-1/2" in length
- ◆ One year parts and labor warranty

MODEL	OVERALL DIMENSIONS			SHIP WEIGHT
	LENGTH	DEPTH	HEIGHT	
FVS-1	16" (406mm)	8-11/16" (220mm)	16" (406mm)	12.13 lbs (5.5 kgs)



ITEM	DESCRIPTION	UOM	CASE
FVS-1	21"L x 10-3/4"W x 16"H	Each	1/2
FVS-1B	2-Pc Replacement Blades	Set	1/10
FVS-1SB	Replacement Shaft and Blade Turntable Assembly	Each	1/6

**KATTEX™**  
**FRUIT & VEGETABLE SLICER**



FVS-1



Thickness gauge



Replacement blade



**CUTTING BOARD MOUNT FOR FRUIT & VEGETABLE SLICER**

Add portability to the KATTEX Fruit and Vegetable Slicer (FVS-1) with this customized STATIKBOARD™ cutting board mount. The molded-through, non-slip feet prevent slipping & sliding, even on wet countertops, and the fully-rubberized hook provides easy storage.

- ◆ Board size: 12" (30.5mm) x 18" (45.7mm) x 1/2" (1.3mm)
- ◆ Built-in hook for easy transport and hygienic storage
- ◆ Dishwasher safe tough durable copolymer board construction
- ◆ Stainless steel flush mounting hardware included (mounting bracket sold separately or comes with FVS-1)
- ◆ NSF listed



ITEM	DESCRIPTION	UOM	CASE
CBM-1218	Cutting Board Mount for FVS-1	Each	1

**STATIKboard™**

PATENTED ORIGINAL DESIGN



CBM-1218 NSF



FVS-1 on CBM-1218



# KATTEX™ TOMATO SLICERS

INCLUDES  
BLADE  
REPLACEMENT  
WRENCH



TTS-188



TTS-188-B

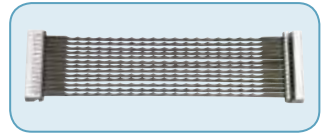

TTS-188S-B

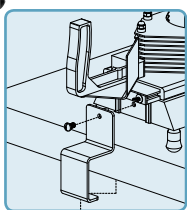

Stop/hold bracket included



KAT-WR

NSF TTS-SERIES

## PRECISE-SLICE TOMATO SLICERS

Razor sharp stainless steel blades smoothly and swiftly produce uniform slices without squeezing or crushing

- ◆ Durable cast aluminum construction
- ◆ Aluminum frame with stainless steel replaceable blades
- ◆ Ergonomic vertical handle for effortless slicing
- ◆ Cuts 2 dozen tomatoes into 3/16" or 1/4" thick slices in only 1 minute
- ◆ HDPE board ensures safe & durable food processing
- ◆ Rubber non-slip feet to ensure maximum stability
- ◆ Slicers come standard with table stop bracket
- ◆ NSF listed
- ◆ One year parts and labor warranty

MODEL	OVERALL DIMENSIONS			SHIP WEIGHT
	LENGTH	DEPTH	HEIGHT	
TTS-188	16-1/2" (420mm)	8-1/4" (210mm)	9-1/2" (240mm)	9.27 lbs (4.2 kgs)
TTS-188S				
TTS-250				
TTS-250S				

ITEM	DESCRIPTION	UOM	CASE
TTS-188	3/16" Cut w/Straight Blade	Set	1/4
TTS-188S	3/16" Cut w/Serrated Blade	Set	1/4
TTS-250	1/4" Cut w/Straight Blade	Set	1/4
TTS-250S	1/4" Cut w/Serrated Blade	Set	1/4

### TOMATO SLICER ACCESSORIES

ITEM	DESCRIPTION	UOM	CASE
TTS-188-B	3/16" Straight Blade Assembly for TTS-188	Set	1/12
TTS-188S-B	3/16" Serrated Blade Assembly for TTS-188	Set	1/12
TTS-250-B	1/4" Straight Blade Assembly for TTS-250	Set	1/12
TTS-250S-B	1/4" Serrated Blade Assembly for TTS-250	Set	1/12
KAT-FE	4-Pc Replacement Feet Set	Set	1
KAT-WR	Dual-End Wrench	Each	1/25

# KATTEX™ ONION SLICERS

INCLUDES  
LEG MOUNTING  
WRENCH



OS-250



KAT-WR



OS-250B  
Blade set assembly

NSF OS-SERIES

## QUICK-SLICE ONION/FRUIT/VEGETABLE SLICERS

Just one smooth stroke of the Kattex Onion/Fruit/Vegetable Slicer will produce evenly sliced coins of fruits and vegetables, perfect on salads, in cocktails and more.

- ◆ Aluminum construction with stainless steel blades
- ◆ Unique lever-handle allows for quick and easy operation
- ◆ Sturdy base with non-skid feet
- ◆ Two blades included can be stacked to create a finer cut
- ◆ 4-1/2" x 3-3/4" cutting area
- ◆ NSF listed
- ◆ One year parts and labor warranty

MODEL	OVERALL DIMENSIONS			SHIP WEIGHT
	LENGTH	DEPTH	HEIGHT	
OS-188	19" (483mm)	10" (254mm)	19" (483mm)	17.79 lbs (8.06 kgs)
OS-250				

ITEM	DESCRIPTION	UOM	CASE
OS-188	3/16" Cut	Each	1/2
OS-250	1/4" Cut	Each	1/2

### ONION/FRUIT/VEGETABLE SLICER ACCESSORIES

ITEM	DESCRIPTION	UOM	CASE
OS-188B	3/16" Blade Set Assembly for OS-series, 2-Ps/Set	Set	1/10
OS-250B	1/4" Blade Set Assembly for OS-series, 2-Pcs/Set	Set	1/10
KAT-FE	4-Pc Replacement Feet Set	Set	1
KAT-BS-OT	4-Pc Replacement Bushings	Set	1
KAT-WR	Dual-End Wrench	Each	1/25



**QUICK-SLICE LETTUCE CUTTER**

Cut multiple heads of crisp, fresh lettuce in seconds. The interlocking scalloped, pretensioned blades are sized to cut 1 inch squares of cored lettuce, without bruising or browning.

- ◆ Aluminum frame with easy-grip handle
- ◆ Stainless steel blade with 49 square cuts
- ◆ Cuts lettuce into 1" x 1" slices in less than 1 minute
- ◆ Field convertible into 1" x 2" cuts for Romaine lettuce
- ◆ Rubber feet prevent slipping/scratching on work surface
- ◆ 7" x 7" cutting area
- ◆ NSF listed
- ◆ One year parts and labor warranty

MODEL	OVERALL DIMENSIONS			SHIP WEIGHT
	LENGTH	DEPTH	HEIGHT	
TLC-1	13" (330mm)	18" (457mm)	20" (508mm)	17.79 lbs (8.06 kgs)

ITEM	DESCRIPTION	UOM	CASE
TLC-1	1" x 1" Cut	Each	1/2

**LETTUCE CUTTER ACCESSORIES**

ITEM	DESCRIPTION	UOM	CASE
TLC-1-B	Replacement Blade for TLC-1	Each	1/10
KAT-FT	4-Pc Replacement Feet Set	Set	1
KAT-BS-OT	4-Pc Replacement Bushings	Set	1
KAT-WR	Dual-End Wrench	Each	1/25

**KATTEX™  
LETTUCE CUTTER**

INCLUDES  
LEG MOUNTING  
WRENCH



TLC-1



KAT-WR

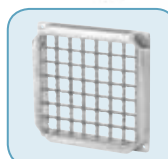

TLC-1-B

TLC-SERIES



**QUICK-SLICE CHEESE SLICERS**

Make light work of slicing a variety of semi-soft cheeses, with uniform, consistent results. Ideal for portion control and faster food prep.

- ◆ Cast aluminum construction with stainless steel wires
- ◆ Cutting area accommodates 1/3 of a 5 lb cheese block
- ◆ Cut 3/8" or 3/4" cheese sticks, cubes or slices
- ◆ Cleaning brush included
- ◆ NSF listed
- ◆ One year parts and labor warranty

MODEL	OVERALL DIMENSIONS			SHIP WEIGHT
	LENGTH	DEPTH	HEIGHT	
TCT-375	13-1/4" (335mm)	6-3/4" (170mm)	4-1/2" (115mm)	4.21 lbs (1.91 kgs)
TCT-750				

ITEM	DESCRIPTION	UOM	CASE
TCT-375	3/8" Cut	Each	1/4
TCT-750	3/4" Cut	Each	1/4

**CHEESE SLICER ACCESSORIES**

ITEM	DESCRIPTION	UOM	CASE
TCT-375B	Replacement Bow for TCT-375	Set	1/10
TCT-750B	Replacement Bow for TCT-750	Set	1/10

**KATTEX™  
CHEESE SLICERS**



TCT-375

TCT-750



TCT-375B  
3/8" wide cuts

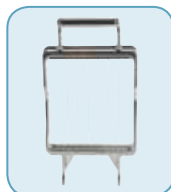

TCT-750B  
3/4" wide cuts



Uniformly slice  
cheese blocks

TCT-SERIES



# KATTEX™ CHOPPERS/DICERS



HCD-250

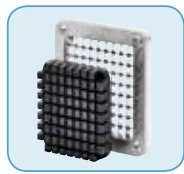

Replacement blade and block

**NSF** HCD-SERIES

## QUICK-SLICE CHOPPERS/DICERS

The Kattex Chopper/Dicer produces perfectly diced onions, tomatoes and cucumbers too.

- ◆ Cast aluminum construction with stainless steel blades
- ◆ Sturdy base with non-skid feet
- ◆ 3-3/8" x 3-3/8" cutting area
- ◆ NSF listed
- ◆ One year parts and labor warranty

MODEL	OVERALL DIMENSIONS			SHIP WEIGHT
	LENGTH	DEPTH	HEIGHT	
HCD-250	7-15/16" (200mm)	7-15/16" (200mm)	18-1/2" (470mm)	7.05 lbs (3.2 kgs)
HCD-375				
HCD-500				

ITEM	DESCRIPTION	UOM	CASE
HCD-250	1/4" Cut	Each	1/4
HCD-375	3/8" Cut	Each	1/4
HCD-500	1/2" Cut	Each	1/4

## CHOPPER/DICER ACCESSORIES

ITEM	DESCRIPTION	UOM	CASE
HCD-250BK	1/4" Replacement Blade & Block for HCD-series	Set	1/10
HCD-375BK	3/8" Replacement Blade & Block for HCD-series	Set	1/10
HCD-500BK	1/2" Replacement Blade & Block for HCD-series	Set	1/10
HCD-BR	2-Pc Black Rubber Ring	Set	1/50
KAT-FT	4-Pc Replacement Feet Set	Set	1
KAT-BS-FH	4-Pc Replacement Bushings	Set	1

# KATTEX™ FRUIT WEDGE SLICERS



FWS-8



FWS-6BC  
Apple corer blade



FWS-6BK  
Replacement wedger and blade for citrus fruits

**NSF** FWS-SERIES

## QUICK-SLICE FRUIT WEDGE SLICERS

Get quick and uniform wedges of fruit with a push of the handle. Ideal for coring and sectioning apples, lemons, limes, oranges, and tomatoes.

- ◆ Aluminum construction with sharp stainless steel blades that minimize squeezing and bruising
- ◆ Sturdy base with non-skid feet
- ◆ 3-1/2" diameter cutting area
- ◆ NSF listed
- ◆ One year parts and labor warranty

MODEL	OVERALL DIMENSIONS			SHIP WEIGHT
	LENGTH	DEPTH	HEIGHT	
FWS-6	7-15/16" (200mm)	7-15/16" (200mm)	18-1/2" (470mm)	5.74 lbs (2.6 kgs)
FWS-8				

ITEM	DESCRIPTION	UOM	CASE
FWS-6	6-Wedge	Each	1/4
FWS-8	8-Wedge	Each	1/4

## FRUIT WEDGE SLICER ACCESSORIES

ITEM	DESCRIPTION	UOM	CASE
FWS-6BK	6-Section Wedger & Blade Replacement for FWS-series	Set	1/10
FWS-8BK	8-Section Wedger & Blade Replacement for FWS-series	Set	1/10
FWS-6BC	6-Slice Apple Corer for FWS-Series	Each	10
FWS-8BC	8-Slice Apple Corer for FWS-Series	Each	10
KAT-FT	4-Pc Replacement Feet Set	Set	1
KAT-BS-FH	4-Pc Replacement Bushings	Set	1



## QUICK-SLICE FRENCH FRY CUTTERS - HEAVY-DUTY

The Kattex Quick Slice French Fry Cutter improves food prep efficiency by quickly slicing potatoes, fruits & vegetables. The durable cast iron body construction with stainless steel components ensures the cutter will withstand years of high-volume and heavy-duty use.

- ◆ Short throw handle design for smooth and uniform cuts in one stroke
- ◆ Extremely durable cast iron body with stainless steel components
- ◆ Affix to counter or wall mount; wall bracket sold separately
- ◆ Accessories to modify cut sizes and styles sold separately
- ◆ 3-3/8" x 3-3/8" cutting area
- ◆ NSF listed
- ◆ One year parts and labor warranty

MODEL	OVERALL DIMENSIONS			SHIP WEIGHT
	LENGTH	DEPTH	HEIGHT	
HFC-250	8" (203mm)	14" (355mm)	16-3/4" (425mm)	12.68 lbs (5.75 kgs)
HFC-375				13.6 lbs (6.17 kgs)
HFC-500				13.23 lbs (6 kgs)

ITEM	DESCRIPTION	UOM	CASE
HFC-250	1/4" Cut	Set	1
HFC-375	3/8" Cut	Set	1
HFC-500	1/2" Cut	Set	1

### FRENCH FRY CUTTER ACCESSORIES

ITEM	DESCRIPTION	UOM	CASE
HFC-250R	1/4" Cut Replacement Blade	Set	1/48
HFC-375R	3/8" Cut Replacement Blade	Set	1/48
HFC-500R	1/2" Cut Replacement Blade	Set	1/48
HFC-250B	1/4" Cut Blade Assembly	Set	1/24
HFC-375B	3/8" Cut Blade Assembly	Set	1/24
HFC-500B	1/2" Cut Blade Assembly	Set	1/24
HFC-250K	Pusher Block for 1/4" and 1/2" Cut Blade	Each	1/24
HFC-375K	Pusher Block for 3/8" Cut Blade	Each	1/24
HFC-BK	Wall Bracket for HFC series	Each	1/12

# KATTEX™

## FRENCH FRY CUTTERS - HEAVY-DUTY



HFC-375



Wall mounted with HFC-BK

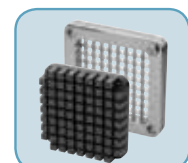

Replacement block and cut blade assembly

HFC-SERIES

### FRENCH FRY CUTTERS - MEDIUM-DUTY

- ◆ Made of heavy-duty cast iron and fitted with sharp stainless steel blades for even slicing
- ◆ Ergonomic handles makes for easy operating and sturdy legs provide stability on flat countertop surfaces

MODEL	OVERALL DIMENSIONS			SHIP WEIGHT
	LENGTH	DEPTH	HEIGHT	
FFC-250	8" (203mm)	14" (355mm)	16-3/4" (425mm)	11.55 lbs (5.24 kg)
FFC-375				
FFC-500				

ITEM	DESCRIPTION	UOM	CASE
FFC-250	1/4" Cut	Each	1
FFC-375	3/8" Cut	Each	1
FFC-500	1/2" Cut	Each	1

### MEDIUM-DUTY FRENCH FRY CUTTER ACCESSORIES

ITEM	DESCRIPTION	UOM	CASE
FFC-250B	Blade Assembly for FFC-250	Each	24
FFC-250K	Pusher Block for FFC-250	Each	24
FFC-375B	Blade Assembly for FFC-375	Each	24
FFC-375K	Pusher Block for FFC-375	Each	24
FFC-500B	Blade Assembly for FFC-500	Each	24
FFC-500K	Pusher Block for FFC-500	Each	24
FFC-500P	Pusher Support for FFC-Series	Each	12

### FRENCH FRY CUTTERS - MEDIUM-DUTY



FFC-375



FFC-250B

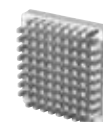

FFC-250K



FFC-500P



CONCESSION EQUIPMENT



CCM-28C  
Dome Cover



CCM28-P10



ELECTRIC COTTON CANDY MACHINES

The ShowTime!™ cotton candy machines are sure to impress whether at a carnival, candy shop, or catering event. Entice customers with the sweet scent and cones of the fluffy treat. The machine is available as a counter-top unit or with cart for convenient mobility.

- ◆ Simple, easy-to-use controls; makes 120 cones per hour
- ◆ Includes sugar scooper for pouring floss sugar
- ◆ 20-1/2" diameter stainless steel bowl securely clips on and locks to base
- ◆ Large capacity built-in stainless steel supply drawer
- ◆ Spinner head holds 4oz of sugar and releases floss vertically to prevent clogging
- ◆ Low vibration 1.5hp heavy-duty motor with belt drive and two (2) replacement belts
- ◆ Easy access to voltage meter and fuse for use on generators and power supplies
- ◆ One year parts and labor warranty

ELECTRIC COTTON CANDY MACHINE

OVERALL DIMENSIONS			POWER	PLUG	SHIP WEIGHT
WIDTH	DEPTH	HEIGHT			
20-1/2" (520mm)	20-1/2" (520mm)	18-15/16" (480mm)	110V-60Hz, 1080W, 9A	NEMA 5-15P	33 lbs (15 kgs)

ITEM	DESCRIPTION	UOM	CASE
CCM-28	Cotton Candy Machine	Set	1

ELECTRIC COTTON CANDY MACHINE WITH CART

- ◆ Overall dimensions: 37-3/4"L x 20-1/2"W x 34-1/2"H
- ◆ High polished push handle and spoked wheels
- ◆ 13" inflatable rubber tires for easy transport
- ◆ Two (2) side shelves for merchandising product (each shelf measures 11" x 12-5/8"); one side with handle and other with slots to hold cones

OVERALL DIMENSIONS			POWER	PLUG	SHIP WEIGHT
WIDTH	DEPTH	HEIGHT			
37-3/4" (959mm)	20-1/2" (520mm)	34-1/2" (876mm)	110V-60Hz, 1080W, 9A	NEMA 5-15P	49.6 lbs (22.5 kgs)

ITEM	DESCRIPTION	UOM	CASE
CCM-28M	Cotton Candy Machine with Cart	Set	1

COTTON CANDY MACHINE ACCESSORIES

- ◆ Optional clear cover (sold separately) provides protection from wind and debris
- ◆ Cover only: 21"L x 21"W x 14"H
- ◆ Optional floss stabilizer (sold separately) helps to catch floss on the mesh surface

ITEM	DESCRIPTION	UOM	CASE
CCM-28C	Clear Plastic Dome Cover	Each	1/5
CCM28-P3	Replacement Belt	Each	1
CCM28-P5	Sugar Spoon	Each	1
CCM28-P10	Floss Stabilizer	Each	1

**ELECTRIC POPCORN POPPERS**

The ShowTime!™ popcorn poppers are sure to impress whether at a carnival, stadium, or catering event. Attract customers with the colorful graphics and entice them with the warm buttery scent.

- ◆ Removable 8 oz stainless steel kettle (8R non-stick) with twist locking disconnect
- ◆ Independent illuminated control switches for Light, Heat, Turn (motor), POP-8B has additional switch for Power
- ◆ Front & side tempered glass panels
- ◆ Rear clear plexiglass door(s)
- ◆ Mirror polished stainless steel fold-out tray for easy access
- ◆ Built in warmer light
- ◆ Under-deck warming element
- ◆ Removable crumb tray
- ◆ One year parts and labor warranty



ETL Intertek POP-8B

ITEM	OVERALL DIMENSIONS			POWER	PLUG	SHIP WEIGHT
	LENGTH	DEPTH	HEIGHT			
POP-8B	17-3/4" (450mm)	14-3/4" (375mm)	23-1/2" (597mm)	110V~60Hz, 1150W, 9.5A	NEMA 5-15P	40.8 lbs (18.5 kgs)
POP-8R	22" (559mm)	16-1/2" (420mm)	30" (762mm)	110V~60Hz, 1320W, 12A		55.12 lbs (25 kgs)

ITEM	DESCRIPTION	UOM	CASE
POP-8B	Black Popcorn Popper	Set	1
POP-8R	Red Popcorn Popper, Teflon® Coated Non-Stick Kettle	Set	1
POP8-P1	Replacement Non-stick Pot for POP-8R	Each	1
POP8-P2	Replacement Pot for POP-8B	Each	1

**CART FOR POPCORN POPPER**

- ◆ Allows the (POP-8R) Popcorn Machine to be portable
- ◆ Ideal where counterspace is limited
- ◆ Spoked 23-1/2" inflatable rubber tires and sturdy handle for easy transport
- ◆ Convenient compartment on operator-side for storage and additional work space
- ◆ Overall Dimensions: 36-7/8"L x 22-3/4"D x 34-5/8"H



ETL Intertek POP-8R

ITEM	DESCRIPTION	UOM	CASE
POP-8RC	Cart for POP-8R	Set	1
POP-8RC-D	"POPCORN" Decal	Each	1



Storage compartment



POP-8RC-D  
Traditional-style decal option



Cart includes fun decal to coordinate with POP-8R  
POP-8RC

**winco**  
**SPECTRUM™**  
 HOT DOG ROLLER GRILLS  
 & SNEEZE GUARDS

**NEW**



**NEW**

EHDG-5R



**NEW**

EHDG-11R



**NEW**

EHDG-7R & EHDG-7SG



EHDG-R-SERIES



SEE PAGE 108  
 FOR CONDIMENT  
 DISPENSER AND  
 SQUEEZE BOTTLES



**NEW**

EHDG-5SG

**ROLLSRIGHT™ COUNTERTOP HOT DOG ROLLER GRILLS**

A great addition to any quick service establishment. Dual temperature controls allow for both cooking and holding areas to operate independently, reducing waste and spoilage due to excessive overheating. The RollRight™ non-stick roller surfaces stand up to continual use and are easy to clean. This versatile machine is also great for egg rolls, taquitos, sausages, and more!

- ◆ Easy-to-clean non-stick rollers; sealed ends protect internal parts
- ◆ Heavy-duty sealed motor
- ◆ Bike chain and sprocket drive assembly
- ◆ Two independent thermostatic heat controls (front & rear)
- ◆ Individual heating element in each roller for end to end temperature consistency
- ◆ Heavy duty stainless steel body and drip pan
- ◆ Re-settable fuse for safety
- ◆ Non-skid rubber feet.
- ◆ Cooking surface holds up to 12 hot dogs (-5R), 18 hot dogs (-7R) and 30 hot dogs (-11R)
- ◆ One year parts and labor warranty

ITEM	OVERALL DIMENSIONS			POWER	PLUG	SHIP WEIGHT
	LENGTH	DEPTH	HEIGHT			
EHDG-5R	23" (585mm)	10-1/2" (270mm)	7" (180mm)	110V-60Hz, 700W, 6.3A	NEMA 5-15P	17.2 lbs (7.8 kgs)
EHDG-7R	23" (585mm)	13-1/2" (345mm)	7" (180mm)	110V-60Hz, 900W, 8.1A		20.9 lbs (9.5 kgs)
EHDG-11R	23" (585mm)	19-3/4" (505mm)	7" (180mm)	110V-60Hz, 1400W, 12.7A		29.7 lbs (13.5 kgs)

ITEM	DESCRIPTION	UOM	CASE
EHDG-5R	Hot Dog Roller, 5 Rollers	Set	1
EHDG-7R	Hot Dog Roller, 7 Rollers	Set	1
EHDG-11R	Hot Dog Roller, 11 Rollers	Set	1
EHDG-P10	Replacement Knob for EHDG-Series	Each	1

**SNEEZE GUARDS FOR HOT DOG ROLLER GRILLS**

- ◆ Increase sanitation and protect food from airborne contaminants with customer-facing sneeze guards
- ◆ Durable, curved tempered glass allows customers a direct view of available food options

ITEM	DESCRIPTION	UOM	CASE
EHDG-5SG	Fits EHDG-5R	Each	1
EHDG-7SG	Fits EHDG-7R	Each	1
EHDG-11SG	Fits EHDG-11R	Each	1



**NEW**

EHDG-11R & EHDG-11SG

High-performance motor with impact-resistant stainless steel blades adds power and performance to your busy establishment.

## ACCELMIX™ BLENDERS

### 68 OZ (2 L) LARGE CAPACITY COMMERCIAL BLENDER

- ◆ 68 oz (2 L), break-resistant and BPA-free Tritan™ container
- ◆ High-performance 2 hp motor; unique high-impact blades
- ◆ Metal-to-metal coupling; easy to operate "PULSE" and
- ◆ "ON /OFF" paddle controls & variable speed control dial
- ◆ Container/pitcher is heat-resistant up to 226°F (108°C); reduce pressure by removing cap in the lid
- ◆ Removable container cover and cap for adding/blending ingredients mid-cycle
- ◆ 11-1/2" tamper included - fits through lid opening and reaches full length of container to blend/stir while mixing
- ◆ All parts (except bases & blade fixing block) are dishwasher safe
- ◆ One year parts and labor warranty

OVERALL DIMENSIONS			POWER	PLUG	SHIP WEIGHT
WIDTH	DEPTH	HEIGHT			
8-11/16" (220mm)	9-13/16" (249mm)	19-5/16" (490mm)	120V~60Hz, 1450W, 12.1A	NEMA 5-15P	10.36 lbs (4.7 kgs)
CONTAINER DIMENSIONS					
WIDTH	DEPTH	HEIGHT			
6-11/16" (178mm)	6-11/16" (178mm)	12-3/8" (314mm)			

ITEM	DESCRIPTION	UOM	CASE
XLB-1000	Accelmix™ 68 Oz Blender	Set	1/4
XLB1000P1	Rod Set	Each	1
XLB1000P2	Pitcher Assembly	Each	1
XLB1000P4	Refilling Cap	Each	1
XLB1000P5	Blade Assembly	Each	1
XLB1000P10	Mushroom Head Fitting	Each	1
XLB1000P11	68 oz Pitcher	Each	1
XLB1000P19	Blade Removal Tool	Each	1



ACCELMIX™

by Winco®



Blend fruits, ice and a variety of other ingredients

XLB-1000 NOW INCLUDES BLADE REMOVAL TOOL



XLB1000P19



XLB-1000

TRITAN™ CONTAINER

### 44 OZ (1.25 L) 2-SPEED QUIET BAR BLENDER

- ◆ 44 oz (1.25 L), break-resistant and BPA-free Tritan™ container
- ◆ Quiet, high-performance 1/2 hp self-lubricating motor; uniquely designed high-impact blades
- ◆ HIGH/LOW toggle switch for precise consistency control
- ◆ Blade is removable for easy cleaning
- ◆ Non-skid feet securely grip the surface for stable operation
- ◆ Removable container cover and cap for adding/blending ingredients mid-cycle
- ◆ One year parts and labor warranty

OVERALL DIMENSIONS			POWER	PLUG	SHIP WEIGHT
WIDTH	DEPTH	HEIGHT			
7" (178mm)	7-7/16" (189mm)	15-7/16" (392mm)	120V~60Hz, 400W, 3.5A	NEMA 5-15P	5.51 lbs (2.5 kgs)
CONTAINER DIMENSIONS					
WIDTH	DEPTH	HEIGHT			
7" (178mm)	5-1/8" (130mm)	9-1/4" (235mm)			

ITEM	DESCRIPTION	UOM	CASE
XLB-44	Accelmix 44 Oz Blender	Set	1/4
XLB44-P1	Filler Cap	Each	1
XLB44-P2	Container Lid	Each	1
XLB44-P3	44 oz Pitcher	Each	1
XLB44-P4	Gasket	Each	1
XLB44-P5	Blade Assembly	Each	1
XLB44-P6	Collar	Each	1
XLB44-P7	Clutch	Each	1
XLB44-P10	Pitcher Assembly	Each	1



ADD POWER & PERFORMANCE!

XLB-44

TRITAN™ CONTAINER



# REFRIGERATED COLD BEVERAGE DISPLAY



Comfortably fits 100 cans

**USES ENVIRONMENTALLY FRIENDLY R290 REFRIGERANT**

## COUNTERTOP REFRIGERATED BEVERAGE DISPLAYS

With its clear panels and 4 LED light strips, this countertop display can keep up to 100 standard 12 oz cans chilled. These units use R290 refrigerant making them an environmentally-responsible choice.

- ◆ Digital temperature display from 32°F to 42°F (0°C - 6°C)
- ◆ R-290 environmentally safe refrigerant
- ◆ 360° view of refrigerated product
- ◆ 2 double, curved-glass doors for dual access and easy placement of inner contents
- ◆ 4 LED strips for effective product lighting
- ◆ Comfortably fits up to 100 cans (standard 12 oz) with 25 cans per shelf
- ◆ 4-level merchandising display; three (3) shelves are adjustable to fit multiple product heights
- ◆ Automatic defrost and ventilated cooling system
  
- ◆ One year parts and labor warranty

OVERALL DIMENSIONS			POWER	PLUG	SHIP WEIGHT
WIDTH	DEPTH	HEIGHT			
16-3/4" (425mm)	16-15/16" (429mm)	38-1/2" (978mm)	110-120V~60Hz, 230W, 2.7A	NEMA 5-15P	85.89 lbs (39 kgs)
SHELF DIMENSIONS					
WIDTH	DEPTH				
14-3/8" (365mm)	12-1/8" (307mm)				

ITEM	DESCRIPTION	UOM	CASE
CRD-1	White	Set	1
CRD-1K	Black	Set	1



CRD-1  
White



CRD-1K  
Black

The grate below door flips down to access control panel & On/Off light switch

**IMPORTANT**  
This unit is intended for use in commercial food-service operations, for the cooling and display of sealed food and beverage only.





## ROTATING HEATED & HUMIDIFIED HOLDING DISPLAY MERCHANDISER

Keep hot foods fresher for longer with this heat and humidity controlled merchandiser. The airflow pattern is designed to maintain consistent temperature and humidity around foods and prevent drying, which also enables the unit to recover temperature quickly after doors are opened/closed.

- ◆ Matte black powder-coated exterior, stainless steel interior
- ◆ Clear-view tempered glass on all sides, with server-side easy access swing door
- ◆ Interior illumination showcases food products
- ◆ Digital adjustable thermostat and humidity control
- ◆ Temperature range: 89°F to 194°F (30°C to 90°C)
- ◆ 4-tier round rack continuously rotates - rotation stops when door is opened
- ◆ Each shelf fits up to 18" diameter pan
- ◆ Optional pretzel rack insert available, sold separately
- ◆ One year parts and labor warranty

OVERALL DIMENSIONS			POWER	PLUG	SHIP WEIGHT
LENGTH	DEPTH	HEIGHT			
23-5/8" (600mm)	25-1/4" (641mm)	27-9/16" (700mm)	110-120V-60Hz, 1500W, 13.1A	NEMA 5-15P	85 lbs (38.6 kgs)

ITEM	DESCRIPTION	UOM	CASE
EDM-1K	Heated & Humidified Merchandiser	Set	1
EDM-P39	4-Tier Round Rack, 18" Dia	Each	1
EDM-1PR	Pretzel Rack for EDM-1K	Each	1

## HEATED DISPLAY MERCHANDISERS



NEW



Control Panel

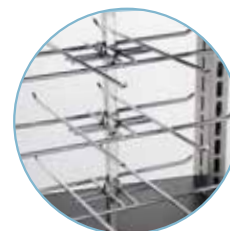

EDM-1PR  
Optional Pretzel Rack



## ELECTRIC HEATED PIZZA/PRETZEL MERCHANDISERS

Passive humidity control with removable water tray.

- ◆ Interior wire shelves hold four (4) 14" pizzas
- ◆ Optional pretzel rack insert, sold separately
- ◆ Display tray/rack insert rotates when door is closed
- ◆ Lighted display panel for branding visuals
- ◆ Adjustable thermostat from 85°F to 195°F (30°C to 90°C)
- ◆ Removable crumb tray
- ◆ One year parts and labor warranty

OVERALL DIMENSIONS			POWER	PLUG	SHIP WEIGHT
LENGTH	DEPTH	HEIGHT			
18-3/8" (466mm)	17-5/8" (447mm)	30-15/16" (785mm)	110-120V-60Hz, 786W, 7.2A	NEMA 5-15P	55.2 lbs (25 kgs)

ITEM	DESCRIPTION	UOM	CASE
EDM-2	Heated Pizza/Pretzel Merchandiser	Set	1
EDM-2PR	Optional Pretzel Rack Insert	Set	1
EDM-2PRS	Pretzel Sign, 5-3/4"H x 16-1/8"W	Each	1
EDM-2PZS	Pizza Sign, 5-3/4"H x 16-1/8"W	Each	1
EDM-P58	4-Tier Round Rack, 14" Dia	Each	5



EDM-2PRS



EDM-2PZS

Translucent plastic display signs  
available for EDM-2  
**Sold Separately**



LIGHTED  
DISPLAY



Control Panel



EDM-2PR  
Optional Pretzel Rack



## HEATED DISPLAY MERCHANDISERS



HDM-13



HDM-26



## COUNTERTOP HEATED DISPLAY MERCHANDISERS

These merchandisers feature passive humidity control with a removable water tray.

- ◆ Removable water pan to add and control humidity
- ◆ Three (3) adjustable shelves inside, top of unit also functional as a shelf
- ◆ Lighted front display for branding visuals
- ◆ Visible thermometer gauge to ensure food keeps at proper temperatures
- ◆ Adjustable thermostat from 85°F to 195°F (30°C to 90°C)
- ◆ Customer-facing front service and rear access doors
- ◆ One year parts and labor warranty

ITEM	OVERALL DIMENSIONS			POWER	PLUG	SHIP WEIGHT
	LENGTH	DEPTH	HEIGHT			
HDM-13	13-11/16" (347mm)	19-9/16" (495mm)	26-1/8" (663mm)	110-120V~60Hz, 800W, 7.6A	NEMA 5-15P	50.71 lbs (23 kgs)
HDM-26	26-11/16" (677mm)	19-9/16" (495mm)	26-1/8" (663mm)	110-120V~60Hz, 1000W, 9.5A		79.37 lbs (36 kgs)

ITEM	DESCRIPTION	UOM	CASE
HDM-13	13-1/2"L	Set	1
HDM-26	26-1/2"L	Set	1



Control Panel

## ELECTRIC COFFEE WARMERS



ECW-2S



ECW-1



ECW-2



## ELECTRIC COFFEE WARMERS

Keep coffee fresh, hot and ready to serve at the optimal serving temperature. Coffee warmers are ideal for any self-service area.

- ◆ Space-saving, low-profile for maximum product visibility
- ◆ Durable stainless steel body with ceramic-coated plates
- ◆ Lighted on/off switch(s)
- ◆ One year parts and labor warranty

ITEM	OVERALL DIMENSIONS			POWER	PLUG	SHIP WEIGHT
	LENGTH	DEPTH	HEIGHT			
ECW-1	6-3/4" (171mm)	7" (178mm)	2-3/8" (60mm)	120V~50/60Hz, 100W	NEMA 5-15P	2.7 lbs (1.2 kgs)
ECW-2	14-1/4" (362mm)	7" (178mm)	2-3/8" (60mm)	120V~50/60Hz, 200W		5.2 lbs (2.35 kgs)
ECW-2S	8" (203mm)	18" (457mm)	5-1/4" (133mm)	120V~50/60Hz, 200W		8.82 lbs (4 kgs)

ITEM	DESCRIPTION	UOM	CASE
ECW-1	Single Burner, 100W	Each	1/6
ECW-2	Double Burners, 200W	Each	1/6
ECW-2S	Step-Up Double Burner, 200W	Each	1



## ELECTRIC STAINLESS STEEL COFFEE URNS

Brew consistent, quality coffee with these percolating coffee urns. Available in either 50 or 100 cup capacities, contents are maintained at the ideal serving temperature until the sight glass indicates when it's time to refill.

- ◆ Large capacity brews 50 or 100 cups of 5oz (148ml) coffee
- ◆ Polished #304 stainless steel construction
- ◆ Twist-locking lid design
- ◆ Cool touch handles
- ◆ Drip less faucet with protected level indicator
- ◆ Waterproof ON/OFF switch with protective cover
- ◆ Stainless steel percolator pipe and plastic filter basket
- ◆ Heating and holding indicator lights
- ◆ Automatic shut-off safety feature
- ◆ One year parts and labor warranty

ITEM	OVERALL DIMENSIONS			POWER	PLUG	SHIP WEIGHT
	LENGTH	DEPTH	HEIGHT			
ECU-50A	12" (304mm)	8-11/16" (220mm)	16-3/8" (415mm)	110-120V-60Hz, 950W, 8A	NEMA 5-15P	7.05 lbs (3.2 kgs)
ECU-100A	13-15/16" (353mm)	10-5/8" (270mm)	19-11/16" (500mm)	110-120V-60Hz, 1500W, 12.5A		9.7 lbs (4.4 kgs)
ECU-100A-I	13-15/16" (353mm)	10-5/8" (270mm)	19-11/16" (500mm)	220-240V-50Hz, 1650W, 6.9-7.5A	VDE	9.7 lbs (4.4 kgs)

ITEM	DESCRIPTION	UOM	CASE
ECU-50A	50-Cup (8L)	Set	1/2
ECU-100A	100-Cup (16L)	Set	1/2
ECU-100A-I	100-Cup (16L), International	Set	1/2



Twist-locking lid



Cool-touch handles



Drip less faucet with protected level indicator



## ELECTRIC COFFEE URNS

AVAILABLE IN  
JULY 2020



NEW

ECU-50A



NEW

ECU-100A  
ECU-100A-I



ECU-50A  
ECU-100A



ECU-100A-I



## ELECTRIC WATER BOILERS

AVAILABLE IN  
JULY 2020



EWB-50A



EWB-100A  
EWB-100A-I



EWB-50A  
ECU-100A



EWB-100A-I



## ELECTRIC STAINLESS STEEL WATER BOILERS

These water boilers are a great addition to any hot beverage service, heating and holding hot water ready to dispense as needed, until the sight glass indicates when it's time to refill.

- ◆ Large 2.1 gallon (8L) or 4.2 gallon (16L) capacities
- ◆ Polished #304 stainless steel construction
- ◆ Twist-locking lid design
- ◆ Cool touch handles
- ◆ Drip less faucet with protected level indicator
- ◆ Waterproof ON/OFF switch with protective cover
- ◆ Stainless steel percolator pipe and plastic filter basket
- ◆ Heating and holding indicator lights
- ◆ Automatic shut-off safety feature
- ◆ One year parts and labor warranty

ITEM	OVERALL DIMENSIONS			POWER	PLUG	SHIP WEIGHT
	LENGTH	DEPTH	HEIGHT			
EWB-50A	12" (304mm)	8-11/16" (220mm)	16-3/8" (415mm)	110-120V-60Hz, 1300W, 10.8A	NEMA 5-15P	6 lbs (2.7 kgs)
EWB-100A	13-15/16" (353mm)	10-5/8" (270mm)	19-11/16" (500mm)	110-120V-60Hz, 1500W, 12.5A		8.4 lbs (3.8 kgs)
EWB-100A-I	13-15/16" (353mm)	10-5/8" (270mm)	19-11/16" (500mm)	220-240V-50Hz, 2250W, 9.4A	VDE	8.4 lbs (3.8 kgs)



ITEM	DESCRIPTION	UOM	CASE
EWB-50A	2.1 Gallon (8L)	Set	1/2
EWB-100A	4.2 Gallon (16L)	Set	1/2
EWB-100A-I	4.2 Gallon (16L), International	Set	1/2



Twist-locking lid



Cool-touch handles



Drip less faucet with protected level indicator

## ELECTRIC 900W WATER PAN



## ELECTRIC WATER PAN

Add ease and convenience with this versatile, energy efficient 120 Volt alternative to chafing fuels. It fits most full-size chafers or use as a freestanding unit.

- ◆ Stands alone or fits standard full-size chafers for an electric alternative (food pan sold separately)
- ◆ Accommodates full-size steam table pans
- ◆ Adjustable controls keep contents at safe serving temp
- ◆ Powerful, efficient 900W heating element heats up fast
- ◆ One year parts and labor warranty

LENGTH	OVERALL DIMENSIONS		POWER	PLUG	SHIP WEIGHT
	DEPTH	HEIGHT			
22-5/8" (575mm)	13-5/8" (346mm)	7" (178mm)	120V-60Hz, 900W, 7.5A	NEMA 5-15P	6 lbs (2.72 kgs)

ITEM	DESCRIPTION	UOM	CASE
EWP-2	900W, Full-Size	Each	1



EWP-2

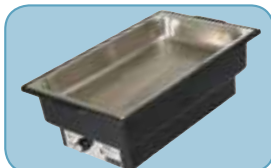

Fits inside standard full-size chafers or use freestanding

The extra large kettle-style soup warmers keep contents at safe serving temperatures for hours, great for serving all day long.

- ◆ Up to 10-quart capacity
- ◆ Adjustable heat control keeps contents at a safe serving temperature without overcooking
- ◆ Stainless steel hinged lid features extra-large ladle slot; hinges allow cover to remain attached while opened and closed when in service with no drips
- ◆ Sets include a removable 18/8 stainless steel bain marie inner pot
- ◆ Double-wall insulated construction allows outer surface to stay cool-to-touch
- ◆ One year parts and labor warranty

## ELECTRIC KETTLE SOUP WARMERS



INSH-7



ESW-INS

### ELECTRIC STAINLESS STEEL KETTLE SOUP WARMER

- ◆ Includes suction-grip label holder

OVERALL DIMENSIONS			POWER	PLUG	SHIP WEIGHT
LENGTH	DEPTH	HEIGHT			
13-3/16" (335mm)	13-3/16" (335mm)	15" (381mm)	120V-60Hz, 400W, 3.6A	NEMA 5-15P	13.14 lbs (5.96 kgs)

ITEM	DESCRIPTION	UOM	CASE
ESW-70	S/S Kettle Soup Warmer Set	Set	1
ESW70-INS	S/S Insert for ESW-70	Each	2
INSH-7	Hinged Cover for ESW70-INS	Each	6/24
ESW70-P6	Replacement Knob	Each	1



ESW-70

### ELECTRIC DELUXE BLACK KETTLE SOUP WARMER

- ◆ Includes customizable magnetic label holder, plus a variety of pre-printed soup name labels

OVERALL DIMENSIONS			POWER	PLUG	SHIP WEIGHT
LENGTH	DEPTH	HEIGHT			
13-3/16" (335mm)	13-3/16" (335mm)	15" (381mm)	110V-50/60Hz, 400W, 3.6A	NEMA 5-15P	12.39 lbs (5.62 kgs)

ITEM	DESCRIPTION	UOM	CASE
ESW-66	Black Kettle Soup Warmer Set	Set	1
ESW-INS	S/S Insert Pot for ESW-66	Each	2
INSH-7	Hinged Cover for ESW-INS	Each	6/24
ESW66-P38	Replacement Knob	Each	1



ESW-66



EWS-SERIES

# ELECTRIC ROUND FOOD COOKERS/WARMERS

With highly efficient heating distribution, Winco's durable and reliable food warmers & cookers/warmers are workhorses that can endure the harshest kitchen environments.

- ◆ Insulated heating compartment for maximum efficiency
- ◆ No-drip rim keeps serving area clean
- ◆ One year parts and labor warranty

FITS 7QT INSET POT



With inset pot



FW-7R250



FW-7R-SERIES

## ELECTRIC ROUND FOOD WARMERS (WET WELL USE ONLY)

- ◆ 3 settings: Low / Medium / High

ITEM	LENGTH	DEPTH	HEIGHT	POWER	PLUG	SHIP WEIGHT
FW-11R250	OVERALL DIMENSIONS			120V~50/60Hz, 750W	NEMA 5-15P	13.5 lbs (6.1 kgs)
	12-1/2" (318mm)	12-1/2" (318mm)	9-5/8" (245mm)			
	WELL DIMENSIONS					
FW-7R250	OVERALL DIMENSIONS			120V~50/60Hz, 550W	NEMA 5-15P	9.48 lbs (4.3 kgs)
	11" (280mm)	11" (280mm)	9-1/2" (241mm)			
	WELL DIMENSIONS					
	8-1/4" (210mm)	8-1/4" (210mm)	6" (153mm)			

ITEM	DESCRIPTION	UOM	CASE
FW-11R250	11 Qt Warmer	Set	1
FW-7R250	7 Qt Warmer	Set	1

FITS 11QT INSET POT



FW-11R500



FW-11R-SERIES

## ELECTRIC ROUND FOOD COOKERS/WARMERS (WET WELL USE ONLY)

- ◆ Heats up to 212°F (100°C)

ITEM	LENGTH	DEPTH	HEIGHT	POWER	PLUG	SHIP WEIGHT
FW-11R500	OVERALL DIMENSIONS			120V~50/60Hz, 1250W	NEMA 5-15P	12.57 lbs (5.7 kgs)
	12-1/2" (318mm)	12-1/2" (318mm)	9-5/8" (245mm)			
	WELL DIMENSIONS					
FW-7R500	OVERALL DIMENSIONS			120V~50/60Hz, 1050W	NEMA 5-15P	9.48 lbs (4.3 kgs)
	11" (280mm)	11" (280mm)	9-1/2" (241mm)			
	WELL DIMENSIONS					
	8-1/4" (210mm)	8-1/4" (210mm)	6" (153mm)			

ITEM	DESCRIPTION	UOM	CASE
FW-11R500	11 Qt Cooker/Warmer	Set	1
FW-7R500	7 Qt Cooker/Warmer	Set	1

## FOOD COOKERS/WARMERS ACCESSORIES

ITEM	DESCRIPTION	UOM	CASE
INS-11.0M	11Qt Inset Pan	Each	6/12
INS-7.0M	7 Qt Inset Pan	Each	6/24
FW11R-ADP	Adaptor Ring	Each	1/6



FW11R-ADP



Adaptor ring quickly converts 11 Qt food cookers/warmers to fit 7 Qt inset pan

**ELECTRIC 4/3 SIZE FOOD WARMER, 1500W  
(WET WELL USE ONLY)**

*This commercial-grade food warmer fits four (4) 1/3-size food pans in the extended 27" long well opening, and allows for other pan configurations. Featuring a heavy-duty stainless steel welded body, the energy efficient design heats quickly.*

- ◆ Energy-efficient design for fast heating
- ◆ Heavy-duty stainless steel welded body
- ◆ Reliable temperature control for graduated heat settings
- ◆ Dedicated indicator light to easily monitor heating status
- ◆ One year parts and labor warranty

OVERALL DIMENSIONS			POWER	PLUG	SHIP WEIGHT
LENGTH	DEPTH	HEIGHT			
29-3/4" (755mm)	14-5/8" (370mm)	10-11/16" (270mm)	120V-50/60Hz, 1500W, 12.5A	NEMA 5-15P	29.43 lbs (13.35kgs)
WELL OPENING					
27" (658mm)	11-13/16" (300mm)	6-5/16" (160mm)			

ITEM	DESCRIPTION	UOM	CASE
FW-L600	4/3 Size Warmer	Set	1
FWS600-P6	Power/Thermostat Knob	Each	1



**ELECTRIC 4/3 SIZE  
FOOD WARMER**



(1) FULL SIZE, (1) 1/3 SIZE



(4) 1/3 SIZE PANS

**27" LONG  
WELL  
OPENING**



FW-L600

*These commercial-grade units accommodate a full-size food pan and allows for other pan configurations. Featuring a heavy-duty stainless steel welded body, the energy efficient design heats quickly.*

- ◆ Energy-efficient design for fast heating
- ◆ Heavy-duty stainless steel welded body
- ◆ Reliable temperature control for graduated heat settings
- ◆ Dedicated indicator light to easily monitor heating status
- ◆ One year parts and labor warranty

**ELECTRIC FULL-SIZE  
FOOD COOKERS/  
WARMERS**

**ELECTRIC FULL-SIZE FOOD COOKER/WARMER, 1500W  
(WET WELL USE ONLY)**

OVERALL DIMENSIONS			POWER	PLUG	SHIP WEIGHT
LENGTH	DEPTH	HEIGHT			
14-5/8" (372mm)	22-1/2" (572mm)	10-5/8" (270mm)	120V-50/60Hz, 1500W, 12.5A	NEMA 5-15P	25 lbs (11.34 kgs)
WELL OPENING					
12" (305mm)	20" (508mm)	6" (153mm)			

ITEM	DESCRIPTION	UOM	CASE
FW-S600	Cooker/Warmer	Set	1
FWS600-P5	Power/Thermostat Knob	Each	1/50



FW-S600

**ELECTRIC FULL-SIZE FOOD WARMER, 1200W  
(WET WELL USE ONLY)**

OVERALL DIMENSIONS			POWER	PLUG	SHIP WEIGHT
LENGTH	DEPTH	HEIGHT			
14-5/8" (372mm)	22-1/2" (572mm)	9-3/8" (238mm)	120V-50/60Hz, 1200W, 10A	NEMA 5-15P	23.2 lbs (10.52 kgs)
WELL OPENING					
12" (305mm)	20" (508mm)	6" (153mm)			

ITEM	DESCRIPTION	UOM	CASE
FW-S500	Warmer	Set	1
FWS500-P11	Power/Thermostat Knob	Each	1/50



FW-S500



# ELECTRIC STRIP HEATERS



ESH-24

ESH-36  
Shown with undermount bracket and hanging chain

INCLUDES HANGING CHAINS



BUILT-IN PLUG



Heating element



Indicator light and toggle switch



SEE PAGE 224 FOR FOOD PANS



Designed with a tubular sheath heating element, these premium quality electric strip heaters provide constant, even, and reliable infrared heating. Undermount and freestanding options available.

- ◆ Heavy-duty one piece extruded aluminum body for durability and cleanliness
- ◆ Aluminum heat reflectors with focused heat pattern to maximize holding times
- ◆ On/off toggle switch for easy, simple operation
- ◆ 70" (178cm) long cord with plug
- ◆ 180 degree full view indicator light
- ◆ One year parts and labor warranty

## UNDERMOUNT ELECTRIC STRIP HEATERS

- ◆ Ideal for pass-through stations or under shelf installations
- ◆ Each unit includes undermount bracket set w/screws and hanging chains

ITEM	OVERALL DIMENSIONS			POWER	PLUG & CORD	SHIP WEIGHT
	LENGTH	DEPTH	HEIGHT			
ESH-24	24" (610mm)	6" (153mm)	2-9/16" (67mm)	120V-50/60Hz, 500W, 4.2A	NEMA 5-15P 70" (178cm) long cord	11.02 lbs (5 kgs)
ESH-36	36" (915mm)	6" (153mm)	2-9/16" (67mm)	120V-50/60Hz, 750W, 6.3A		15.43 lbs (7 kgs)
ESH-48	48" (1220mm)	6" (153mm)	2-9/16" (67mm)	120V-50/60Hz, 1000W, 8.3A		17.64 lbs (8 kgs)
ESH-60	60" (1524mm)	6" (153mm)	2-9/16" (67mm)	120V-50/60Hz, 1400W, 12A		22.05 lbs (10 kgs)
ESH-72	72" (1829mm)	6" (153mm)	2-9/16" (67mm)	120V-50/60Hz, 1800W, 15A		24.25 lbs (11 kgs)

ITEM	DESCRIPTION	UOM	CASE
ESH-24	24"L	Set	1
ESH-36	36"L	Set	1
ESH-48	48"L	Set	1
ESH-60	60"L	Set	1
ESH-72	72"L	Set	1

## FREESTANDING ELECTRIC STRIP HEATER

- ◆ Heavy-duty steel stand with powder-coated painted exterior and rust resistant interior coating
- ◆ Stand adjusts to three heights above work surface to control heat intensity

ITEM	OVERALL DIMENSIONS			POWER	PLUG & CORD	SHIP WEIGHT
	LENGTH	DEPTH	HEIGHT			
ESH-1	26-1/8" (664mm)	14-1/4" (362mm)	18" (457mm)	120V-50/60Hz, 500W, 4.2A	NEMA 5-15P 70" (178cm) long cord	6.61 lbs (3 kgs)
			20-5/8" (524mm)			
			22-7/8" (581mm)			
STRIP HEATER ONLY						
	LENGTH	DEPTH	HEIGHT			
	24-1/4" (616mm)	6" (153mm)	2-9/16" (67mm)			

ITEM	DESCRIPTION	UOM	CASE
ESH-1	Electric Strip Heater, Steel	Set	1
ESH-1-HB	Hanging Bracket for ESH-1	Each	

# UNIVERSAL DUMP STATION PAN HOLDERS

NEW



EHL-PH-B

NEW



EHL-PH-G

## UNIVERSAL DUMP STATION PAN HOLDERS

- ◆ Utilize with heat lamps for cohesive presentation
- ◆ Accommodates 2-1/2" and 4" deep pans

ITEM	DESCRIPTION	UOM	CASE
EHL-PH-B	Black, Fits EHL-3C	Each	1
EHL-PH-G	Gray, Fits ESH-1, EHL-2 & EHL-2C	Each	1

COMPATIBLE WITH WINCO® HEAT LAMPS





## ELECTRIC HEAT LAMPS

Maintain ideal serving temperatures to keep prepared food warm and appetizing under these infrared, twin-bulb heat lamps, featuring maximum adjustability, improved countertop stability and an easy-to-clean, scratch-resistant finish.

- ◆ Compatible with most standard-size food trays
- ◆ Heavy-duty frame with 13 gauge aluminum bulb hoods
- ◆ Two (2) clear, infrared shatter-resistant 250W/120V bulbs included
- ◆ 70" (178cm) long cord with plug
- ◆ One year parts and labor warranty

### 3-POSITION ELECTRIC STEEL TUBING HEAT LAMPS

- ◆ Easy-clean, durable, scratch-resistant electrostatic powder-coated finished hoods and frame
- ◆ 3-position adjustable height to control heat intensity

OVERALL DIMENSIONS			POWER	PLUG & CORD	SHIP WEIGHT
LENGTH	DEPTH	HEIGHTS			
19-1/2" (495mm)	22-1/2" (571mm)	23-5/8" (600mm)	120V-50/60Hz, 500W, 4.2A	NEMA 5-15P  70" (178cm) long cord	6.61 lbs (3 kgs)
		26-1/8" (664mm)			
		28-5/8" (727mm)			
BASE DIMENSIONS					
LENGTH	DEPTH				
18" (457mm)	14" (356mm)				

ITEM	DESCRIPTION	UOM	CASE
EHL-3C	3-Position Heat Lamp, Black	Set	1
EHL-2C	3-Position Heat Lamp, Gray	Set	1

HEAT LAMPS INCLUDE  
2 CLEAR, INFRARED  
SHATTER RESISTANT  
250W/120V BULBS

### 4-POSITION ELECTRIC ALUMINUM TUBING HEAT LAMP

- ◆ 14 gauge heavy-duty aluminum tubing frame
- ◆ Easy-clean brushed aluminum finish
- ◆ 4-position adjustable height to control heat intensity

OVERALL DIMENSIONS			POWER	PLUG & CORD	SHIP WEIGHT
LENGTH	DEPTH	HEIGHTS			
19-1/2" (495mm)	22-1/2" (571mm)	29-3/8" (746mm)	120V-50/60Hz, 500W, 4.2A	NEMA 5-15P  70" (178cm) long cord	7.5 lbs (3.45 kgs)
		27-1/2" (699mm)			
		25-1/2" (648mm)			
		23-3/4" (603mm)			
BASE DIMENSIONS					
LENGTH	DEPTH				
16-1/4" (413mm)	14-1/4" (362mm)				

ITEM	DESCRIPTION	UOM	CASE
EHL-2	4-Position Heat Lamp, Aluminum	Set	1



### INFRARED SHATTER-RESISTANT BULBS FOR HEAT LAMPS INFRARED R40 BULBS

- ◆ Shatter-resistant infrared 250W/120V bulbs
- ◆ R40 bulb with medium E26 base
- ◆ Up to 6,000 hours burn time
- ◆ For commercial food-operations only

ITEM	DESCRIPTION	UOM	CASE
EHL-BR	Red	Each	1/12
EHL-BW	Clear	Each	1/12



**winco**  
**SPECTRUM**  
 COUNTERTOP INDUCTION COOKERS



EICS-SERIES

SEE PAGE 197  
 FOR INDUCTION-  
 READY  
 COOKWARE

EICS-18  
 For U.S. only

EICS-18C  
 For Canada only

EICS-34  
 For U.S. and Canada

**COUNTERTOP INDUCTION COOKERS**

Safer than traditional gas or electric resistance burners, induction cooktops use magnetism to rapidly heat up induction cookware, which in turn heats up food. The ideal choice for tableside, catering and buffet-line cooking, induction cooktops are faster and more efficient than installed gas stovetops.

- ◆ Stainless steel body construction
- ◆ Compact, easy-to-clean, portable
- ◆ Easy to use digitally controlled wattage and temperature from warming to cooking for optimal cooking efficiency, control and speed
- ◆ High-impact and high-heat resistant 11-13/16" x 11-13/16" (299mm x 299mm) glass-ceramic cooking surface
- ◆ Accommodates pan sizes between 4-1/2" (114 mm) to 10-1/2" (267mm)
- ◆ Small-article and pan detection
- ◆ Timer up to 150 min (2-1/2 hours)
- ◆ Auto safety shut-off
- ◆ One year parts and labor warranty

Heat Efficiency Comparison

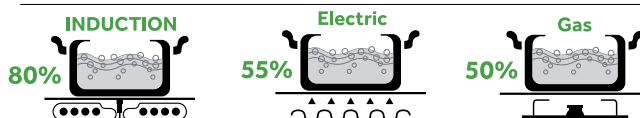

ITEM	OVERALL DIMENSIONS			POWER	PLUG	SHIP WEIGHT
	LENGTH	DEPTH	HEIGHT			
EICS-18				120V-60Hz, 1800W, 15A	NEMA 5-15P	37.5 lbs (17.01 kgs)
EICS-18C	14-3/16" (360mm)	18-1/8" (460mm)	5-1/8" (129mm)	120V-60Hz, 1800W, 15A	NEMA 5-20P	
EICS-34				240V-60Hz, 3400W, 14A	NEMA 6-20P	

ITEM	DESCRIPTION	UOM	CASE
EICS-18	US	Set	1/2
EICS-18C	Canada	Set	1/2
EICS-34	US and Canada	Set	1/2

**ECONOMY INDUCTION COOKER**



LOW PROFILE



**ECONOMY COUNTERTOP INDUCTION COOKER**

- ◆ Up to 1800 watts of continuous heat to cook everything from a low simmer to a rolling boil
- ◆ Easy-touch controls with adjustable power levels (1-10)
- ◆ Ceramic glass surface with small-article and pan detection, 4-3/4"-10-1/4" induction cookware
- ◆ Durable stainless steel and plastic body construction
- ◆ Timer up to 180 min. (3 Hours)
- ◆ One year parts and labor warranty

ITEM	OVERALL DIMENSIONS			POWER	PLUG	SHIP WEIGHT
	LENGTH	DEPTH	HEIGHT			
EIC-400E	11-3/4" (299mm)	15-3/4" (400mm)	2-3/4" (70mm)	120V-60Hz, 1800W, 15A	NEMA 1-15P	13.25 lbs (6.01 kgs)

ITEM	DESCRIPTION	UOM	CASE
EIC-400E	Induction Cooker	Each	1/4

EIC-400E  
 For U.S. only

## DROP-IN INDUCTION COOKERS

Safer than traditional gas or electric resistance burners, induction cooktops use magnetism to rapidly heat up induction cookware, which in turn heats up food. The drop-in induction cookers install directly into the countertop for a built-in, streamlined presentation. Ideal for tableside, catering or buffet-line cooking.

- ◆ Powder-coated steel body construction
- ◆ Compact drop-in-counter design that can be flush, recessed, or mounted with optional trim ring
- ◆ Easy to use digital control with ten (10) power wattage levels from warming to cooking for optimal cooking efficiency, control and speed
- ◆ Remote control panel provided with 36" (915mm) quick-connect cord
- ◆ High-impact and high-heat resistant 11-13/16" x 11-13/16" (299mm x 299mm) glass-ceramic cooking surface
- ◆ Accommodates pan sizes between 4-1/2" (114 mm) to 10-1/2" (267mm)
- ◆ Small-article and pan detection
- ◆ Timer up to 150 min (2-1/2 hours)
- ◆ Auto safety shut-off
- ◆ One year parts and labor warranty

ITEM	OVERALL DIMENSIONS			POWER	PLUG & CORD	SHIP WEIGHT
	LENGTH	DEPTH	HEIGHT			
EIDS-18	12-5/8"	13-7/16"	3-7/8"	120V-60Hz, 1800W, 15A	NEMA 5-15P	27.7 lbs (12.56 kgs)
EIDS-18C	(320mm)	(340mm)	(98mm)	120V-60Hz, 1800W, 15A	NEMA 5-20P	
EIDS-34				240V-60Hz, 3400W, 14A	NEMA 6-20P	

ITEM	DESCRIPTION	UOM	CASE
EIDS-18	US	Set	1/2
EIDS-18C	Canada	Set	1/2
EIDS-34	US and Canada	Set	1/2

### TRIM RING FOR DROP-IN INDUCTION COOKERS

For a sleek look, install the drop-in induction cookers with this additional trim ring to protect the glass edges and hide the countertop cutout.

ITEM	DESCRIPTION	UOM	CASE
EIDS-TR	Stainless Steel Trim Ring	Each	1

## winco® SPECTRUM™ DROP-IN INDUCTION COOKERS



EIDS-SERIES

Control panel mounts to front of counter where drop-in cooker is installed



Drop-in induction cooker mounted in counter

EIDS-18   
For U.S. only

EIDS-18C   
For Canada only

EIDS-34   
For U.S. and Canada



EIDS-TR

## PORTABLE BUTANE GAS STOVE

This portable and compact butane gas stove is great for camping, outdoor parties or catered events.

- ◆ Single, top-quality solid brass burner, built-in pot support and wide base for stability
- ◆ Manually adjustable heat range with up to 9,500 BTU of power
- ◆ Comes with a black impact-resistant hard plastic carrying case for easy transport
- ◆ Automatic gas shut-off safety feature
- ◆ Uses standard 8 oz Butane DOT-2P canister (sold separately)

ITEM	OVERALL DIMENSIONS			POWER	SHIP WEIGHT
	LENGTH	DEPTH	HEIGHT		
PGS-1K	13-3/8"	10-3/4"	4-1/4"	9500 BTUs	5.17 lbs (2.35 kgs)
	(340mm)	(273mm)	(108mm)		

ITEM	DESCRIPTION	UOM	CASE
PGS-1K	Portable Gas Stove w/Case, Black, 9500 BTUs, Brass Burner	Each	1/6

## BUTANE GAS STOVE



Fits standard Butane canister



**winco**  
**SPECTRUM**  
IMMERSION CIRCULATOR



**CONSISTENT  
MORE  
NUTRITION  
MORE  
FLAVOR  
RESULTS**



ESVI-1



Easy-press controls

Get cooking with the Spectrum line of sous vide equipment. With precise temperature control and by reducing heat fluctuations, food retains moisture, nutrition, and flavor for perfect results every time.

- ◆ Precise temperature accuracy: +1°F (0.5°C)
- ◆ Temperature range: 41°F to 210°F (5°-99°C)
- ◆ Timer setting range: 5 minutes – 99 hours
- ◆ LED display: Optional °F / °C, with last temperature and time memory when turned on
- ◆ One year parts and labor warranty

**IMMERSION CIRCULATOR**

- ◆ Attached clamp adjusts to fit over container
- ◆ Maximum volume capacity: 7.9 gallons (30L)

OVERALL DIMENSIONS			POWER	PLUG	SHIP WEIGHT
LENGTH	DEPTH	HEIGHT			
3-11/16" (93.5mm)	6-9/16" (166.5mm)	12-7/8" (326mm)	110-120V-60Hz, 900W, 7.5A	NEMA 5-15P	4.41 lbs (2 kgs)

ITEM	DESCRIPTION	UOM	CASE
ESVI-1	Immersion Circulator	Set	1/6



**winco**  
**SPECTRUM**  
THERMAL CIRCULATOR



**THERMAL CIRCULATOR**

- ◆ Wire clip on side conveniently holds lid when open
- ◆ Built-in faucet and drain for easy water removal
- ◆ Included tray with 8 slots for cooking multiple vacuum-sealed portions
- ◆ Maximum volume capacity: 7.4 gallons (28L)

OVERALL DIMENSIONS			POWER	PLUG	SHIP WEIGHT
LENGTH	DEPTH	HEIGHT			
22-1/2" (570.5mm)	17-7/16" (442.2mm)	12-3/16" (308.3mm)	110-120V-60Hz, 1800W, 15A	NEMA 5-15P	18.74 lbs (8.5 kgs)

ITEM	DESCRIPTION	UOM	CASE
ESVC-28	Thermal Circulator	Set	1
ESVC-P17	NEMA 5-20P Cord/Plug (Canada)	Each	1



ESVC-28



Built-in faucet



Wire clip holds lid



Sectioned tray

**VACUUM SEALER**

Vacuum packing makes sous vide cooking possible. When air is removed, foods prepared this way retain moisture, nutrition and flavor. This process is also ideal for food preservation, marinating, saving pre-cooked food, and more.

- ◆ Compact design with large 3-gallon capacity vacuum chamber
- ◆ Dry vacuum pump and easy-to-use touch controls with adjustable vacuum & seal times, or instant-seal function
- ◆ Stainless steel body construction
- ◆ Heavy-duty transparent lid; dome adds to inner chamber height allowing larger items to fit for sealing
- ◆ Single one-piece 11-1/2" seal bar with bag clamp
- ◆ One year parts and labor warranty

OVERALL DIMENSIONS			VOLTS	PLUG	SHIP WEIGHT
LENGTH	DEPTH	HEIGHT			
14-3/16" (359mm)	16-3/4" (425mm)	14-7/8" (377mm)	110-120~ 60Hz, 630W, 5.25A	NEMA 5-15P	59.7 lbs (27.1 kgs)
CHAMBER DIMENSIONS					
LENGTH	DEPTH	HEIGHT			
12" (300mm)	13-7/8" (350mm)	4-5/16" (110mm)			
SEAL BAR		SEAL WIRE			
11-1/2" (295mm)		5/16" (7.9mm)			

ITEM	DESCRIPTION	UOM	CASE
EVPM-12	Vacuum Sealer	Set	1
EVPM-P1	Seal Bar Assembly	Each	1



**winco**  
**SPECTRUM**  
VACUUM SEALER



11-1/2" seal bar with bag clamp



EVPM-12

**SOUS VIDE ACCESSORIES**

ITEM	DESCRIPTION	UOM	CASE
ESV-BH	Multi Ring Bag Stand	Each	1/4
ESV-IB	Insulation Balls	Pack	1/48

**winco**  
**SPECTRUM**  
SOUS VIDE ACCESSORIES

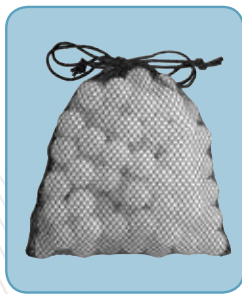

100 pieces with mesh bag



ESV-1 with ESV-IB insulation balls, to reduce evaporation and hold heat in

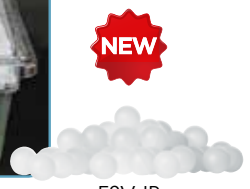

ESV-IB

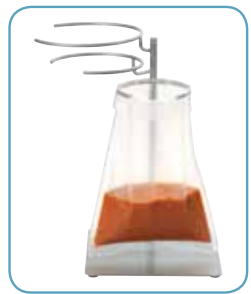

Bag stand conveniently holds various sizes of vacuum bags open for easy filling

**RING SIZES**  
Large: 7" dia  
Medium: 5-5/8" dia  
Small: 4-3/8" dia



13"H



ESV-BH

## ELECTRIC COUNTERTOP CONVECTION OVENS



ECO-250



ECO-500



## ELECTRIC COUNTERTOP CONVECTION OVENS

Convection ovens are perfect for baked goods, snack foods, pizzas, and warm sandwiches. These compact designs are great for coffee shops, kiosks, snack bars, and restaurants.

- ◆ Stainless steel construction
- ◆ Heat settings range from 150°F to 500°F (65°C to 260°C)
- ◆ Built-in 120 minute timer with "Stay On" feature
- ◆ Dual pane tempered glass door
- ◆ Spacious interior includes three chrome wire rack shelves
- ◆ Whisper quiet circulation for even heating

ITEM	OVERALL DIMENSIONS			POWER	PLUG	SHIP WEIGHT
	LENGTH	DEPTH	HEIGHT			
ECO-250	18-3/4" (477mm)	19-7/8" (505mm)	15" (381mm)	120V-60Hz, 1440W, 12A	NEMA 5-15P	34.83 lbs (15.8 kgs)
ECO-500	22-1/2" (572mm)	22-3/4" (579mm)	17-3/4" (451mm)			120V-60Hz, 1600W, 13.3A

ITEM	DESCRIPTION	UOM	CASE
ECO-250	Quarter-Size, 0.8 Cubic Ft	Set	1
ECO-500	Half-Size, 1.5 Cubic Ft	Set	1
ECO-P5-25	Wire Rack for ECO-250	Each	1
ECO-P5-50	Wire Rack for ECO-500	Each	1
ALXP-1310H	Aluminum 1/4-Size Sheet Pan for ECO-250	Each	24
ALXP-1813H	Aluminum 1/2-Size Sheet Pan for ECO-500	Each	12



Spacious interior

## ELECTRIC PIZZA OVEN



IMPROVED QUALITY



Easily fits 12" pizza



EPO-1



## ELECTRIC COUNTERTOP PIZZA OVEN

Great for snack bars, concession stands, and any place where customers are looking for a snack on-the-go, this countertop pizza oven makes it easy to add hot pizza and snacks to your menu.

- ◆ Heats up to 600°F (315°C); dual independently controlled heating elements
- ◆ 60-minute timer with bell includes "Stay On" feature
- ◆ Pizza tray handle folds for storage
- ◆ Includes crumb tray
- ◆ Easily fits a pizza up to 12" diameter
- ◆ One year parts and labor warranty

ITEM	OVERALL DIMENSIONS			POWER	PLUG	SHIP WEIGHT
	LENGTH	DEPTH	HEIGHT			
EPO-1	20-7/8" (530mm)	14-3/4" (375mm)	9-1/4" (235mm)	120V-50/60Hz, 1500W, 12.5A	NEMA 5-15P	26.9 lbs (12.2 kgs)

ITEM	DESCRIPTION	UOM	CASE
EPO-1	Pizza Oven w/Bell Timer and "Stay On" Function	Set	1
EPO-P7	Crumb Tray Knob for EPO-1	Each	1

**winco**  
**SPECTRUM**  
 STAINLESS STEEL  
 MICROWAVES

At a powerful 1000W, with a unique motor-driven bottom antenna for efficient energy distribution, these commercial microwaves provide consistent results with frequent, repeated use, essential for quick-serve restaurants, concession stands, prep stations and more. Attractive, fully stainless steel interior and exterior units are reliable, sturdy and easy-to-clean.

- ◆ 1,000 watts of cooking power for quick heating
- ◆ Motor driven bottom antenna for efficient energy distribution and consistent results
- ◆ Engineered for commercial kitchen use
- ◆ Stainless steel interior with bottom ceramic plate
- ◆ Ample 0.9 cubic feet (25 L) oven capacity
- ◆ Accommodates 12" (30.5 cm) diameter platter
- ◆ Backlit LED display
- ◆ Interior oven light
- ◆ One year warranty

**TOUCH CONTROL MICROWAVE**

- ◆ 3 customizable key-beep volumes

OVERALL DIMENSIONS			POWER	PLUG	SHIP WEIGHT
LENGTH	DEPTH	HEIGHT			
20-1/8" (511mm)	17" (432mm)	12-1/4" (311mm)	120V~60Hz, 1000W, 12A	NEMA 5-15P	35.71 lbs (16.2 kgs)

ITEM	DESCRIPTION	UOM	CASE
EMW-1000ST	Spectrum Commercial Microwave, Touch, Stainless Steel, 1,000 W	Set	1



EMW-1000ST

**DIAL CONTROL MICROWAVE**

OVERALL DIMENSIONS			POWER	PLUG	SHIP WEIGHT
LENGTH	DEPTH	HEIGHT			
20-1/2" (521mm)	18" (457mm)	12-5/16" (313mm)	120V~60Hz, 1000W, 12A	NEMA 5-15P	44.09 lbs (20 kgs)

ITEM	DESCRIPTION	UOM	CASE
EMW-1000SD	Spectrum Commercial Microwave, Dial, Stainless Steel, 1,000 W	Set	1



EMW-1000SD

**winco**  
**SPECTRUM**  
 COUNTERTOP  
 CONVEYOR TOASTER

**NEW**  
**700**  
 SLICES  
 PER  
 HOUR



**ETL** **us** **ETL**  
 Intertek Intertek  
 ECT-700

**CONVEYOR TOASTER**

The ideal choice for serving perfectly toasted breads, bagels, small pizzas and similar dough-based products. Easy-to-operate and can keep pace with even the busiest kitchens and buffets.

- ◆ Heavy duty all stainless steel "Cool-Touch" exterior
- ◆ Large 2-1/2" high feeder opening with a 10-3/8" (2 slice) wide conveyor accepts over-sized bagels and Texas Toast
- ◆ Rounded, extra-wide curved return chute prevents larger foods items from getting caught
- ◆ Variable conveyor-speed dial control for optimal doneness
- ◆ Choose between independent or dual-heating elements for added flexibility
- ◆ Energy Saver-Hold mode saves up to 75 percent energy during slow periods when unit is not in use and allows quick recovery to temperature.
- ◆ Removable crumb tray
- ◆ Adjustable legs with non-skid foot add stability
- ◆ One year parts and labor warranty

OVERALL DIMENSIONS			POWER	PLUG	SHIP WEIGHT
LENGTH	DEPTH	HEIGHT			
14-5/8" (370mm)	16-9/16" (420mm)	16-3/8" (415mm)	208/240V- 50/60Hz, 1800/2400W, 8.6/10A	NEMA 6-15P	44.53 lbs (20.2 kgs)

ITEM	DESCRIPTION	UOM	CASE
ECT-700	700 Slices per Hour	Set	1



**STACKING KIT**

**STACKING KIT FOR CONVEYOR TOASTERS**

- ◆ Save on counter space while maximizing productivity
- ◆ Toast multiple varieties simultaneously
- ◆ Durable stainless steel construction
- ◆ Designed to vertically stack two (2) ECT toasters

ITEM	DESCRIPTION	UOM	CASE
ECT-SK	Stacking Kit	PC	1/6

**NEW**



ECT-SK



Stacking kit shown on conveyor toaster



2 vertically stacked conveyor toaster units



**COUNTERTOP DEEP FRYERS**

Countertop fryers are a great, easy addition to any food service operation. Great for chicken, fries, onion rings, tempura, shrimp, vegetables and more!

- ◆ Commercial fry basket(s) with safe secure handle
- ◆ Expedient heat-up
- ◆ Removable stainless steel fry well(s) for easy cleaning; fry well cover(s) included
- ◆ Removable power head(s)
- ◆ One year parts and labor warranty

**ELECTRIC COUNTERTOP DEEP FRYERS**

**ELECTRIC COUNTERTOP SINGLE WELL DEEP FRYER**

- ◆ 16 lb oil capacity
- ◆ 8 liters = 16 lbs = 2.11 gallons

OVERALL DIMENSIONS			POWER	PLUG	SHIP WEIGHT
LENGTH	DEPTH	HEIGHT			
11-3/4" (298mm)	16" (406mm)	13-5/8" (346mm)	120V-50/60Hz, 1750W, 14.6A	NEMA 5-15P	19.9 lbs (9.03 kgs)

ITEM	DESCRIPTION	UOM	CASE
EFS-16	Single Well	Set	1
EFST-P30	Fry Basket	Each	1



Cover(s) for well(s) are included



EFS-16



EFST-P30

**ELECTRIC COUNTERTOP TWIN WELL DEEP FRYER**

- ◆ 32 lb oil capacity
- ◆ 2 x 8 liters (16 liters combined) = 32 lbs; total = 4.22 gallons

OVERALL DIMENSIONS			POWER	PLUG	SHIP WEIGHT
LENGTH	DEPTH	HEIGHT			
21-1/4" (616mm)	16" (406mm)	13-5/8" (346mm)	120V-50/60Hz, 1750W, 14.6A (x2)	NEMA 5-15P (x2)	34.8 lbs (15.8 kgs)

ITEM	DESCRIPTION	UOM	CASE
EFT-32	Double Well	Set	1
EFST-P30	Fry Basket	Each	1



SEE PAGE 222 FOR FRYER ACCESSORIES



Cover(s) for well(s) are included



EFT-32

# ELECTRIC COUNTERTOP SANDWICH GRILLS

## ELECTRIC COUNTERTOP SANDWICH GRILLS

Flat-top grills are great for sandwiches, and widely used for breakfast eggs/meats, flat breads, quesadillas and more.

- ◆ Stainless steel construction; flat cast iron grill surface
- ◆ Hinged balanced top plate adjusts to food thickness
- ◆ Removable crumb and grease tray
- ◆ Power and ready light(s)
- ◆ Includes steel-bristle brush w/wooden handle for cleaning
- ◆ Adjustable thermostat up to 600°F (315°C)
- ◆ One year parts and labor warranty



ESG-1



### SINGLE FLAT SANDWICH GRILL

OVERALL DIMENSIONS			POWER	PLUG	SHIP WEIGHT
LENGTH	DEPTH	HEIGHT			
17" (432mm)	12" (305mm)	8" (203mm)	120V-50/60Hz, 1750W, 15A	NEMA 5-15P	46.6 lbs (21.18) kgs)
GRILL SURFACE					
LENGTH	DEPTH				
14" (356mm)	9" (229mm)				

ITEM	DESCRIPTION	UOM	CASE
ESG-1	Single Grill	Set	1
EPSP-P52S	Handle for ESG-1	Each	1
EPSP-P28	Black Knob w/Red Ring	Set	1
EPSP-P53S	Grease Tray for ESG-1	Each	1
EPSP-P56	Steel Bristle Brush w/Wooden Handle	Each	



ESG-2



### DOUBLE FLAT SANDWICH GRILL

OVERALL DIMENSIONS				POWER	PLUG	SHIP WEIGHT
LENGTH	DEPTH	HEIGHT				
22-1/2" (572mm)	12" (305mm)	8" (203mm)		120V-50/60Hz, 1750W, 15A (x2)	NEMA 5-15P (x2)	57 lbs (25.9) kgs)
GRILL SURFACE		GRILL PLATES				
LENGTH	DEPTH	LENGTH	DEPTH			
19" (483mm)	9" (229mm)	9" (229mm)	9" (229mm)			

ITEM	DESCRIPTION	UOM	CASE
ESG-2	Double Grill	Set	1
EPSP-P52D	Handle for ESG-2	Each	1
EPSP-P28	Black Knob w/Red Ring	Set	1
EPSP-P53D	Grease Tray for ESG-2	Each	1
EPSP-P56	Steel Bristle Brush w/Wooden Handle	Each	1

**ELECTRIC COUNTERTOP PANINI GRILLS**

*This ribbed grill offers versatility and can be used in many types of food service operations, from paninis and wraps, to grilled vegetables or chicken.*

- ◆ Stainless steel construction; ribbed cast iron grill surface
- ◆ Hinged balanced top plate adjusts to food thickness
- ◆ Removable crumb and grease tray
- ◆ Power and ready light(s)
- ◆ One year parts and labor warranty

**ELECTRIC COUNTERTOP PANINI GRILLS**



Closed



**SINGLE PANINI GRILL**

- ◆ Includes steel-bristle brush w/plastic handle for cleaning
- ◆ Adjustable temperature up to 570°F (298°C)

OVERALL DIMENSIONS			POWER	PLUG	SHIP WEIGHT
LENGTH	DEPTH	HEIGHT			
16-1/8" (410mm)	14-3/4" (375mm)	9-3/4" (248mm)	120V-50/60Hz, 1750W, 14.6A	NEMA 5-15P	69 lbs (32.3 kgs)
GRILL DIMENSIONS					
LENGTH	DEPTH				
14" (356mm)	12" (305mm)				

ITEM	DESCRIPTION	UOM	CASE
EPG-1C	Single Grill	Set	1
EPG-CP8	Steel Brush for EPG-1C	Each	1
EPG-CP3	Grease Tray for EPG-1C	Each	1

**CAST IRON FLAT TOP GRIDDLE PLATE**

*Convert the Winco® Panini Grill (EPG-1C) into a flat top griddle with this easy to install adaptor plate.*

- ◆ Size: 14-3/8" (365mm) x 11-7/8" (302mm)
- ◆ Pre-seasoned heavy-duty cast iron construction
- ◆ 1/4" raised edges collect, contain and direct grease to front trough
- ◆ Ribbed underside nests tightly with panini plate for efficient high-heat transfer

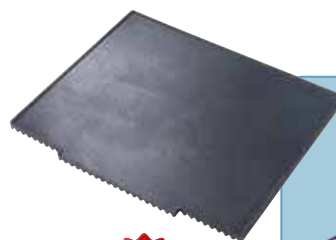

EPG-RF1C



EPG-RF1C easily installs on EPG-1C

OVERALL DIMENSIONS			MATERIAL	SHIP WEIGHT
LENGTH	DEPTH			
14-3/8" (365mm)	11-7/8" (302mm)		Pre-Seasoned Cast Iron	12.2 lbs (5.5 kgs)

ITEM	DESCRIPTION	UOM	CASE
EPG-RF1C	Cast Iron Flat Top Griddle Plate for EPG-1C	Each	1

**DOUBLE RIBBED PANINI GRILL**

- ◆ Includes steel-bristle brush w/wooden handle for cleaning
- ◆ Adjustable thermostat up to 600°F (315°C)

OVERALL DIMENSIONS				POWER	PLUG	SHIP WEIGHT
LENGTH	DEPTH	HEIGHT				
22-1/2" (572mm)	12" (305mm)	8" (203mm)		120V-50/60Hz, 1750W, 15A (x2)	NEMA 5-15P (x2)	60 lbs (27.2 kgs)
GRILL SURFACE		GRILL PLATES				
LENGTH	DEPTH	LENGTH	DEPTH			
19" (483mm)	9" (229mm)	9" (229mm)	9" (229mm)			

ITEM	DESCRIPTION	UOM	CASE
EPG-2	Double Grill	Set	1
EPG-P52D	Handle for EPG-2	Each	1
EPG-P28	Black Knob w/Red Ring	Set	1
EPG-P53D	Grease Tray for EPG-2	Each	1
EPG-P56	Steel Bristle Brush w/Plastic Handle		



## ELECTRIC RICE COOKER



RC-P300



RC-P300



RC-P300PN

## ELECTRIC RICE COOKER

Assembled with premium electrical parts from Korea and Japan, Winco's electric rice cooker makes up to 60 cups of delicious rice.

- ◆ Holds up to 30 cups of uncooked rice
- ◆ Inner pot seals in moisture
- ◆ Includes cover, inner pot, measuring cup and serving paddle
- ◆ One year parts and labor warranty

OVERALL DIMENSIONS			POWER	PLUG	SHIP WEIGHT
LENGTH	DEPTH	HEIGHT			
15-11/16" (398mm)	15-11/16" (398mm)	12-3/8" (315mm)	110V-50/60Hz, 1550W, 14A	NEMA 5-15P	17.64 lbs (8 kgs)

ITEM	DESCRIPTION	UOM	CASE
RC-P300	Rice Cooker	Set	1
RC-P300PN	Inner pot for RC-P300	Each	1
RC-F	Fuse for RC-P300 Can be used in most commercial rice cookers	Each	1

## ELECTRIC RICE COOKER/WARMER



RC-S300



RC-S300



RC-S300PN

## ADVANCED ELECTRIC RICE COOKER/WARMER WITH HINGED COVER

Both a cooker and warmer, the Advanced Electric Rice Cooker from Winco is designed to keep rice at the ideal serving temperature and texture.

- ◆ Holds up to 30 cups of uncooked rice or up to 60 cups of cooked rice
- ◆ Fingerprint-proof satin finish; heavy-duty stainless steel body
- ◆ Non-stick inner pot seals in moisture
- ◆ Energy efficient heat absorption system
- ◆ Automatically keeps rice warm for up to 6 hours
- ◆ Major electrical parts made in Korea/Japan
- ◆ Includes inner pot, measuring cup and serving paddle
- ◆ One year parts and labor warranty

OVERALL DIMENSIONS			POWER	PLUG	SHIP WEIGHT
LENGTH	DEPTH	HEIGHT			
17-1/2" (445mm)	17-1/2" (445mm)	15" (381mm)	110V-50/60Hz, 1550W, 14A	NEMA 5-15P	24.6 lbs (11.16 kgs)

ITEM	DESCRIPTION	UOM	CASE
RC-S300	Rice Cooker/Warmer, Hinged Lid	Set	1
RC-S300PN	Inner pot for RC-S300	Each	1
RC-F1	Fuse for RC-S300	Each	1

## ELECTRIC 100-CUP RICE WARMER

Premium electrical parts are the foundation for the consistent quality and dependability of this 100-cup electric rice warmer from Winco.

- ◆ Holds up to 100 cups of cooked rice for warming
- ◆ Fingerprint-proof satin finish; heavy-duty stainless steel body
- ◆ Non-stick inner pot seals in moisture
- ◆ Energy efficient heat absorption system
- ◆ Keeps contents warm for up to 12 hours
- ◆ Major electrical parts made in Korea/Japan
- ◆ Includes rice paddle
- ◆ One year parts and labor warranty

OVERALL DIMENSIONS			POWER	PLUG	SHIP WEIGHT
LENGTH	DEPTH	HEIGHT			
16-13/16" (427mm)	16-13/16" (427mm)	17-1/2" (445mm)	110V-50/60Hz, 84W, 0.76A	NEMA 5-15P	19.2 lbs (8.71 kgs)



ITEM	DESCRIPTION	UOM	CASE
RW-S450	Electric Rice Warmer, 100-Cup	Set	1
RW-450P	Inner pot for RW-S450	Each	1
RW-F	Fuse for RW-S450 Can be used in most commercial rice warmers	Each	1

## ELECTRIC 100-CUP RICE WARMER



RW-S450



RW-S450



RW-450P



## PANASONIC 23-CUP COMMERCIAL ELECTRIC RICE COOKER

- ◆ Stainless steel lid; removable aluminum alloy inner pot
- ◆ Built-in thermal safety fuse
- ◆ Automatic shut-off
- ◆ Keeps rice warm up to 2 hours
- ◆ One year manufacturer-direct warranty
- ◆ Panasonic warranty only covers purchases made in the United States

OVERALL DIMENSIONS			POWER	PLUG	SHIP WEIGHT
LENGTH	DEPTH	HEIGHT			
16-7/8" (429mm)	14-7/8" (378mm)	11-7/8" (302mm)	120V-60Hz, 1550W, 13A	NEMA 5-15P	15.3 lbs (6.94 kgs)

ITEM	DESCRIPTION	UOM	CASE
SR-42HZP-D	Panasonic Rice Cooker	Set	1

## PANASONIC ELECTRIC RICE COOKER



SR-42HZP-D



**winco**  
**SPECTRUM**  
 COUNTERTOP ELECTRIC GRIDDLES



**NEW** EGD-24M



**NEW** EGD-36M



**COUNTERTOP ELECTRIC GRIDDLES**

Spectrum griddles have a wide heating range, from frying eggs on low to cooking burgers with high heat, all on the half-inch thick polished steel grill surface. Independent controls further regulate the heating zones. The extra-tall steel wall backsplash enclosure helps to minimize grease splatters.

- ◆ Solid 1/2" thick polished steel plate for fast heat up and high heat retention
- ◆ Heavy gauge stainless steel body with 3" high backsplash; sides taper back to front
- ◆ Large-volume removable grease drawer with weep hole and baffle
- ◆ Heavy duty, stainless steel adjustable legs for stability
- ◆ Compatible for 1-phase or 3-phase operation (field convertible)
- ◆ 3-1/4" full width grease trough
- ◆ One year parts and labor warranty

ITEM	OVERALL DIMENSIONS			POWER	PLUG	SHIP WEIGHT
	LENGTH	DEPTH	HEIGHT			
EGD-24M	24" (610mm)	21-3/4" (551mm)	12-7/8" (327mm)	208/240V- 50/60 Hz, 4200/5600W, 20.2/23.4A, 1-phase	NEMA L6-30P	116.84 lbs (53 kg)
EGD-36M	36" (913mm)	21-3/4" (551mm)	12-7/8" (327mm)	208/240V- 50/60 Hz, 6300/8400W, 30.29/35A, 1-phase	Field-wired by others	159.61 lbs (72.4 kg)

Note: Cooking surface depth 16-1/2"(419mm)

ITEM	DESCRIPTION	UOM	CASE
EGD-24M	24" Griddle, 2 Heat Zones	Set	1
EGD-36M	36" Griddle, 3 Heat Zones	Set	1
EGD-MP6	Replacement Knob	Each	1

**winco**  
**SPECTRUM**  
 GAS STOCK POT STOVE

2 INFINITE HEAT CONTROLS



FOR USE ON THE FLOOR

**GAS STOCK POT STOVE, FLOOR USE**

The Spectrum stock pot stove is designed for the kitchen that has limited space and requires a low work height for large pots. This unit is equipped with a high-performance triple-ring burner, heavy duty single-piece cast iron top grate, removable crumb tray and a storage area below the control panel. Includes an LP conversion kit.

- ◆ High performance single (1) grate with three (3) concentric ring burners for a total output of 80,000 BTUH
- ◆ Dual infinite heat controls
- ◆ Stainless steel body, legs and drip pan
- ◆ Heavy duty cast iron grate
- ◆ Standing pilot ignition system
- ◆ 3/4" rear gas connection with regulator
- ◆ Convenient storage area in cabinet
- ◆ Conversion kit allows the use of propane or natural gas
- ◆ One year parts and labor warranty

ITEM	DESCRIPTION	UOM	CASE
NGSP-1	18" Gas Stock Pot Stove	Set	1
NG-Knob	Replacement Metal Knob	Each	1

# OF BURNERS	# OF RINGS	BTU/PER NAT/LP	TOTAL BTU/HR	PRESSURE IN. W.C.	DIMENSIONS			GRATE SURFACE		SHIP WEIGHT
					WIDTH	DEPTH	HEIGHT	WIDTH	DEPTH	
2	3	40,000	80,000	5 / 10	17.9" (454.6mm)	21.38" (543mm)	25.7" (652.7mm)	17.69" (449.3mm)	21.38" (543mm)	132 lbs (60 kgs)

Note: Depths do not include gas inlet pipe, located at rear of the unit.



NGSP-1



**COUNTERTOP GAS HOT PLATES, NATURAL / LP**

Spectrum hot plates are designed with durable stainless steel construction and a cool-touch front plate rail that runs the full length. These units are equipped with infinite heat controls, high-performance burners, heavy-duty cast iron top grates, and removable grease/drip pan.

- ◆ High performance burners, each with output of 25,000 BTUH
- ◆ Infinite heat controls
- ◆ Stainless steel body, adjustable legs 4" to 6" and drip pan; non-skid feet
- ◆ Heavy-duty 12" x 12" cast iron grates
- ◆ 5" wide cool-touch stainless front steel plate rail provides safety and knob protection
- ◆ Standing pilot ignition system, one per burner
- ◆ 3/4" rear gas connection with regulator
- ◆ Conversion kit allows the use of propane or natural gas
- ◆ One year parts and labor warranty

ITEM	DESCRIPTION	UOM	CASE
NGHP-2	12" Hot Plate, 2 Burners	Set	1
NGHP-4	24" Hot Plate, 4 Burners	Set	1
NGHP-6	36" Hot Plate, 6 Burners	Set	1
NG-Knob	Replacement Metal Knob	Each	1

**winco® SPECTRUM™**  
**COUNTERTOP GAS HOT PLATES**



**NEW**

NGHP-2



**NEW**

NGHP-4



**NEW**

NGHP-6



Adjustable legs

MODEL	# OF BURNERS	BTU/ BURNER	TOTAL BTU/HR	PRESSURE IN. W.C.	DIMENSIONS			GRATE SURFACE		SHIP WEIGHT
					LENGTH	DEPTH	HEIGHT	LENGTH	DEPTH	
NGHP-2	2	25,000	50,000	4" / 10"	12" (304.8mm)	34-1/8" (86.6mm)	15" (381mm)	12" (304.8mm)	24" (609.6mm)	79 lbs (36 kgs)
NGHP-4	4		100,000		24" (609.6mm)	includes gas inlet pipe at rear		24" (609.6mm)		132 lbs (60 kgs)
NGHP-6	6		150,000		36" (914.4mm)			36" (914.4mm)		198 lbs (90 kgs)



**winco**  
**SPECTRUM**  
 COUNTERTOP GAS CHARBROILERS

**COUNTERTOP GAS CHARBROILERS, NATURAL / LP**

The durable Spectrum stainless steel charbroilers feature a cool-touch front plate rail that runs the full length. These units are equipped with infinite heat controls, high-performance burners, heavy-duty cast iron top grates, and removable grease tray(s).

**NEW**



NGCB-24R

**NEW**



NGCB-36R

**NEW**



NGCB-48R

- ◆ High performance burners, each with output of 35,000 BTU/H
- ◆ Infinite heat controls
- ◆ Stainless steel 10 gauge radiant burner covers; field-convertible briquette rock kits sold separately
- ◆ Stainless steel insulated double-wall body, adjustable legs 4" to 6" and grease tray; non-skid feet
- ◆ Heavy-duty reversible cast iron grate, adjusts to three (3) height positions
- ◆ 5" cool-touch stainless steel front plate rail provides safety and knob protection
- ◆ 3-1/2" full-width grease trough
- ◆ Standing pilot ignition system, one per burner
- ◆ 3/4" rear gas connection with regulator
- ◆ Conversion kit allows the use of propane or natural gas
- ◆ One year parts and labor warranty

ITEM	DESCRIPTION	UOM	CASE
NGCB-24R	24" Gas Broiler, 2 Burners	Set	1
NGCB-36R	36" Gas Broiler, 3 Burners	Set	1
NGCB-48R	48" Gas Broiler, 4 Burners	Set	1
NG-Knob	Replacement Metal Knob	Each	1



MODEL	# OF BURNERS	BTU/BURNER	TOTAL BTU/HR	PRESSURE IN. W.C.	DIMENSIONS			GRATE SURFACE		SHIP WEIGHT
					LENGTH	DEPTH	HEIGHT	LENGTH	DEPTH	
NGCB-24R	2	35,000	70,000	4" / 10"	24" (609.6mm)	34-7/16" (874.7mm)	15-1/2" (393.7mm)	24" (609.6mm)	20" (508mm)	154 lbs (70 kg)
NGCB-36R	3		105,000		36" (914.4mm)	includes gas inlet pipe at rear		36" (914.4mm)		220 lbs (100 kg)
NGCB-48R	4		140,000		48" (1219.2mm)			48" (1219.2mm)		277 lbs (126 kg)



NGCB-P11-2/3/4



NGCB-P7

**GAS CHARBROILER ACCESSORIES - FIELD CONVERTIBLE**

ITEM	DESCRIPTION	UOM	CASE
NGCB-P11-2	24" Briquette Rock Kit	Pack	1
NGCB-P11-3	36" Briquette Rock Kit	Pack	1
NGCB-P11-4	48" Briquette Rock Kit	Pack	1
NGCB-P7	Replacement Briquettes (24/bag)	Bag	1



## COUNTERTOP GAS GRIDDLES, NATURAL / LP

Spectrum griddles are designed with durable stainless steel construction and cool-touch front plate rail that runs the full length. These units are equipped with infinite heat controls, high-performance burners, and removable grease drawer.

- ◆ High performance burners, each with output of 30,000 BTUH
- ◆ Infinite heat controls
- ◆ 5" wide cool-touch stainless steel front plate rail provides safety and knob protection
- ◆ Stainless steel insulated double-wall body, adjustable legs 4" to 6" and grease drawer with weep hole and baffle; non-skid feet
- ◆ 3/4" polished steel griddle plate with side and back splash guard
- ◆ 3-1/2" full width grease trough
- ◆ Standing pilot ignition system, one per burner
- ◆ 3/4" rear gas connection with regulator
- ◆ Conversion kit allows the use of propane or natural gas
- ◆ One year parts and labor warranty

ITEM	DESCRIPTION	UOM	CASE
NGGD-24M	24" Gas Griddle, 2 Heat Zones	Set	1
NGGD-36M	36" Gas Griddle, 3 Heat Zones	Set	1
NGGD-48M	48" Gas Griddle, 4 Heat Zones	Set	1
NG-Knob	Replacement Metal Knob	Each	1

# winco® SPECTRUM™ COUNTERTOP GAS GRIDDLES



NGGD-24M



NGGD-36M



NGGD-48M



ITEM	# OF BURNERS	TOTAL BTU/HR	PRESSURE IN. W.C.	DIMENSIONS			GRIDDLE SURFACE		SHIP WEIGHT
				LENGTH	DEPTH	HEIGHT	LENGTH	DEPTH	
NGGD-24M	2	60,000	4" / 10"	24" (609.6mm)	34-7/16" (87.3mm)	15-1/2" (393.7mm)	24" (609.6mm)	20-3/4" (527mm)	196 lbs (89 kg)
NGGD-36M	3	90,000		36" (914.4mm)	includes gas inlet pipe at rear		36" (914.4mm)		284 lbs (129 kg)
NGGD-48M	4	120,000		48" (1219.2mm)			48" (1219.2mm)		355 lbs (161 kg)



SANITATION



NGGD-SERIES



DINNERWARE	18
FLATWARE	46
BUFFET SERVICE	64
TABLETOP	82
DINING SERVICE	100
BEVERAGE SERVICE	124

DISPLAY	134
BAR SUPPLIES	140
APPAREL	158
PRO. CUTLERY	169
PRO. COOKWARE	197
STEAM TABLE PANS	224

POLY PANS/STORAGE	231
BAKEWARE	238
PIZZA SUPPLIES	265
FOOD PREP	274
KITCHEN UTENSILS	296
JANITORIAL	335

SHELVING & RACKS	355
BUSSING/TRANSPORT	360
COUNTERTOP EQUIPMENT	372
APPAREL SIZING	416

**Index by ITEM NUMBER**  
**Red indicates NEW item**

**0-9**

0001	60
0002	60
0004	59
0005	55
0006	54
0007	56
0008	57
0010	56
0012	60
0014	60
0015	55, 63
0016	57
0019	58
0021	54
0024	59
0025	59
0026	58
0030	46, 54, 63, 79
0031	47
0033	53
0034	51, 63
0035	52
0036	50
0037	49
0039	48
0081	61
0082	61
0083	61
101, 101A, 101B	64
103, 103A, 103B	64
108A	65
201	67
202	67
203	67
207	70
211	70
308A	65
408	67
508	67
601	66
602	64-66
603	66
708	67
901	75, 125
902	75, 125
903A, 903B	74, 124
904	75, 125
905A, 905B	74, 124
908	74, 124

**A**

AAD	327
AASP	248
ABBC	369
ABPN	247
ACN	137

ACP	246, 249
ACS	193
ACSD	112, 141
ACTD	112
ADB	138, 226-227
ADBC	333
ADC	136
ADD	257, 272
ADO	90
ADP	229
ADRG	259, 269
ADRK	358
AES	329
AFD	352
AFP	213, 216, 296
AFPI	212
AGP	218
AHC	333
AICD	304
ALBC	369
ALBP	217
ALCR	359
ALDP	256, 270
ALHP	216
ALO	285
ALPC	216
ALPR	243, 267, 363
ALRC	241-245, 267, 361-363, 365, 369
ALRK	241, 244, 245, 361, 363, 365
ALRP	217
ALRS	242, 362
ALSB	219
ALSP	223
ALXN	238
ALXP	106, 217, 238, 396
ALZK	242, 362
AM	264, 315
AMF	250
AMT	330
AP	127, 283
APCD	258, 286
APL	90
APM	249
APP	268, 332
APPL	249
APRK	126
APS	219
APSK	127
APSP	127
APZC	265
APZK	265
APZS	266
APZT	265-266
ARP	257, 272
AS	324
ASDR	358
ASFB	324
ASFP	219
ASFT	97, 110, 135

ASP	212, 218
ASS	318
AST	137
ATC	111
ATCH	101
AWPR	243, 267, 363
AWRC	240, 245, 360, 365
AWRK	240-241, 360-361
AWRS	242, 362
AWZK	242, 362
AXAP	215
AXBZ	215
AXHA	214
AXHB	214
AXHH	214
AXPE	239
AXS	212, 214-215
AXSI	212
AXST	215
AXTI	212

**B**

BA	114-115, 162-164, 166, 346
BADN	114, 163
BAM	229
BAMC	229
BAMN	228, 300
BAW	166, 346
BC	140
BCH	144
BCS	95
BFM	296
BGDV	118, 273, 369
BGPZ	118, 273, 369
BGS	108, 282
BHKF	307
BHKP	307
BHKS	307
BHON	303
BHOP	307
BHPN	303
BHPP	307
BHSN	303
BHSP	307
BL	142, 155
BLS	143
BM	155
BML	155
BPS	143
BR	133, 273, 349-351, 353
BRAF	343
BRAU	343
BRB	292, 348
BRC	348
BRF	343
BRFC	343
BRFF	343
BRH	343
BRM	118, 343

BRN	219, 348-349
BRP	219, 349
BRV	292, 348
BS	130, 142
BSFK	307
BSOB	307
BSON	303
BSOT	307
BSPB	307
BSPN	303
BSPT	307
BSSB	307
BSSN	303
BSST	307
BST	143
BTGP	156, 347
BTH	156, 347
BTM	156, 347
BTW	156, 347
BW	78
BXC	346

**C**

C-1080	69
C-2080B	68
C-2F, -3F	71
C-3080B	68
C-4080	69
C-5080	66
CAGP	209
CASD	209
CASM	82
CAST	82, 209
CB	292
CBBN	293
CBBU	293
CBEL	111
CBF	293
CBGR	293
CBH	292
CBI	292
CBK	291
CBM	275, 373
CBN	145, 290, 296
CBPP	296
CBR	293, 349
CBRD	293
CBS	151
CBST	293
CBWT	145, 292
CBXH	292
CBYL	293
CC	254
CCB	319
CCH	140
CCK	117
CCM	378
CCOD	285
CCP	248



KCP.....193  
 KCS.....109, 193  
 KDB.....85  
 KFP.....170-173, 184, 187, 332  
 KGD.....188  
 KPF.....233, 332  
 KPP.....192, 268  
 KPR.....185  
 KR.....188  
 KS.....186, 328

**KSP.....182-183**  
**KSTK.....174-175, 192, 268**  
**KWP.....176-181, 297, 310**

**L**

LC.....110, 329, 331  
 LDC.....297, 305  
 LDCN.....301  
 LDI.....305  
 LDIN.....301  
 LDT.....305  
 LE.....79  
 LED.....121  
 LMD.....100  
 LMF.....100  
 LMS.....100  
 LMTD.....100  
 LMTT.....100  
 LS.....146, 327

**M**

MAS.....113, 156  
 MB.....123, 139, 327  
 MBAF.....123, 139  
 MBB.....123, 139  
 MBBE.....123, 139  
 MBM.....123, 139  
 MBPM.....123, 139  
 MCP.....142, 264, 315  
 MCPP.....264, 314  
 MDL.....281  
 MH.....76, 102  
 MHH.....344  
 MMB.....38-39  
 MMPO.....38  
 MMPR.....38  
 MMPT.....38  
 MMSC.....39  
 MMU.....39  
 MOP.....341  
 MOPH.....341  
**MOPM.....341**  
**MOPR.....341**  
**MPB.....340**  
 MPD.....263, 271, 312  
 MPF.....223, 318  
 MPN.....223, 318  
 MPS.....146, 283  
 MS2K.....143, 259, 321  
 MS3A.....321  
 MSB.....320  
 MSBW.....321  
 MSH.....321  
 MSL.....264, 314  
 MSP.....264, 314  
 MSPD.....264, 314  
 MSPP.....264, 314

MSS.....320  
 MST.....321  
 MSTF.....321  
 MT.....330  
 MWP.....310  
 MXB.....284  
 MXBH.....284  
 MXBS.....284  
 MXBT.....284  
 MXHV.....284  
 MXRU.....284

**N**

NACP.....248  
 NB.....260  
 NC.....311  
 NG.....404-407  
**NGCB.....406**  
**NGGD.....407**  
**NGHP.....405**  
 NGSP.....404  
 NH.....112  
 NLG.....345  
 NLGH.....345  
 NPM.....283  
 NS.....263, 312  
 NSP.....263, 312  
 NTHM.....248

**O**

OC.....322  
 ODR.....111  
 OGZ.....118, 366  
 OM.....260  
 OMF.....261  
**OMNP.....261**  
 OMS.....261  
 OMT.....261  
 OP.....156, 354  
 OPL.....90, 105  
 OS.....276, 374

**P**

PBB.....97, 135  
 PBC.....253  
 PBD.....125  
 PBDW.....126, 236  
 PBM.....146  
 PBST.....260, 322  
 PC.....151  
 PCB.....118, 366  
 PCM.....249  
 PCRC.....233  
 PCSC.....232  
 PDG.....259, 269  
 PDS.....256, 271, 296  
 PDT.....131  
 PECC.....232, 296  
 PESK.....232  
 PF.....258, 322, 354  
 PFB.....99, 107  
 PFBT.....152  
 PFFW.....234  
 PFHW.....234  
**PFSF.....234**  
 PFSH.....234

PGS.....393  
 PGW.....227, 239  
 PGWS.....227, 239  
**PH.....205, 216, 261**  
**PJC.....346**  
**PK.....107, 141**  
 PKT.....152  
 PKTS.....94, 108, 280  
 PL.....118, 237, 256, 270, 366-367  
 PLB.....99, 107  
 PLK.....328  
 PLP.....367  
 PLTC.....367  
 PLW.....367  
 PMB.....188  
 PMC.....101  
 PMCD.....101  
 PMCF.....101  
 PMCP.....264, 315  
 PMCT.....101  
 PMG.....185, 331  
 PMP.....91  
 PMSB.....91  
 PMU.....264, 315  
 PN.....310  
 POA.....328, 354  
 POB.....99, 107  
**POP.....379**  
 PP.....150-151  
 PPA.....150  
 PPB.....152  
 PPC.....192, 257, 268  
 PPG.....267  
 PPH.....95  
 PPL.....347  
**PPM.....111, 151**  
 PPR.....150  
 PPRC.....233  
 PPT.....81, 308  
 PR.....93, 310  
 PRTS.....109, 193, 326  
 PS.....148, 324  
 PSB.....108, 323  
 PSBW.....97, 135  
 PSC.....262, 313  
 PSD.....262, 313  
 PSG.....262, 313  
 PSGE.....262, 313  
 PSH.....262, 296, 313  
 PSM.....330  
 PSN.....94  
**PSR.....346**  
 PST.....257  
 PSTCO.....257  
 PSUD.....95, 322  
 PSW.....108, 323  
 PT.....80, 309  
**PTC.....336-337**  
 PTCB.....336  
**PTCL.....336-337**  
 PTCP.....336  
**PTCR.....339**  
**PTCS.....339**  
**PTCSB.....339**  
**PTCSL.....339**  
**PTCSP.....339**  
 PTK.....299  
 PTM.....310  
 PTMP.....310

PTOS.....80, 309  
 PTP.....131  
 PTRC.....233  
 PTS.....86  
 PTSC.....232  
 PTSN.....131  
**PTW.....91**  
 PUTF.....81, 308  
 PWBK.....98  
 PWBK.....98, 138  
 PWC.....192, 268  
**PWR.....336**  
 PZG.....269  
 PZP.....267

**R**

RBM.....335  
 RBMH.....335  
 RBMI.....335  
 RC.....402  
 RD.....257, 272  
 RFM.....39, 94  
 RFS.....258, 272  
 RP.....39, 94  
 RS.....96  
 RSB.....354  
 RVS.....111  
 RW.....403

**S**

SAP.....205  
 SAS.....113, 156  
 SB.....261, 311  
 SBD.....128  
 SBF.....247  
 SBM.....146  
 SBMW.....88  
 SBR.....96  
 SBS.....239, 296  
 SBW.....96, 110  
 SC.....320  
 SCAL.....280  
 SCB.....118, 366  
 SCC.....327  
 SCD.....133  
 SCF.....320  
 SCLH.....280  
 SCP.....94  
 SCPH.....112  
 SCRCP.....351  
 SCS.....320  
 SCT.....95  
 SCU.....249  
 SD.....96, 352  
 SDA.....331  
 SDC.....252  
 SDP.....112, 141  
 SES.....329  
 SF.....258, 286, 322, 354  
 SFC.....86  
 SFCW.....86  
 SFR.....97, 110, 135  
 SFSG.....222  
**SGN.....76, 120-122, 128**  
 SGNB.....121  
 SHHD.....305  
 SIK.....354

SIV.....	258	ST.....	80, 309	TWPO.....	191, 252, 297, 317	WDP001.....	23
SIZ.....	90	STB.....	130	TWPS.....	191, 252, 297, 317	WDP002.....	23
SK.....	62, 194	STH.....	80, 309			WDP003.....	22
SKO.....	330	STN.....	286, 332	<b>U</b>		WDP004.....	19
SLO.....	285	STR.....	251	UC.....	368	WDP005.....	21
SMT.....	106	STRS.....	105, 154	UCF.....	368	WDP006.....	21
SND.....	96, 110	STS.....	79	UNF.....	158-162	WDP007.....	21
SP.....	89, 348	SUC.....	368	UP.....	286	WDP008.....	22
SP7 Series.....	231	SVM.....	282	UPP.....	347	WDP009.....	20
SPB.....	76, 124	SWA.....	330	USF.....	353	WDP010.....	20
SPBR.....	286, 323	SWS.....	330	UT.....	306, 309	WDP011.....	20
SPC.....	205, 327	SWU.....	90	UTLK.....	309	WDP012.....	26
SPCF.....	226			UTPH.....	296, 306	WDP013.....	25
SPCH.....	226	<b>T</b>		UTS.....	309	WDP014.....	27
SPCN.....	226	T.....	96			WDP015.....	27
SPCQ.....	226	TB.....	221	<b>V</b>		WDP016.....	27
SPCS.....	226	TBC.....	117	VC.....	356, 358	WDP017.....	24-25
SPCT.....	226	TBCO.....	117	VCB.....	356	WDP018.....	25
SPCTT.....	226	TBCS.....	117	VCCD.....	355	WDP019.....	22
SPF1.....	224	TBH.....	102	VCH.....	355	WDP020.....	25
SPF2.....	64-69, 224-225	TBN.....	102	VCS.....	355	WDP021.....	26
SPF4, SPF6.....	224	TCD.....	76, 102, 338	VEX.....	357	WDP022.....	19
SPFB.....	227	TCHS.....	86	VEXB.....	357	WDP023.....	23
SPFD.....	64-66, 225	TCK.....	104, 154	VEXS.....	355	WFB.....	260
SPFD2.....	225	TCT.....	277, 375	VM.....	358	WG10.....	142
SPFP2, SPFP4, SPFP6.....	225	TD.....	352-353	VP.....	192-193, 268, 325, 329, 331	WH.....	92
SPG.....	348	TFG.....	104, 154	VSS.....	129	WHW.....	324, 345
SPH1.....	224	TGAP.....	199	VSW.....	129	WKCS.....	210
SPH2, SPH4, SPH6.....	224	TGBZ.....	202	VTS.....	282	WKR.....	210
SPHP2, SPHP4, SPHP6.....	225	TGET.....	200			WLC.....	249
SPJH.....	224-225	TGFP.....	198	<b>W</b>		WMB.....	188
SPJL.....	224-226	TGSP.....	201	W612.....	130	WMW.....	146
SPJM.....	224	TIM.....	263	W632.....	130	WOK.....	210
SPJP.....	224	TKP.....	191, 269, 317	W670.....	130	WP.....	132
SPM.....	255, 298	TKPO.....	191, 252, 317	WA.....	116, 165	WPB.....	130
SPN2, SPN4.....	224	TKPS.....	191, 252, 317	WA4.....	116, 165	WPC.....	131
SPP.....	266	TLC.....	277, 375	WB.....	103, 153	WPCB.....	131
SPQ2, SPQ4, SPQ6.....	224	TMT.....	287-289	WBKG.....	99	WPCT.....	131
SPR.....	152	TN165.....	190, 316	WBKH.....	86, 92	WPE.....	132
SPS.....	299	TN166.....	190, 316	WBR.....	260	WPG.....	130
SPS2, SPS4, SPS6.....	224	TN249.....	190, 316	WBRP.....	260	WPIT.....	131
SPSCF.....	226	TN32.....	190, 316	WBS.....	151	WPM.....	89
SPSCH.....	226	TN409.....	190, 316	WCB.....	103, 153	WPMP.....	89
SPSCN.....	226	TN43.....	190, 316	WCH.....	117	WPP.....	268
SPSCQ.....	226	TN44.....	190, 316	WCS.....	340	WPS.....	131
SPSCS.....	226	TN46.....	190, 316	WDL001.....	37	WPST.....	319
SPSCT.....	226	TN48.....	190, 316	WDM001.....	29	WR.....	339
SPSCTT.....	226	TN526.....	190, 316	WDM002.....	37	WRP.....	257, 272
SPT2, SPT4, SPT6.....	224	TN54.....	190, 316	WDM003.....	35	WS.....	345
SPTT2, SPTT4, SPTT6.....	224	TN56.....	190, 316	WDM004.....	36	WSK.....	330
SQG.....	326	TN713.....	190, 316	WDM005.....	35	WSP.....	263, 312
SR.....	403	TN719.....	190, 316	WDM006.....	37	WSS.....	345
SRK.....	230, 243, 245, 364-365	TNH.....	190, 316	WDM007.....	36	WWB.....	97
SRS.....	61, 79, 327	TNS.....	190, 252, 316	WDM008.....	30	WWP.....	263, 312
SRT.....	329	TOS.....	190, 252, 316	WDM009.....	34		
SS.....	184	TP353.....		WDM010.....	37	<b>X</b>	
SSBD.....	126	TR104.....	91, 283	WDM011.....	31	XLB.....	147, 381
SSC.....	324	TRH.....	104, 154	WDM012.....	33		
SSD.....	259	TSC.....	327, 353	WDM013.....	34	<b>Z</b>	
SSDB.....	206	TSY.....	104	WDM014.....	33	Z-AR.....	45
SSET.....	203	TT 111.....		WDM015.....	31	Z-AZ.....	42
SSFP.....	204	TTG.....	299	WDM016.....	31	Z-CL.....	43
SSLB.....	203	TTG5.....	331	WDM017.....	30	Z-CR.....	44
SSOP.....	73, 204	TTH.....	353	WDM018.....	32	Z-IS.....	41
SSS.....	318	TTS.....	276, 374	WDM019.....	32	Z-MC.....	40
SSSP.....	203	TW.....	113	WDM020.....	28		
SST.....	203	TWP.....	179, 191, 297, 317				
SSTC.....	203-204, 206						
SSTW.....	141						

DINNERWARE	18
FLATWARE	46
BUFFET SERVICE	64
TABLETOP	82
DINING SERVICE	100
BEVERAGE SERVICE	124

DISPLAY	134
BAR SUPPLIES	140
APPAREL	158
PRO. CUTLERY	169
PRO. COOKWARE	197
STEAM TABLE PANS	224

POLY PANS/STORAGE	231
BAKEWARE	238
PIZZA SUPPLIES	265
FOOD PREP	274
KITCHEN UTENSILS	296
JANITORIAL	335

SHELVING & RACKS	355
BUSSING/TRANSPORT	360
COUNTERTOP EQUIPMENT	372
APPAREL SIZING	416

## Index by ITEM NAME

Red indicates NEW item

### A

ACCELMIX™	147, 381
ACERO .62, 170-173, 184, 186-187, 194, 328, 332	
Adaptor Bar	227
Adaptor Plate	229
Adaptor Plate, Cast Iron	401
Adaptor Ring	388
Adaptor, Display	138, 226
Air Freshener, Automatic	352
Airpot	127
Airpot Rack	126
Allergen-Free	216, 232, 239, 256, 262, 271, 290, 295-297, 313
Apple Corer	325
Apple Divider	327
Apple Peeler, Countertop	283
Apron, Bib	114-115, 162-164
Apron, Bistro	116, 165
Apron, Dishwashing	166, 346
Apron, Four-Way	116, 165
Apron, Latex	166, 346
Apron, Vinyl	166, 346
Apron, Waist	116, 165
Ardesia™	19-37
Ashtray	113, 156
Au Gratin Dish	90

### B

Backpack, Knife	189
Bag, Delivery	118, 273, 369
Bag, Janitorial	338
Bag, Knife	189
Bagel Slicer	108, 282
Baguette Pan	246-247
Bain Maries	228-229, 300
Baking Mats, Silicone	239, 296
Baking Pan	217
Bar Liners	155
Bar Mats	155
Bar Shakers & Cups	142
Basket, Breacing	321
Basket, Culinary	320
Basket, Doughnut	251
Basket, Fast Food	99, 107
Basket, Flatware	118, 366
Basket, Fryer	221, 223
Basket, Pasta	223, 318
Basket, Plastic	99, 107
Basket, Serving, Mini	86
Basket, Serving, Wire	99
Basket, Steamer, S/S	219
Basket, Woven	98, 138
Baster	260, 322
Basting Fork, Nylon	311
Basting Fork, S/S	307
Basting Spoon, S/S	303, 307
Batter Dispenser	258, 286
Beer Mug Washer	156, 349
Bell, Call	111
Beverage Dispenser	74-75, 124-126, 236

Beverage Dispenser, Insulated	128
Beverage Display, Electric	382
Beverage Server, Insulated	129
Beverage Server, S/S	130
Bin, Flatware & Cutlery	118, 366
Bin, Ingredient	235, 369
Bin, Ingredient, Shelf	235

Blade Station™	182
Blender, Electric	147, 381
Blender, Pastry	257
Blini Pan	85
Board, Marker	123, 139
Board, Serving	88, 109, 294
Booster Seat	119
Bottle Cap Catch	144
Bottle Opener	144-145
Bottle Stopper	151
Bottle, Flair	152
Bottle, Spray	346
Bottle, Squeeze	108, 323
Bowl, ABS	97, 135
Bowl, Display	134
Bowl, Kady	85
Bowl, Mixing	284
Bowl, PC	97, 135
Bowl, Punch	76, 124
Bowl, Salad	97, 135
Bowl, Salsa	91
Bowl, Sugar	96
Bowl, Wood	97
Box Cutter	346
Brazier, Alu	214-215
Brazier, S/S	202-203
Bread Board	88, 109, 294
Bread Form, Silicone	247
Briquette Rocks	406
Broom Heads & Handles	343
Broom, Lobby	118
Brush, Basting	260
Brush, Bottle	292, 348
Brush, Broiler	350
Brush, Butcher Block	350
Brush, Coffee Decanter	133, 349
Brush, Counter	348
Brush, Cutting Board	293, 349
Brush, Equipment	133, 349
Brush, Floor Scrub	343
Brush, Fyer	349
Brush, Glass	156, 349
Brush, Grill	350
Brush, Nail	348
Brush, Oven	350
Brush, Pastry	260
Brush, Pizza Oven	273, 350
Brush, Pot	219, 349
Brush, Scratch	351
Brush, Silicone	261, 311
Brush, Toilet	353
Brush, Utility, Mini	351
Brush, Vegetable	292, 348
Bucket, Cleaning	347
Bulb, Heat Lamp	391
Bulk Knives, Pairing	178
Bulk Knives, Sandwich Spreader	179, 317
Bus Box & Cover	367
Bus Box Cart	369
Butane Gas Stove	393
Butter Curler	325
Butter Roller	286, 323
Butter Warmer	96, 110

### C

Caddy, Bar	140
Caddy, Dish	366
Caddy, Janitorial	338, 346
Caddy, Tabletop	92
Cadenza™	40-45
Cake Decorating Comb	252
Cake Decorating Tips	253

Cake Leveler, Wire	249
Cake Marker	247, 249
Cake Pan	246, 248-249
Cake Stand & Cover	136, 252
Call Bell	111
Can Opener, Counter Mount	274, 372
Can Opener, Handheld	145, 329
Can Storage Rack	359
Can Tapper	145
Carafe, Insulated	129
Cart, Bus Box	369
Cart, Cotton Candy Machine	378
Cart, Lug Box	369
Cart, Popcorn Machine	379
Cart, Trash Can	336
Cart, Utility	368
Carving Board, Wood	294
Casserole, Mini	83-84
Cast Iron Cookware	209
Cast Iron Cookware, Mini	82
Caster, Sheet Pan Rack	245, 365
Caster, Universal	245, 360
Chafer	64-69
Chafer Fuel Can	70
Chafer Stand, Wire	71
Chair, High	119
Charbroiler, Gas	406
Check Service	111
Cheese Board	88, 109, 294
Cheese Grater	109, 193, 325-326
Cheese Knife	193
Cheese Knife Set	109, 193
Cheese Plane	193, 325
Cheese Slicer, Countertop	277, 375
Cheese Slicer, Handheld	193
Cheese Slicer, Wire	193, 328
Chef Hat	166-167
Chef Jacket	158-159
Chef Pants	161-162
Chef Shirt	160
Cherry Corer	327
Chinois Pesto	319
Chopper/Dicer	282
Chopper/Dicer, Countertop	278, 376
Cleaver	187
Coat Check Tickets	117
Coat Hangers	117
Cocktail Picks	107, 141
Cocktail Shaker	142
Coffee Accessories	133
Coffee Decanter	133
Coffee Infuser	87, 133
Coffee Press, French	87, 132
Coffee Server, Insulated	129
Coffee Server, S/S	130, 132
Coffee Urn	74, 124
Coffee Urn, Electric	385
Coffee Warmer, Electric	132, 384
Colander	285
Colander, Food Storage Box	234
Colander, Mini	85
Colander, Scoop	319
Condiment Caddy & Holder, Bar	140
Condiment Caddy & Holder, Tabletop	92
Condiment Dispenser, S/S94, 108, 280	
Condiment Jar & Covers	96
Condiment Packet Holder, S/S	112
Connoisseur	223, 257, 318
Convection Oven	396
Conveyor Toaster	398
Cookie Cutter	254
Cookie Sheet	251

Cooking Tools, Nylon	311
Cookware Set, S/S	205
Cookware, Cast Iron, Mini	82
Cookware, Mini	83-85
COOL HEAT Turners	190, 316
Corer, Apple	325
Corer, Cherry	327
Corer, Pineapple	327
Corer, Tomato	325, 327
Corkscrew	144
Cotton Candy Machine	378
Cover, Bain Marie	228-229, 300
Cover, Basting	333
Cover, Cookware, Alu	212, 214-216, 218
Cover, Cookware, S/S	203-204, 206
Cover, Display, PC	137, 231
Cover, Display, S/S	138, 226
Cover, Food Pan, PC	231
Cover, Food Storage Box	234
Cover, Food Storage Container	232-233, 236, 296
Cover, Inset	228-229, 300
Cover, Sheet Pan	239
Cover, Sheet Pan Rack	245, 365
Cover, Steam Table Pan	226
Cover, Wok	208
Creamer Server, Insulated	129
Creamer, S/S	95
Crock, Deli	135, 236
Cruet, Oil & Vinegar	92
Cup Dipensers, Racks, & Organizers	133
CURV™	81, 308
Cutlery Bin	118, 366
Cutting Board	145, 290-294, 296
Cutting Board Rack	292
Cutting Board, Wood	294
Cutting Mat	293

### D

Decanter, Coffee	133
Decanter, PC	131
Decorating Comb	252
Decorating Tips	253
Deep Fryer, Countertop	399
Deli Crock & Cover	135, 236
Dinnerware, Melamine	28-39
Dinnerware, Porcelain	19-27
Dinnerware, Slate	37
Dipper, Ice Cream	304
Dipper, S/S	305
Dish Box & Cover	367
Dish Caddy	366
Dish, Ice Cream & Berry	94
Dish, Sherbet	96
Dish, Snail	96, 110
Disher	297, 304
Dispenser, Batter	258, 286
Dispenser, Brick Packs	341
Dispenser, Condiment	94, 108, 280
Dispenser, Cup	133
Dispenser, Napkin	112
Dispenser, Paper Towel	352
Dispenser, Powder Sugar	259
Dispenser, Soap	352
Dispenser, Straw	112, 141
Dispenser, Syrup	95, 322
Dispenser, Toilet Seat Cover	353
Dispenser, Toilet Tissue	353
Dispenser, Toothpick	112
Dispenser, Whipped Cream	253, 281, 298

Display Adaptor ..... 138, 226  
 Display Bowl..... 134  
 Display Case, Acrylic..... 136  
 Display Riser ..... 77, 134  
 Display Tray, Acrylic..... 137  
 Display Tray, S/S..... 77, 134  
**Display, Heated Merchandiser..... 383-384**  
 Display, Refrigerated..... 382  
 Dolly, Dough Box ..... 237, 244, 270, 365  
 Dolly, Food Transporter..... 370  
 Dolly, Trash Can ..... 336-337  
 Dome Cover, PC ..... 137, 231  
 Double Boiler, S/S..... 206  
 Dough Box & Cover..... 237, 256, 270  
 Dough Box Dolly ..... 237, 244, 270, 365  
 Dough Divider..... 257, 272  
 Dough Pan & Cover..... 256, 270  
 Dough Roller Docker..... 257, 272  
 Dough Scraper ..... 256, 271, 296  
 Doughnut Cutter..... 254  
 Drain Shelf, PC..... 231, 234  
 Dredge..... 259, 269  
 Drinkware, Glass..... 142  
 Drinkware, Plastic..... 131  
 Drinkware, S/S..... 87, 142  
 Drip Trays..... 75, 128  
**Dump Station Pan Holder..... 390**  
 Dunnage Rack..... 358  
**Dust Mop..... 342**  
**Dust Pan..... 118, 344**  
**E**  
 Easel..... 123, 139  
 Egg Poacher..... 205  
 Egg Ring..... 333  
 Egg Separator ..... 329  
 Egg Slicer..... 329  
 Eraser, Marker Board ..... 123, 139  
 Extender, Sheet Pan ..... 239  
**F**  
 Fajita Server ..... 90, 208  
 False Bottom, S/S ..... 227  
 Filter, Fryer Stand..... 222, 333  
 Filter, Hood ..... 354  
**FireIron™..... 82, 209**  
 Fish Bone Tweezers..... 331  
 Fish Scaler, S/S..... 331  
 Fish Spatula..... 190-191, 297, 311, 316-317  
 Flair Bottle ..... 152  
**Flatware..... 41-63**  
 Flatware Cylinder & Organizer..... 118, 366  
**Floor Mat..... 335**  
**Floor Sweep Heads & Handles..... 343**  
 Food Cooker & Warmer, Electric..... 388-389  
 Food Marker, Bamboo ..... 296  
 Food Markers, Steak..... 330  
 Food Mill..... 282  
**Food Pan Rack..... 230, 243, 364**  
 Food Pan, Chafer..... 64-69, 225  
 Food Pan, PC..... 231  
 Food Storage Box..... 234  
 Food Storage Container..... 232-233, 236  
 Food Transporters, Insulated..... 370  
 Food Warmer, Electric ..... 388-389  
 Fork, Basting..... 307, 311  
 Fork, Cook's..... 172, 187, 332  
 Fork, Pasta..... 79, 311  
 Fork, Pot..... 233, 332  
 Fork, Serving, S/S..... 46, 78-79  
 Fork, Snail..... 96, 110  
 French Fry Bagger..... 222, 333  
 French Fry Cutter..... 279, 377  
 French Press..... 87, 132  
 Frothing Pitcher..... 132  
 Fruit & Vegetable Slicer..... 275, 373  
 Fruit Wedge Slicer, Countertop..... 278, 376  
 Fry Basket..... 221, 223  
 Fry Basket Divider ..... 220

Fry Basket Press..... 220  
 Fry Basket, Mini..... 86  
 Fry Cup..... 86  
 Fry Pan, Alu..... 212-213  
 Fry Pan, Carbon Steel..... 207  
 Fry Pan, Mini..... 83-84  
 Fry Pan, S/S..... 198, 204  
 Fry Server, Wire ..... 86  
 Fryer Filter Stand..... 222, 333  
 Fryer Pan, Alu..... 223  
 Fryer Screen..... 222, 333  
 Fryer Splash Guard..... 222  
 Fuel Holder..... 64-70  
 Funnel..... 258, 322, 354  
**G**  
 Garlic Press..... 329  
 Gladiator™ Fry Pans..... 213  
 Glass Hanger Rack..... 155  
 Glass Rimmer..... 143  
 Glasses, Drinkware..... 142  
**Glove Box Bracket..... 345**  
**Gloves, Cut Resistant..... 185**  
 Gloves, Latex..... 345  
 Gloves, Poly..... 345  
**Gloves, Protective Mesh..... 185, 331**  
 Gloves, Service..... 117, 164  
 Grapefruit Spoon..... 61, 327  
 Grate, Sheet Pan..... 239  
 Grate, Steam Table Pan..... 227  
 Grater..... 109, 325-326  
 Grater, Cheese..... 109, 193, 325-326  
 Gravy Boat..... 95  
**Griddle Plate, Cast Iron..... 401**  
 Griddle, Anodized Alu..... 210  
 Griddle, Cast Iron..... 210  
**Griddle, Electric..... 404**  
**Griddle, Gas..... 407**  
 Grill Cleaners..... 351  
**Grill Pan, Cast Iron..... 209**  
 Grill, Panini..... 401  
 Grill, Sandwich..... 400  
 Grinder, Salt & Pepper..... 89  
 Guest Check Holder..... 111  
 Gyro Pan..... 218  
**H**  
 Hamburger Press..... 330  
**Headwear..... 166-167**  
**Heat Lamp..... 391**  
**Heated Merchandiser Display..... 383-384**  
 High Chair..... 119  
 Hollowware, Stainless Steel..... 40  
 Hood Filter..... 354  
 Hook, Pot..... 205  
 Hook, Shelving..... 356-357  
**Hot Dog Roller Grill..... 380**  
**Hot Plate, Gas..... 405**  
 Hottle, Glass..... 130  
**I**  
 Ice Bucket..... 153  
 Ice Caddy, Insulated..... 149, 370  
 Ice Chipper..... 148  
 Ice Cream Cone Holder..... 137  
 Ice Cream Scoop..... 304  
 Ice Cream Spade..... 304  
 Ice Crusher..... 149  
 Ice Cube Tray..... 148  
 ICE ONLY Container..... 149  
 Ice Pick..... 148  
 Ice Scoop..... 148, 324  
 Ice Tongs..... 148  
**Immersion Circulator..... 394**  
**Induction Cooker..... 72-73, 392-393**  
 Ingredient Bin..... 235, 369  
 Ingredient Bin, Shelf..... 235  
 Insets..... 70, 228-229, 300, 388  
**J**  
**Jacket, Chef..... 158-159**  
 Jigger..... 143

**Juice Dispenser..... 74-75, 124-125**  
 Juice Pour Bottle..... 152  
 Juicer, Citrus..... 146, 327  
 Juicer, Countertop..... 146, 283  
**K**  
 Kady Bowl..... 85  
**KATTEX™..... 275-279, 373-377**  
 Knife Bag..... 189  
 Knife Bag Set..... 173, 179  
 Knife Block Set..... 173  
 Knife Guard..... 188  
 Knife Holder, Magnetic..... 188  
 Knife Rack..... 188  
**Knife Sharpener..... 182-183**  
 Knife, Boning..... 170, 174, 176, 180  
 Knife, Bread, 172, 174, 176, 178, 181, 297  
**Knife, Breaking..... 177**  
**Knife, Butcher..... 178**  
 Knife, Carving..... 78  
 Knife, Cheese..... 109, 193  
 Knife, Chef's..... 171, 175, 177, 181, 297  
 Knife, Chopping..... 192  
 Knife, Cimeter..... 175, 177  
 Knife, Fillet..... 172, 174  
 Knife, Lettuce..... 328  
 Knife, Mezzaluna..... 192  
 Knife, Nakiri..... 170  
 Knife, Oyster..... 192, 325, 331  
 Knife, Paring..... 170, 174, 176, 178, 180, 185, 297  
 Knife, Pastry..... 174  
 Knife, Peeling..... 170  
 Knife, Pizza..... 192, 268  
 Knife, Santoku..... 170, 175, 177, 181  
 Knife, Slicer..... 78, 172, 175, 178  
 Knife, Steak..... 62-63, 194-195  
 Knife, Tomato..... 170  
 Knife, Utility..... 170, 174, 176, 185  
**L**  
 Ladle, Mini..... 264, 314  
 Ladle, Nylon..... 311  
 Ladle, S/S..... 297, 301, 305  
 Ladle, Serving S/S..... 78-79  
 Ladle, Serving, PC..... 81, 308  
 LED Sign..... 121  
 Lettuce Cutter, Countertop..... 277, 375  
 Lettuce Knife..... 328  
 Liner, Bar..... 155  
 Liquor Pour Bottle..... 152  
 Liquor Pourer..... 150-151  
**Liquor Pourer, Over-Sized..... 151**  
**Loaf Pan..... 246, 250**  
 Lobster Cracker..... 110, 331  
 Lug Box..... 367  
 Lug Box Cart..... 369  
**M**  
 Maestro™..... 89  
 Majestic™ Fry Pans..... 213  
 Mandoline Slicers..... 281  
 Marker Board..... 123, 139  
 Marker, Cake..... 247, 249  
 Marker, Neon..... 123, 139  
 Masher..... 310-311  
 Mat, Bar..... 155  
**Mat, Floor..... 335**  
 Mat, Shelving..... 358  
 Measuring Cups..... 264, 314-315  
 Measuring Spoons..... 264, 314  
 Meat Tenderizer..... 330  
 Melamine Dinnerware..... 28-39  
 Melon Baller..... 325, 327  
 Menu Cover..... 100-101  
 Menu Holder Clips..... 76, 102  
 Menu Stand, Acrylic..... 101  
 Menu Tent..... 100  
**Merchandiser Display, Heated..... 383-384**  
 Microwave..... 397  
 Milk Can, Mini..... 87

Mint Julep Cup..... 87, 142  
**Mitt, Oven..... 261**  
 Mixing Bowl..... 284  
 Mixing Bowl Stand..... 284  
 Mixing Paddle..... 263, 271, 312  
 Mold, Pastry..... 255, 298  
**Mop Bucket..... 340**  
 Mop Handle..... 341  
**Mop Head, Dust..... 342**  
**Mop Head, Wet..... 341**  
 Mortar & Pestle..... 146, 283  
 Moscow Mule Mug..... 87, 142  
 Muddler..... 146  
 Muffin Pan..... 250  
**N**  
 Napkin Dispenser..... 112  
 Nut Cracker..... 110, 329, 331  
**O**  
 Oil & Vinegar Cruets..... 92  
 Oil Can..... 322  
 Oil Mop..... 260  
 Omelet Pan..... 73, 204  
 Onion Slicer, Countertop..... 276, 374  
 Order Rack..... 111  
 Organizer, Cup & Lid..... 133  
**Oven Mitt..... 261**  
 Oven, Convection..... 396  
 Oven, Pizza..... 396  
**P**  
 Paella Pan..... 207  
 Pail Opener..... 328, 354  
 Pail, Mini..... 87  
**Pail, Utility..... 286, 347**  
 Pan Grabber..... 216  
 Pan, Omelet..... 73, 204  
 Panini Grill..... 401  
**Pants, Chef..... 161-162**  
 Paper Towel Dispenser..... 352  
 Pasta Basket..... 223, 318  
 Pasta Cooker Set, S/S..... 219  
 Pasta Fork..... 79, 311  
 Pasta Maker..... 283  
 Pastry Bag..... 253  
 Pastry Blender..... 257  
 Pastry Brush..... 260  
 Pastry Cutter..... 254  
 Pastry Mold..... 255, 298  
 Pastry Wheel..... 257  
 Peeler, Apple, Countertop..... 283  
 Peeler, Vegetable..... 325, 329  
 Pen, Counterfeit Detection..... 111  
 Peppermill..... 89  
 Pestle, Chinois..... 319  
**Picks, Bamboo..... 107, 141**  
 Picks, Decorative..... 107, 141  
 Picks, Seafood..... 110, 331  
 Pie Cutter..... 249  
 Pie Pan..... 249  
 Pie Server..... 78, 190-191, 297, 316-317  
 Pineapple Corer..... 327  
 Pipe, Overflow..... 156, 354  
 Pitcher, Plastic..... 131  
 Pitcher, S/S..... 130  
 Pitcher, S/S, Frothing..... 132  
 Pitcher, Syrup/Cream..... 94  
 Pizza Bubble Popper..... 267  
**Pizza Cutters..... 192, 268, 325**  
 Pizza Knives..... 192, 268  
 Pizza Oven..... 396  
 Pizza Pans..... 265-266  
 Pizza Pan Grippers..... 267  
 Pizza Pan Rack..... 243, 266, 267, 363  
 Pizza Pan Stand, Tabletop..... 266  
 Pizza Peels..... 268, 332  
 Pizza Screens..... 266  
 Pizza Server..... 269  
 Pizza Serving Tongs..... 269  
 Plate, Salsa..... 91  
 Plating Tools..... 299

- Platter, Plastic ..... 99, 107  
 Platter, S/S ..... 90, 105  
 Platter, S/S, Mini ..... 88  
 Platter, Sizzling ..... 90  
 Plunger ..... 353  
**Popcorn Machine** ..... 379  
 Porcelain Dinnerware ..... 19-27  
 Portioner ..... 297, 302, 304-305  
**Pot Holder** ..... 261  
 Pot Hook ..... 205  
 Potato Ricer ..... 310  
 Pourer Bottle, Liquor & Juice ..... 152  
 Pourer Cover, Liquor ..... 151  
 Pourer, Liquor ..... 150-151  
**Pourer, Liquor, Over-Sized** ..... 151  
 Proofing Pan & Cover ..... 256, 270  
 Pullman Pan & Cover ..... 246  
 Pump Kit, Syrup & Liqueurs ..... 152  
 Punch Bowl ..... 76, 124
- Q**  
 Quiche Pans ..... 249
- R**  
**Rack, Can Storage** ..... 359  
 Rack, Cup ..... 133  
 Rack, Cutting Board ..... 292  
 Rack, Dunnage ..... 358  
 Rack, Glass Hanger ..... 155  
 Rack, Icing/Cooling ..... 251  
 Rack, Knife Storage ..... 188  
 Rack, Mop & Broom ..... 344  
 Rack, Order ..... 111  
 Rack, Pizza Pan ..... 243, 267, 363  
 Rack, Seafood ..... 97, 110, 135  
**Rack, Sheet Pan** ..... 360-363  
 Rack, Steamer ..... 251  
 Ramekins ..... 39, 94  
 Refrigerated Beverage Display ..... 382  
 Relish Server ..... 96  
 Restroom Necessities ..... 353  
 Rice Cooker ..... 402-403  
 Rice Cooker & Warmer ..... 402  
 Rice Warmer ..... 403  
 Riser, Display ..... 77, 134  
 Roasting Pan ..... 217  
 Roasting Pan, Mini ..... 85  
 Rolling Pin ..... 257, 272  
**Rollsright™** ..... 380  
 Roll-Top Cover, S/S ..... 138, 226
- S**  
 Salad Bowl ..... 97, 135  
 Salt & Pepper ..... 89, 93  
 Sandwich Grill ..... 400  
 Sandwich Spreader ..... 179, 190-191, 297, 316-317  
 Sauce Cup, S/S ..... 94  
 Sauce Pan, Alu. .... 218  
 Sauce Pan, Mini ..... 83-84  
 Sauce Pan, S/S ..... 199, 203, 205  
 Sauce Pot, Alu. .... 214-215  
 Saucier, Mini ..... 83  
 Sauté Pan, Alu. .... 212, 215  
 Sauté Pan, S/S ..... 200, 203  
 Scale, Digital ..... 280  
 Scale, Mechanical ..... 280  
 Scoop Holder ..... 324  
 Scoop, Alu. .... 324  
 Scoop, Coffee ..... 132  
 Scoop, Ice Cream ..... 304  
 Scoop, PC ..... 148, 324  
 Scoop, PP ..... 324  
 Scoop, S/S ..... 148, 324  
 Scouring Pad ..... 348  
 Scrap Block ..... 354  
 Scraper, Cooking ..... 190-191, 316-317  
 Scraper, Dough ..... 256, 271, 296  
 Scraper, Grill ..... 351  
 Scraper, Pizza Oven ..... 273, 350  
 Scraper, Plastic ..... 262, 313  
 Scraper, Silicone ..... 262, 296, 313
- Seafood Picks ..... 110, 331  
 Seafood Tray & Rack ..... 97, 110, 135  
 Serrator ..... 329  
**Server Book** ..... 111  
 Server, Coffee/Cream ..... 95, 129-130  
 Server, Relish ..... 96  
 Serving Board ..... 88, 109, 294  
 Serving Tray, Chrome Plated ..... 77  
 Serving Utensils, PC ..... 81, 308  
 Serving Utensils, S/S ..... 46, 78-80, 148, 309  
 Shaker, Bar ..... 142  
 Shaker, Glass ..... 93  
**Sharpener, Knife** ..... 182-183  
 Sharpening Guide ..... 184  
 Sharpening Steel ..... 173, 184  
 Sharpening Stone ..... 184  
 Shears ..... 186, 328  
 Sheet Pan Accessories ..... 239  
**Sheet Pan Rack** ..... 241, 244, 361, 363  
 Sheet Pan Rack Accessories ..... 245, 365  
 Sheet Pan Rack, Heavy-Duty ..... 240, 360  
 Sheet Pan Rack, Nesting ..... 242, 362  
 Sheet Pan Rack, Side-Load ..... 242, 362  
 Sheet Pan Truck ..... 244, 363  
**Sheet Pan, Alu.** ..... 217, 238, 396  
**Sheet Pan, Alu, Fully Perforated** ..... 238  
 Sheet Pan, Alu, Perforated ..... 238  
 Sheet Tray, Plastic ..... 238  
 Shelving Cart ..... 355  
 Shelving Parts & Accessories ..... 356-358  
 Shelving Sets ..... 355  
**Shirt, Chef** ..... 160  
 Shrimp Develiner ..... 331  
 Sieve, S/S ..... 258  
 Sifter ..... 143, 259  
 Sifter, Rotary ..... 258, 272  
 Sign, "Reserved" ..... 111  
 Sign, Beverage, S/S ..... 76, 128  
 Sign, Clip & Holders ..... 76, 102  
 Sign, Floor, Caution ..... 340  
 Sign, Hostess ..... 122  
**Sign, Information** ..... 120-121  
 Sign, Information, Braille ..... 121  
 Sign, Information, Spanish ..... 120  
 Sign, LED ..... 121  
 Sign, Stanchion ..... 122  
**SignatureChef™ Apparel** ..... 114-116, 158-165, 167  
 Sizzling Platter ..... 90  
 Skewers ..... 330  
**Skillet, Cast Iron** ..... 209  
 Skimmer, Nickel Plated ..... 320  
 Skimmer, Nylon ..... 311  
 Skimmer, S/S ..... 320  
 Slate Dinnerware ..... 37  
 Sleeve, Pan Handle ..... 208  
 Sleeve, Pan Handle, Silicone ..... 216, 296  
 Slicer, Bagel ..... 108, 282  
 Slicer, Egg ..... 329  
 Slicer, Mandoline ..... 281  
 Slicer, Turning ..... 282  
 Snail Service ..... 96, 110  
**Sneeze Guard, Hot Dog Grill** ..... 380  
 Soap Dispenser ..... 352  
**Sof-Tek™** ..... 174-175, 185, 192, 268  
 Soup Warmer ..... 70  
 Soup Warmer, Electric ..... 387  
**Sous Vide Equipment & Accessories** ..... 394-395  
 Spaghetti Server ..... 79  
 Spatula, Bakery ..... 190-191, 252, 297, 316-317  
 Spatula, Cooking ..... 190-191, 297, 316-317  
 Spatula, Cooking, Nylon ..... 311  
**Spectrum™** ..... 72-73, 392-395, 397-398, 404-407  
 Speed Rail ..... 152  
 Spillage Pan ..... 225  
**Sponges** ..... 348  
 Spoon, Bar ..... 143  
 Spoon, Buffet, PC ..... 81, 308  
 Spoon, Grapefruit ..... 61, 327  
 Spoon, Nylon ..... 263, 311-312  
 Spoon, Plating, S/S ..... 299
- Spoon, Serving, PC ..... 81, 308  
 Spoon, Serving, S/S ..... 46, 78-79  
 Spoon, Wood ..... 263, 312  
**Spray Bottle** ..... 346  
 Spreader, Sandwich ..... 179, 190-191, 297, 316-317  
 Springform Pan ..... 248  
 Squeezegee ..... 345  
 Squeeze Bottle ..... 108, 323  
 Squeezer, Citrus ..... 146, 283, 327  
 sTAbLEizer ..... 113  
**stÅL** ..... 176-181, 297  
 Stanchion Sign System ..... 122  
**STATIKBOARD™** ..... 145, 275, 290-291, 296, 373  
 Steak Knife ..... 62-63, 194-195  
 Steak Markers ..... 330  
 Steak Server ..... 90, 208  
**Steak Weight** ..... 330  
 Steam Table Pan ..... 224  
 Steam Table Pan Cover ..... 226  
 Steam Table Pan Grate ..... 227  
**Steam Table Pan Rack** ..... 230, 243, 364  
 Steam Table Pan, Half Long ..... 225  
 Steam Table Pan, Perforated ..... 225  
 Steamer Basket ..... 219  
 Steamer Rack ..... 251  
 Steamer Set, S/S ..... 206  
 Stir Fry Pan, Alu. .... 219  
 Stirring Paddle ..... 263, 312  
 Stock Pot, S/S ..... 201, 203  
 Storage Container ..... 232-233, 236  
 Stove, Butane Gas ..... 393  
 Stove, Stock Pot, Gas ..... 404  
 Strainer ..... 143, 259  
 Strainer, Bar ..... 143  
 Strainer, Bouillon ..... 319  
 Strainer, China Cap ..... 319  
 Strainer, Floor ..... 344  
 Strainer, Julep ..... 143  
 Strainer, S/S Mesh ..... 321  
 Strainer, Sink ..... 354  
 Strainer, Spaghetti ..... 318  
 Straw Dispenser ..... 112, 141  
 Straw, S/S ..... 141  
 Strip Heater ..... 390  
**Sub Sandwich Roll Pan** ..... 247  
 Sugar Bowl ..... 96  
 Sugar Can ..... 96  
 Sugar Packet Holder ..... 95  
 Sweeper, Rotary ..... 118, 344  
 Syrup Dispenser ..... 93, 95, 322  
 Syrup Pitcher ..... 94
- T**  
 Table Cloth ..... 117  
 Table Cloth Clip ..... 117  
 Table Crumber ..... 111  
 Table Numbers ..... 102  
 Table Sign Holders ..... 76, 102  
 Table Wedges ..... 113  
 Taco Holder ..... 86  
 Taco Server ..... 86  
 Tea Infuser Ball ..... 130  
 Tealights ..... 113  
 Teapot, Glass ..... 130  
 Teapot, S/S ..... 130  
 Tenderizer, Meat ..... 330  
**Thermal Circulator** ..... 394  
**Thermometer** ..... 287-289  
 Tickets, Coat Check ..... 117  
 Timer ..... 263  
 Tip Tray ..... 111  
**Toaster, Conveyor** ..... 398  
 Toilet Seat Covers & Dispenser ..... 353  
 Toilet Tissue Dispenser ..... 353  
 Toilet Tissue Holder ..... 353  
 Tomato Corer ..... 325, 327  
 Tomato Slicer, Countertop ..... 276, 374  
 Tongs, Flat, PC ..... 81, 308  
 Tongs, Ice, S/S ..... 80, 148, 309  
 Tongs, Pastry, S/S ..... 80, 309
- Tongs, Pizza ..... 269  
 Tongs, Plating, S/S ..... 299  
 Tongs, Pom S/S ..... 309  
 Tongs, Salad, S/S ..... 80, 309  
 Tongs, Serving, PC ..... 81, 308  
 Tongs, Serving, S/S ..... 80, 309  
 Tongs, Snail ..... 96, 110  
 Tongs, Spaghetti, PC ..... 81, 308  
 Tongs, Spaghetti, S/S ..... 80, 309  
 Tongs, Utility, S/S ..... 296, 306, 309  
 Toothpick Dispenser ..... 112  
 Tortilla Press ..... 91, 283  
**Tortilla Warmer** ..... 91  
 Towel, Cleaning ..... 156, 347  
**Trash Can Caddy** ..... 337  
 Trash Can Cart, Slender ..... 336  
**Trash Cans & Lids, Round** ..... 337, 339  
**Trash Cans & Lids, Slender** ..... 336  
**Trash Cans & Lids, Square** ..... 339  
 Tray Stand ..... 104  
 Tray, Dining, Alu. .... 106  
 Tray, Dining, Fiberglass ..... 106  
 Tray, Dining, Plastic ..... 106  
 Tray, Dining, S/S ..... 106  
 Tray, Display, Acrylic ..... 137  
 Tray, Display, S/S ..... 77, 134  
 Tray, Ice Cube ..... 148  
 Tray, Mess ..... 106  
 Tray, Seafood ..... 97, 110, 135  
 Tray, Serving, Chrome Plated ..... 77, 105  
 Tray, Serving, Cork-Lined ..... 104, 154  
 Tray, Serving, Fiberglass ..... 104, 154  
 Tray, Serving, Rubber-Lined ..... 104, 154  
 Tray, Serving, S/S ..... 88, 105, 154  
 Tray, Tip ..... 111  
 TRI-GEN™ Cookware ..... 198-202  
 Trolley, Utility ..... 368  
 Tumbler, Plastic ..... 131  
 Turner, Cooking ..... 190-191, 297, 316-317  
 Turner, Pancake ..... 286, 332  
 Turner, Serving, S/S ..... 78, 332  
 Turning Slicer ..... 282  
 Tweezers, Fish Bone ..... 331  
 Twist & Out™ ..... 145, 329
- U**  
 Underliner ..... 90, 208  
 Urinal Screen ..... 353  
**Utility Cart** ..... 368  
**Utility Pail** ..... 286, 347  
 Utility Trolley ..... 368
- V**  
**Vacuum Sealer** ..... 395  
 Vegetable Peeler ..... 325, 329  
 Vietnamese Coffee Infuser ..... 87, 132  
**Virtuoso™** ..... 64, 74, 124
- W**  
**Waste Basket** ..... 336  
 Waste Can, Mini ..... 112  
 Waste Receptacle ..... 339  
**Water Boiler, Electric** ..... 386  
 Water Pan ..... 64-70, 225  
 Water Pan, Electric ..... 71, 386  
 Whip, S/S ..... 310  
**Whipped Cream Dispenser** ..... 253, 281, 298  
 Whisk ..... 310, 311  
 Winco® Prime ..... 222, 228, 300-303, 333  
 Wine Service ..... 103, 153  
 Wipes Canister Bracket ..... 345  
 Wire Grate, Sheet Pan ..... 239  
 Wire Grate, Steam Table Pan ..... 227  
 Wok ..... 208  
 Wok Stand ..... 208  
 Wok, Mini ..... 82, 84
- Z**  
 Zester ..... 109, 325-326



# POS MERCHANDISING OPTIONS



Front



Back



Perfect for 5-piece place setting

## FLATWARE DISPLAY FRAME

### SIGNATURE CHEF

## CHEF APPAREL SHELF DISPLAY

FREE with qualifying order

*1 display per location*



## CUTLERY DISPLAY RACKS

### ACERO

### STÄL

### SOF-TEK™



**FREE with  
qualifying order**

*1 display per location*

Each cutlery rack includes hooks to hang product, (1) header sign and (2) header clips.

# APPAREL SIZING GUIDE

All measurements are in inches

## CHEF JACKETS

UNIVERSAL FIT	UNF-5W(Series)	S	M	L	XL	XXL	3XL
	Neck	16	17.5	19	20.5	22	53.5
	Chest	37-39	40-42	43-45	46-49	50-53	54-57
	Sleeve	37	34.75	35.5	36.5	37.5	38.5
	Hip	39-41	42-44	45-47	48-51	52-55	56-59

MEN'S TAPERED FIT	UNF-6 & 10 (Series)	S	M	L	XL	XXL	3XL	4XL
	Neck	16	16.75	17.5	18.25	19	19.75	20.5
	Chest	37-39	40-42	43-45	46-48	49-51	52-54	55-57
	Sleeve	33	34	35	36	37	38	39
	Hip	39-41	42-44	45-47	48-50	51-53	54-56	57-59

WOMEN'S TAPERED FIT	UNF-7(Series)	S	M	L
	Neck	13-14	14-15	15-16
	Chest	30.5-34	34.5-38	38.5-42
	Sleeve	31	32	33
	Waist	24.5-28	28.5-32	32.5-36
Hip	37.5	41	44.5	

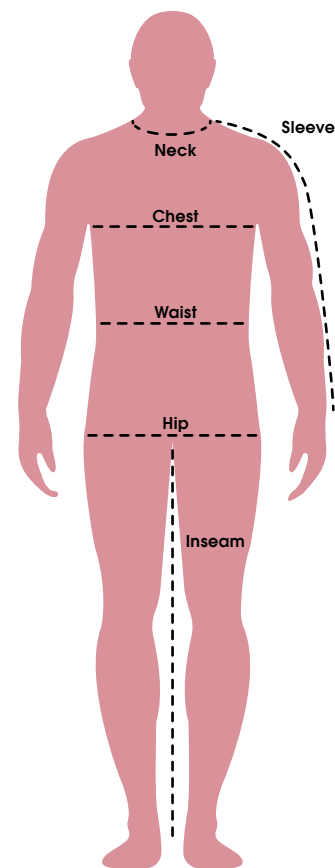

## SHIRTS

TAPERED FIT VENTILATED	UNF-9(Series)	S	M	L	XL	XXL	3XL
	Neck	16	17.25	18.5	19.75	21	22
	Chest	36.5-39	40-42.5	43.5-46	47-49.5	50.5-53	53.5-56
	Sleeve	22	23	24	25	26	27
	Hip	37.5-40	41-43.5	44.5-47	48-50.5	51.5-54	54.5-57

SNAP-BUTTON	UNF-1(Series)	S	M	L	XL	XXL	3XL	4XL
	Neck	16	16.75	17.5	18.25	19	19.75	20.5
	Chest	36.5-39	40-42.5	43.5-46	47-49.5	50.5-53	54-56.5	57.5-60
	Sleeve	18	19.25	20.5	21.75	23	24.25	25.5
	Hip	37.5-40	41-43.5	44.5-47	48-50.5	51.5-54	55-57.5	58.5-61

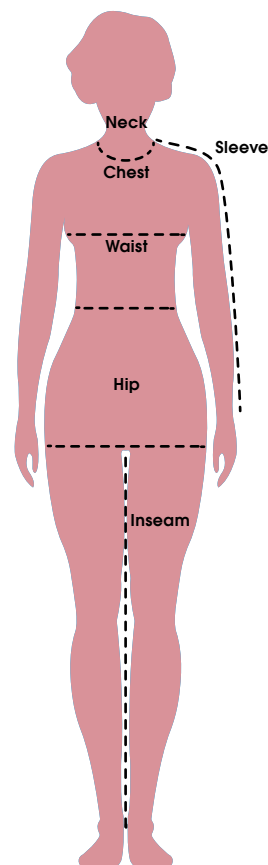

## PANTS

WOMEN'S	UNF-8K (Series)	S	M	L
	Waist	29-31	31-33	33-35
	Hip	39-40	41-42	43-44
	Inseam	31	31	32

HOUNDSTOOTH	UNF-4K (Series)	S	M	L	XL	XXL
	Waist	27-30.5	31-34.5	35-38.5	39-42.5	43-46.5
	Hip	34-37	38-41	42-45	46-49	50-53
	Inseam	30	31	32	33	34

BLACK & CHALKSTRIPE	UNF-2K, 3C, 11K (Series)	XS	S	M	L	XL	XXL
	Waist	24-28.5	29-32	32.5-35.5	36-39	39.5-42.5	43-46
	Hip	33-35.5	36-38	38.5-40.5	41-43	43.5-45.5	46-48
	Inseam	27	29	30	31	32	33

## LIMITED WARRANTY ~ ELECTRIC AND GAS EQUIPMENT



WINCO®/DWL International Trading, LLC warrants to the original purchaser of new electrical and gas equipment of our manufacture, when installed properly within USA and Canada, and subjected to normal use, is free from defects in material or workmanship for a period of one (1) year. Coverage for customers outside of the USA and Canada will be for parts only.

Determination of repair or replacement will be at the sole discretion of Winco.

**EXCLUSIONS:** Light bulbs, blades or coatings are not covered under said warranty. The labor warranty is one (1) year from original purchase date from dealer, or 18 months from Winco shipment date, whichever date occurs first.

**WINCO'S OBLIGATION AND LIABILITY UNDER THIS WARRANTY IS EXPRESSLY LIMITED TO REPAIRING AND REPLACING EQUIPMENT THAT PROVES TO BE DEFECTIVE IN MATERIAL OR WORKMANSHIP, WITHIN THE APPLICABLE WARRANTY PERIOD.**

**IN NO EVENT SHALL WINCO BE LIABLE FOR INCIDENTAL OR CONSEQUENTIAL DAMAGES TO BUYER OR ANY THIRD PARTY, INCLUDING AND WITHOUT LIMITATION: LOSS OF PROPERTY, PERSONAL INJURY, LOSS OF BUSINESS OR PROFITS, OTHER ECONOMIC LOSSES, OR STATUTORY OR EXEMPLARY DAMAGES, WHETHER IN NEGLIGENCE, WARRANTY, STRICT LIABILITY, OR OTHERWISE.**

This warranty applies only to the first purchaser from a retail dealer. No warranty is given to subsequent transferees. A copy of the original receipt or proof of purchase directly from Winco or Winco's authorized dealer/distributor is required for warranty coverage. **This warranty is not in force until such time as a properly completed and digitally signed Installation/Warranty Registration has been received by WINCO within 30 days from the date of installation.**

This warranty is void or does not cover damage caused by improper installation and/or use, neglect, failure to properly maintain, modifications, damage due to excessive water or fire, serial plate is defaced, product is installed in a prison or correctional facility, or normal wear. Periodic maintenance is not covered.

DO NOT send unit to WINCO without first contacting our customer service department.

To submit an equipment warranty claim, contact Winco/DWL International Trading, LLC at: [EquipService@wincous.com](mailto:EquipService@wincous.com)

## LIMITED WARRANTY ~ SHELVING

WINCO®/DWL International Trading, LLC warrants that shelving products of our manufacture, when properly installed within USA and Canada, and subjected to normal use, are free from defects in material or workmanship for a period of up to five (5) years.

Determination of repair or replacement will be at the sole discretion of Winco.

This warranty does not cover damage caused by improper installation and/or use, overloading, accident, improper storage, or neglect, alterations, modifications, or additions.

## LIMITED LIFETIME WARRANTY ~ CUTLERY AND TURNERS

All Winco®/DWL International Trading, LLC Acero™, Stal™ and Coolheat™ products are guaranteed against defects in workmanship and material for the life of the product.

Our products are designed to last when used as intended. The sole and exclusive remedy under this warranty is the replacement or repair of the defective product. Winco® reserves the right to inspect products for misuse.

### WARRANTY EXCLUSIONS

This warranty does not cover against misuse or any other subsequent conditions such as those attributable to the use of the product for purposes other than in accordance with generally accepted best industry practices. This includes, but is not limited to neglect, accident, alterations, surface markings, minor imperfections and normal wear.



To submit a warranty claim, contact Winco® at: [support@wincous.com](mailto:support@wincous.com)

**winco** | DWL International Trading, LLC

**New Jersey Headquarters**

65 Industrial Road,  
Lodi, NJ 07644

Phone: 1-888-946-2682  
Fax: 1-973-916-9959  
Email: [cs@winco.us](mailto:cs@winco.us)

**Florida Showroom & Distribution Center**

10800 NW 103rd Street, Bldg22, Ste 11  
Miami, FL 33178

Phone: 1-786-536-4656  
Fax: 1-973-916-9959  
Email: [cs@winco.us](mailto:cs@winco.us)

**California Distribution Center**

14950-14952 Valley View Ave.  
La Mirada, CA 90638

Phone: 1-888-946-2652  
Fax: 1-562-926-5678  
Email: [ca-cs@winco.us](mailto:ca-cs@winco.us)

*Check your order status online at [www.winco.us](http://www.winco.us)*

2020

WINCO-NOP

